



Programming tools for SAIA®PCD controllers

Programming, project planning and configuration of PLC-based systems

User Manual

Controls saia-burgess

Advantages of the PG5 programming tools

- **Program portability:** PG5 programs can run on all SAIA®PCD platforms.
- **Program organization by files** (containing several program blocks) simplifies the shared use of program files between several SAIA®PCD controllers.
- **Accepts existing PG3 and PG4 programs.**
- **Programming and debugging environments** united in each program editor.
- **Simple programming of terminal displays** with the HMI Editor.
- **Powerful instruction set** supported by macros and assembler directives.

Features of the PG5

- **Symbol Manager** administers all local, global and network symbols or symbol groups. Automatic address allocation largely dispenses with the need for fixed addressing.
- **Project Manager** administers complex installations of networked PCDs, including displays and documentation.
- **Online functions** for commissioning and error detection via Ethernet-TCP/IP, SAIA®S-Bus, modem, etc.
- **Integrated programming environments:**
 - FUPLA (function block diagram)
 - S-Edit (instruction list IL)
 - GRAFTEC (sequential function chart)
- **Integrated network editors** for SAIA®S-Bus, PROFIBUS DP and FMS, LONWORKS®.
- **Extensive additional libraries** broaden the scope of PG5 functions.

Contents

	Preface	
1	PCD – Quick-start	1-3
2	Project management	2-3
3	PCD - Resources	3-3
4	Program with FUPLA	4-3
5	Program structures	5-3
6	Graftec programming	6-3
7	Instruction list programming (IL)	7-3
8	Additional tools	8-3
9	Saia Networks	9-2
10	Profi-S-Bus	10-2
11	Ether-S-Bus	11-2
12	Profi-S-IO	12-2

Preface

This document is intended as an introduction to SAIA®PCD programmable controllers, rather than as a detailed commissioning manual. It therefore concentrates on the essential points for users who wish to acquire practical expertise quickly. For more comprehensive information, please refer to the help supplied by the programming tool itself, or to the detailed manuals that will be found on the documentation CD.

To ensure ideal conditions for your training, we advise you to obtain the following programs, documentation and material:

- CD PG5 version 1.4
- Documentation CD 26/803
- 1 x PCD2.M480¹ controller
- 1 x PCD2.E110 module with 8 digital inputs
- 1 x PCD2.A400 module with 8 digital outputs
- 1 x PCD8.K111 programming cable

All the necessary instructions for installing PG5 1.4 on your computer are provided on the PG5 version 1.4 CD (see under: CD:\PG5\ InstallationGuide_F.htm).

Please also note that all the English names of menus, instructions, options and buttons present in the PG5 program are reproduced in *italics* in this manual.

We wish you every success with your training and with future projects involving SAIA®PCD products.

Your partner Saia-Burgess Controls Ltd.

¹ an other PCD may also be suitable

Contents

1	PCD – QUICK-START	3
1.1	Introduction	3
1.2	Preparing the hardware.....	4
1.2.1	Example: Stairway lighting	4
1.2.2	Connection diagram of PCD2.M480	4
1.2.3	PCD2.M480 equipment	5
1.2.4	Wiring.....	5
1.3	Editing the program	6
1.3.1	Software Installation.....	6
1.3.2	Starting the PG5	6
1.3.3	Opening a new project.....	6
1.3.4	Configuration.....	8
1.3.5	Adding a program file.....	10
1.3.6	Opening a file	11
1.3.7	Editing a program	11
1.4	Running and testing the program	15
1.4.1	Building the program (<i>Build</i>).....	15
1.4.2	Downloading the program into the PCD (<i>Download</i>)	15
1.5	Finding and correcting errors (<i>Debugging</i>).....	16
1.6	Correcting a program	17

1 PCD – Quick-start

1.1 Introduction

As your first point of contact with PCD equipment, we propose a direct approach: tackling the production of a small real-life application. Even without any experience of SAIA products, this is easy to do. Everything is set out in detail in this quick-start chapter.

This example shows how to commission a PCD2.M480. Programming and testing using the PG5 programming tools.

Subsequent chapters in this document repeat in more detail the contents of this quick-start chapter, and provide much more information such as descriptions of available symbols, program structures and instruction list programming.

1.2 Preparing the hardware

1.2.1 Example: Stairway lighting

The commissioning of a PCD is illustrated using stairway lighting as an example. The building has a ground floor and three upper storeys. Each level has a push-button for switching the lights on. By briefly pressing any of these buttons, all 4 lights in the stairway will be switched on for a period of 5 minutes.

The push-buttons are connected to the 4 inputs of the PCD: I0, I1, I2 and I3.

The 4 lights are switched on/off via a relay. The relay is controlled via a single output (O32) on the PCD.

1.2.2 Connection diagram of PCD2.M480

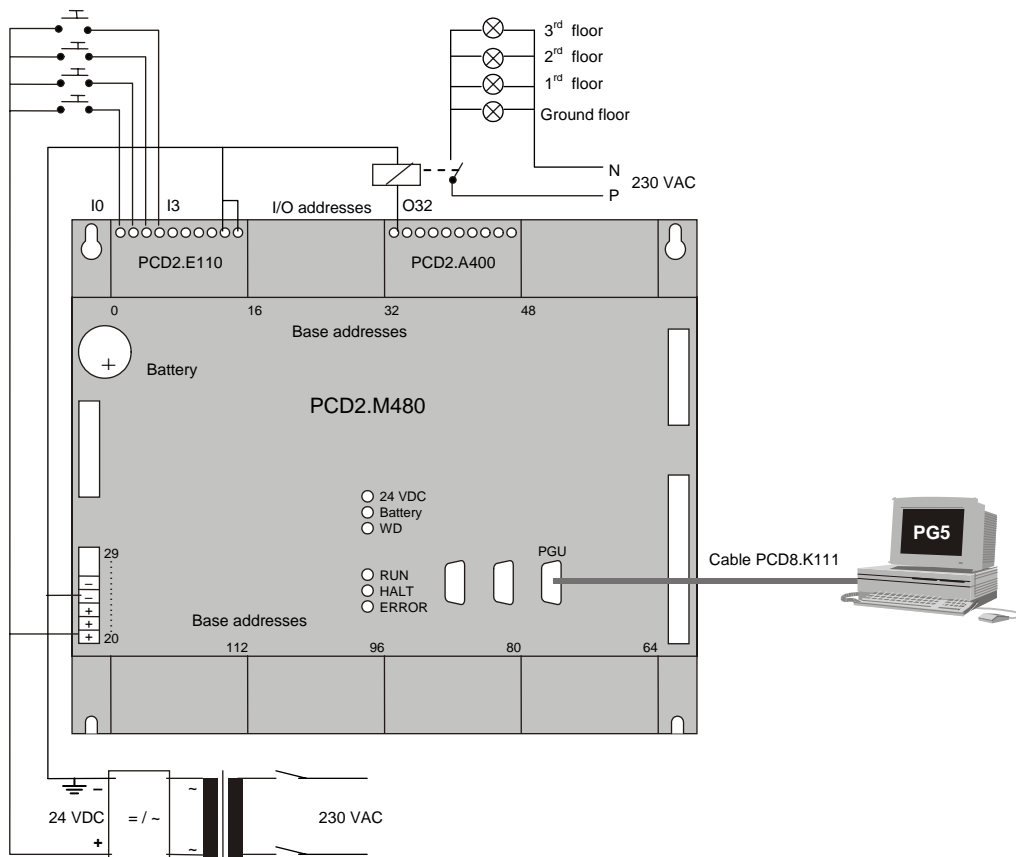

1.2.3 PCD2.M480 equipment

1. Insert the supplied 3.0 V lithium battery.
2. Plug a PCD2.E110 module into socket 1 (addresses 0 to 15).
3. Push the module towards the middle of the device until the end stop and engage latch. This provides 8 digital inputs for 24 VDC with addresses I0 to I7. Only inputs I0 to I4 will be used.
4. Plug a PCD2.A400 module into socket 3 (addresses 32 to 47) as previously described. This provides 8 digital outputs (O32 to O39) for 24 VDC / 0.5 A. Only output O32 will be used.

1.2.4 Wiring

1. Connect the 24 VDC supply to screw terminals 20 (+) and 23 (-). The following supply voltages are allowed: 24 VDC $\pm 20\%$ smoothed or 19 VAC $\pm 15\%$ full-wave rectified
2. The four inputs used are connected according to the hardware description of the PCD2.E110 module. Connect the 4 push-button switches to terminals 0 to 3. Terminals 8 and 9 are connected to the power supply negative.

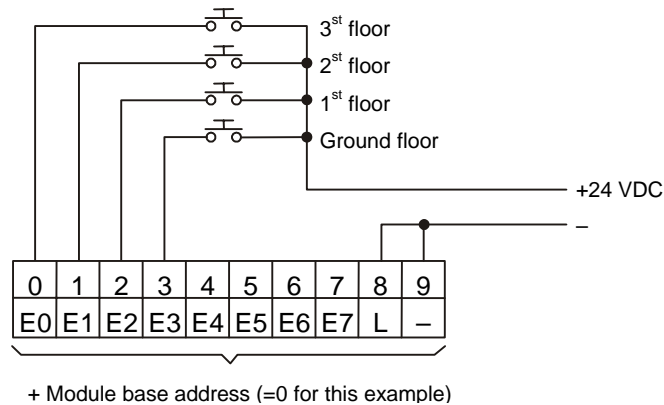

3. Connect terminal 0 to the relay coil, terminal 8 to the 24 VDC supply positive, and terminal 9 to the supply negative.

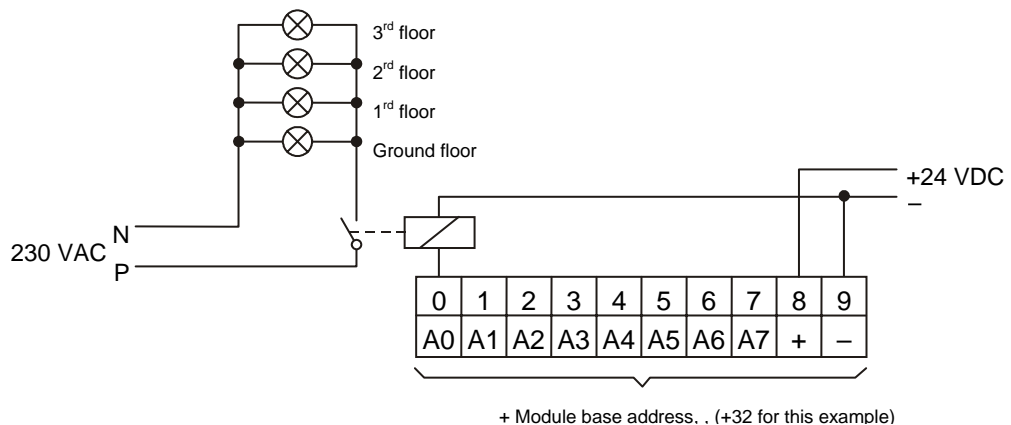

4. Connect the PC's RS 232 interface (COM port) to the PCD's PGU connector. PCD8.K111 cable should be used for this purpose.

N.B: For more detailed information about hardware assembly and wiring, please refer to your PCD hardware manual.

1.3 Editing the program

1.3.1 Software Installation

Install the PG5 programming tool for SAIA@PCD on the PC (if this has not already been installed), following the instructions supplied with the CD (cd:\PG5\ InstallationGuide_E.htm).

1.3.2 Starting the PG5

Start the PG5's Project Manager:

Start --> Programs --> SAIA PG5 V1.4 --> Project Manager

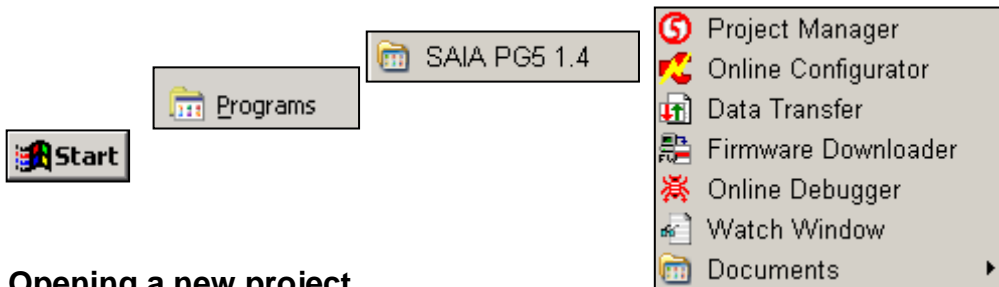

1.3.3 Opening a new project

Before starting to write a new program, a new or existing project must be opened that contains the necessary definitions, a few configuration parameters and the files needed for the user program.

If the project does not yet exist, select *Project, New...*, define the name of the new project in the *Project Name* field, check the *Create CPU* option and confirm with the *OK* button.

Make a new project

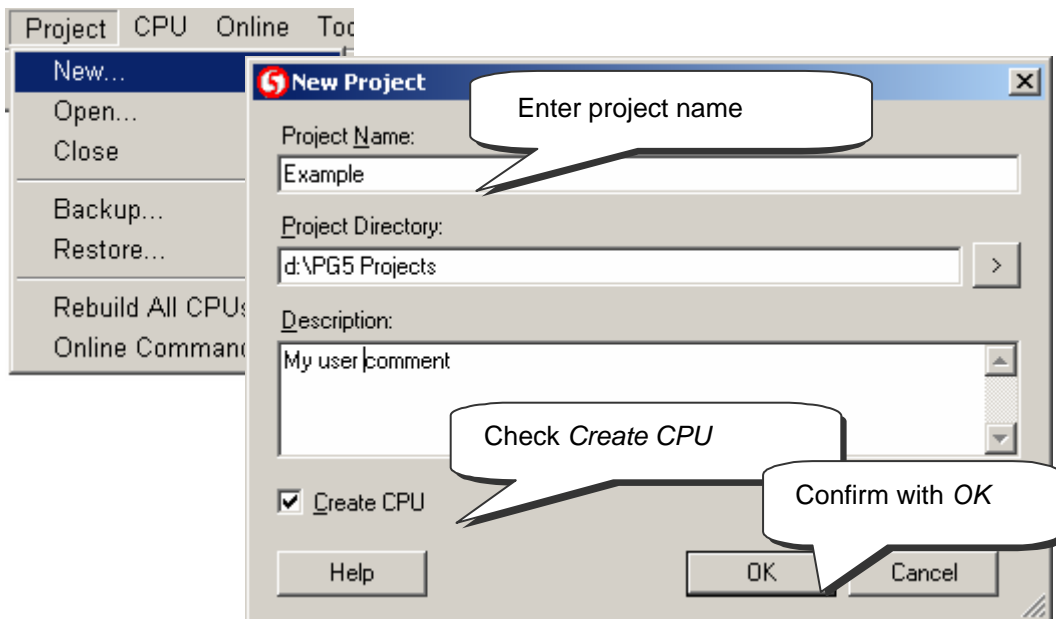

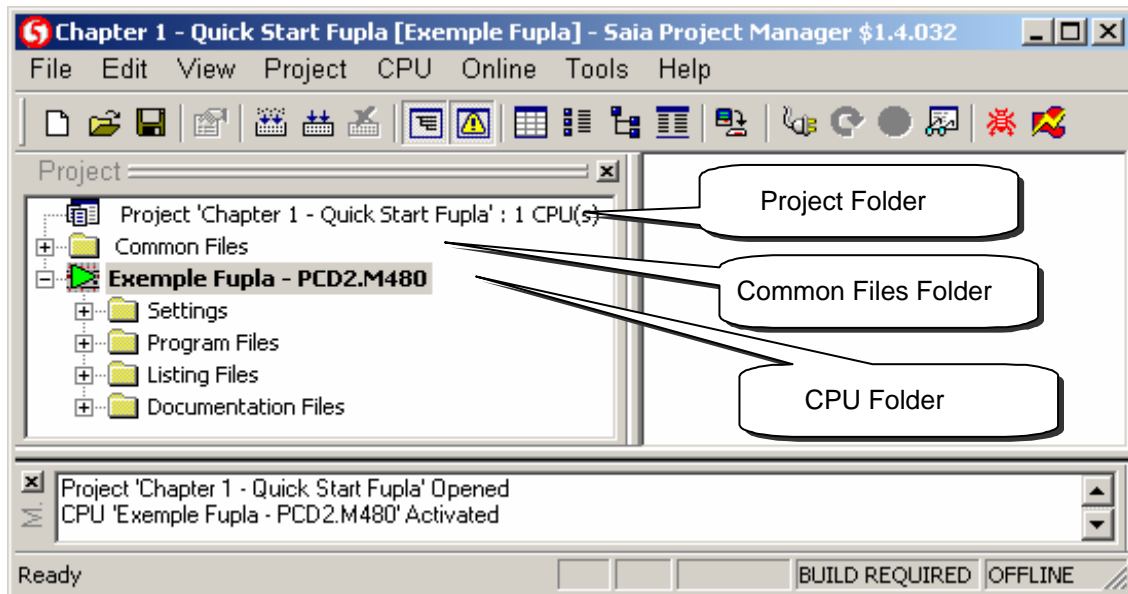

The *SAIA Project Manager* window is already displayed. The *Project* window shows the structure of the new project. (If this window is not yet displayed, use the *View, Project Tree* menu command).

Folders in the *Project* window contain project information, which is arranged according to certain criteria:

- The name of the main folder shows the project name and the number of CPUs used in the project.
- Modules that are shared by several the CPUs can be stored in the *Common Files* folder.
- Next are the CPU folders (each CPU corresponds to a PCD).

Every CPU folder contains the following sub-folders:

- *Settings*, contains the configuration for the programming tool and the PCD.
- *Program Files*, contains the program module files.
- *Listing Files*, contains files generated during the program build (*Build*). They are of less interest to the inexperienced user.

Opening an existing project

A project that already exists can be opened using the *Project, Open...* menu command. This searches for all project files (.5pj) in the project directory, and displays them in a list. Double-click on the project in the list, or select the project from the list and press the *Open* button. Alternatively, press the *Browse* button and find the Project or CPU file directly.

1.3.4 Configuration

Before you can work with a CPU in the project, configuration parameters must be defined, so that the programming tools and the generated user program will work with the PCD.

Under *Online settings* parameters can be set for communication between the PC and the PCD. Several possibilities are available. For this exercise the default protocol (PGU) will be selected, followed by the PC's serial port number (COM1).

Channel PGU (RS 232)

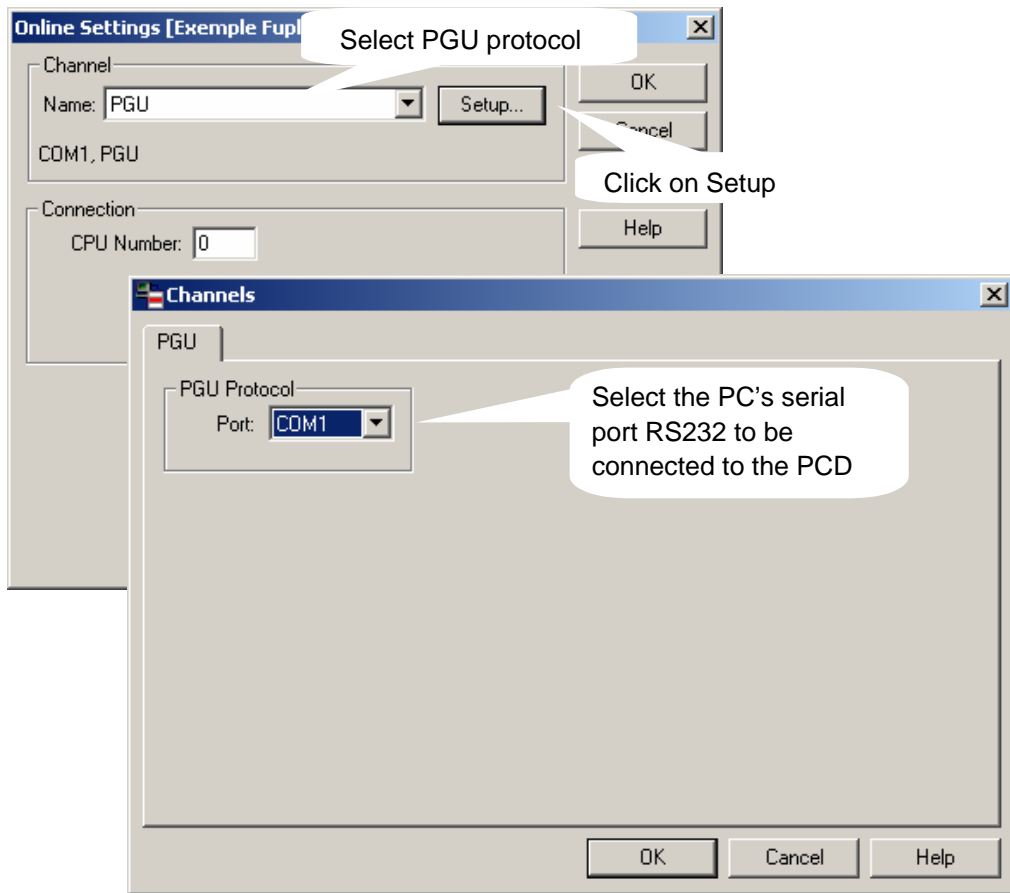

Channel S-Bus USB

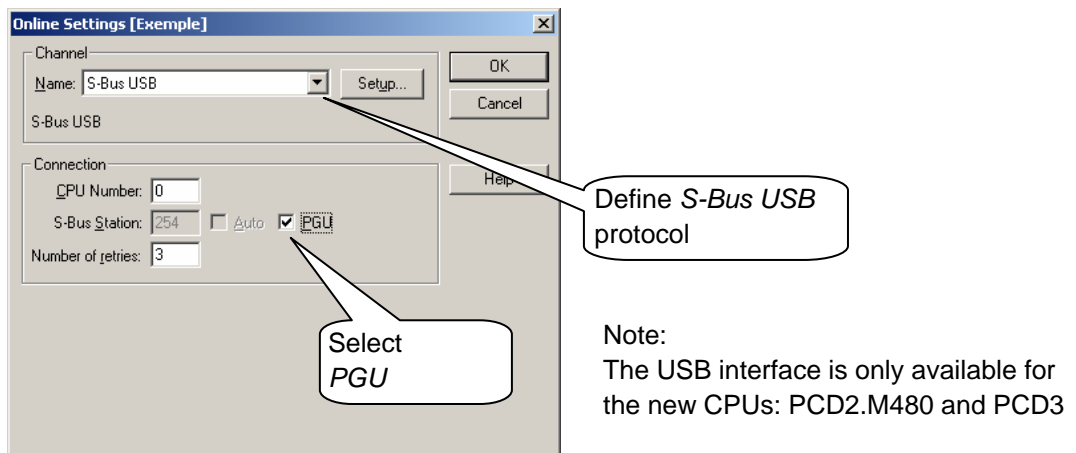

The PCD is configured using *Hardware Settings*. In this example, the options *Memory*, *S-Bus*, *Gateway*, *Modem* and *Password* are not required. However, it is important to select the correct PCD type and size of memory fitted. The **PCD2.M480** is always supplied with a standard 1024 Kbyte RAM.

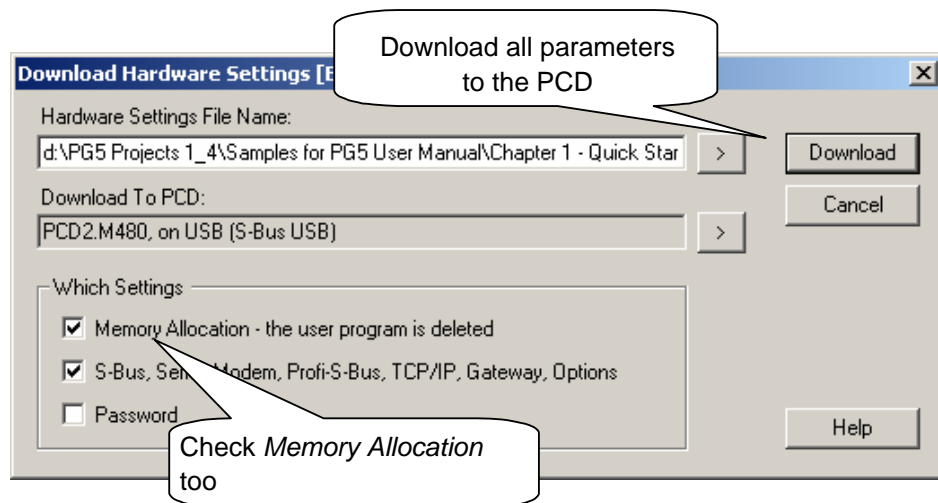
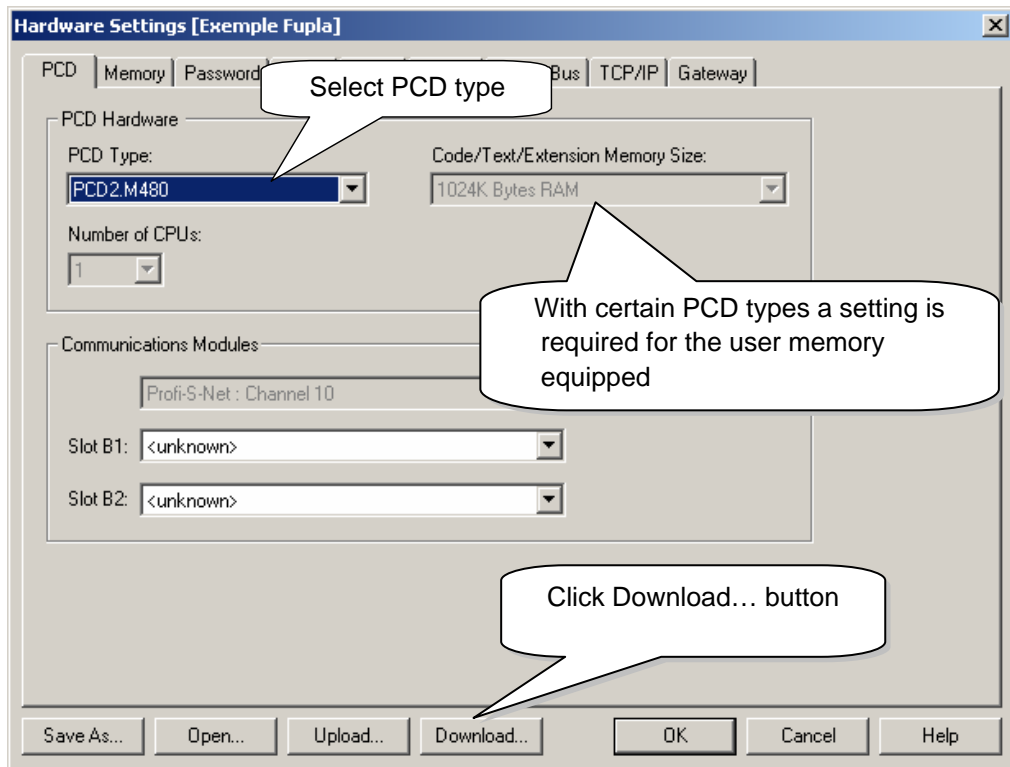

1.3.5 Adding a program file

PCD user programs are stored in one or more files. There are several ways of adding a program file:

In the *Project window*, select *Program Files*, click the right-hand mouse button to display the context menu and select *New...* (new file).

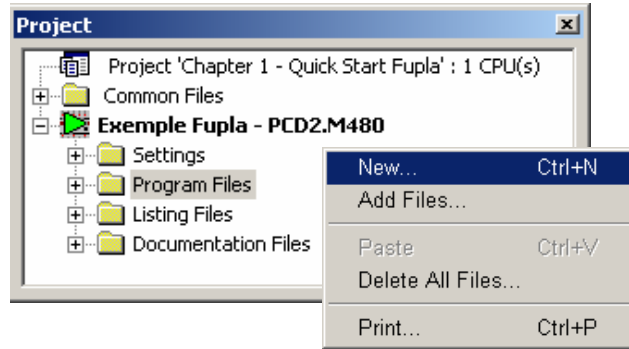

Alternative methods:

Click on the *New File* button on the toolbar, or use the *File, New...* menu command.

In the *New File* window the name and type of the module are defined: two very important items of information.

A number of editors are available for writing PCD user programs.

The user can choose which editor is best suited to the user program.

For this example it is

Fupla File (.fup).*

Fupla is a general purpose programming language.

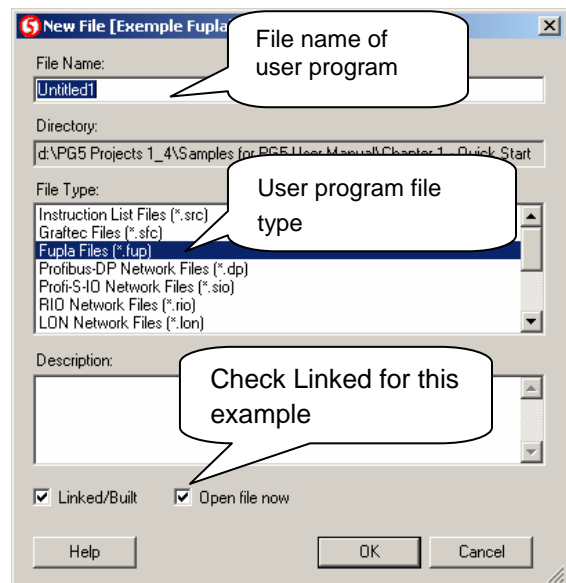

1.3.6 Opening a file

If the folder already contains a program file, the file can be opened as follows:
 In the *Project* window, open the Program Files folder and double-click on the relevant file. Alternatively, right-click on the file name to open the context menu and select *Open*.

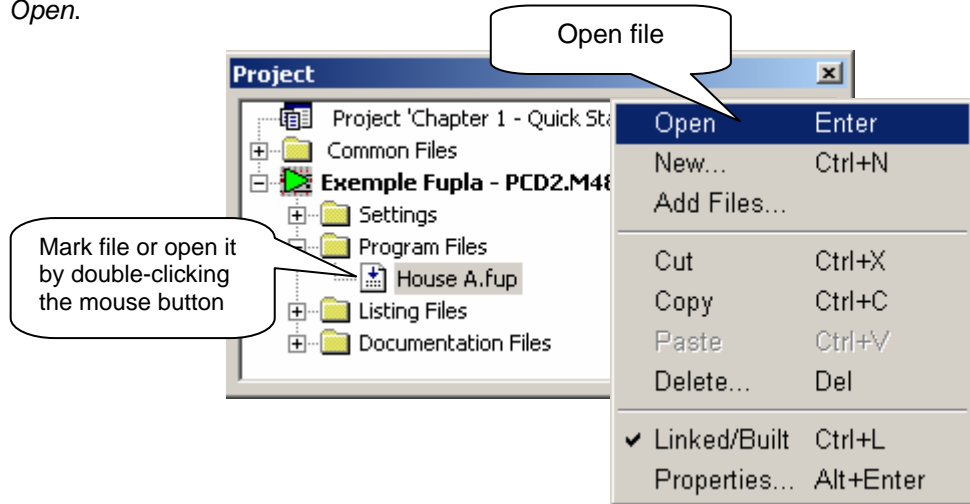

1.3.7 Editing a program

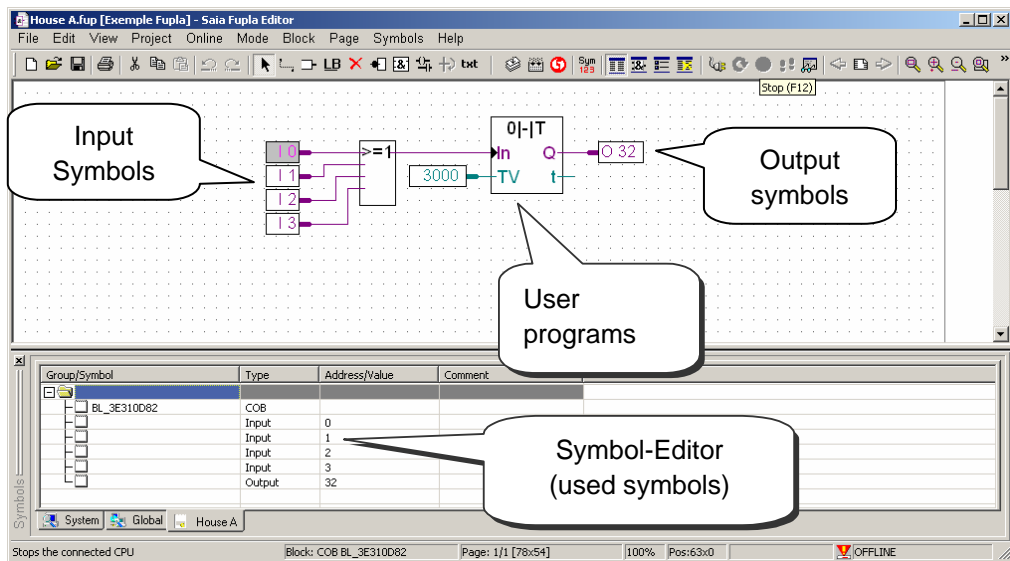

Editing symbols

Symbols reference the data needed by the PCD's user program, e.g. the stairway lighting switches. We edit symbols in the connectors on the Fupla page. 'Read' symbols are on the left, 'write' symbols are on the right.

This stairway lighting example has 4 light switches as inputs (I 0, I 1, I 2 and I 3) and one output (O 32) to drive the stairway lights. The required period of 5 minutes, during which stairway lighting will be on, must be entered in the input connector as a multiple of tenths of a second.

The value of this constant is therefore 3000 (5 min. x 60 sec. x 10 = 3000).

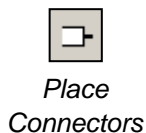

To add a connector and its symbol to a Fupla page, press the toolbar button *Place Connector* and position the mouse on the Fupla page. A 'read' input connector is added by clicking the left-hand mouse button. A 'write' output connector is added by holding down the *Shift* key and pressing the left-hand mouse button. The connector you have just added is ready to receive a symbol and a cursor is displayed inside the connector. If you do not wish to edit the symbol inside the connector straight away, press the *ESC* key and place the next connector.

To edit or modify a connector symbol already present on the Fupla page, select the connector by double clicking quickly. A cursor will be displayed inside the connector. It is now possible to enter the address I 0 to I 3, or output O 32, or the constant. Make sure you always leave a space between the letter I and the input address. The same applies for the output.



To edit the input symbols, 4 consecutive cells in the left-hand column of the program screen are marked with the mouse and addresses I 0 to I 3 are entered. The time constant 3000 (left) and output O 32 (right) are entered in the same way.

Please note that the address type (I or O) and address value (0 to 3 and 32) must be separated by a space character.

The symbols will immediately appear in the *Symbols* window of the Symbol Editor. If the symbol editor is not visible it can be displayed using the *View, Symbols* menu command or by pressing the *Show/Hide Symbol Editor* toolbar button:

Note:

As a default, each new page may already provide margins with connectors on the left and right. If you prefer new pages not to appear with these connectors, so that you can place them yourself at your own convenience, please deactivate the corresponding option with menu: *View, Options..., Add Empty Side Connectors*.

To remove any empty connectors present on the left or right of the page, select menu: *Page, Remove Empty connectors*.

To place connectors once again on a blank page, select menu: *Page, Add Empty Side Connectors*.

Editing program functions

Program functions are entered in the area between the 'read' and 'write' connectors. This is done by positioning the graphical symbols of the function boxes (FBoxes) that are used to create user programs.

Function boxes are selected from the *FBox Selector* window.



Add Fbox

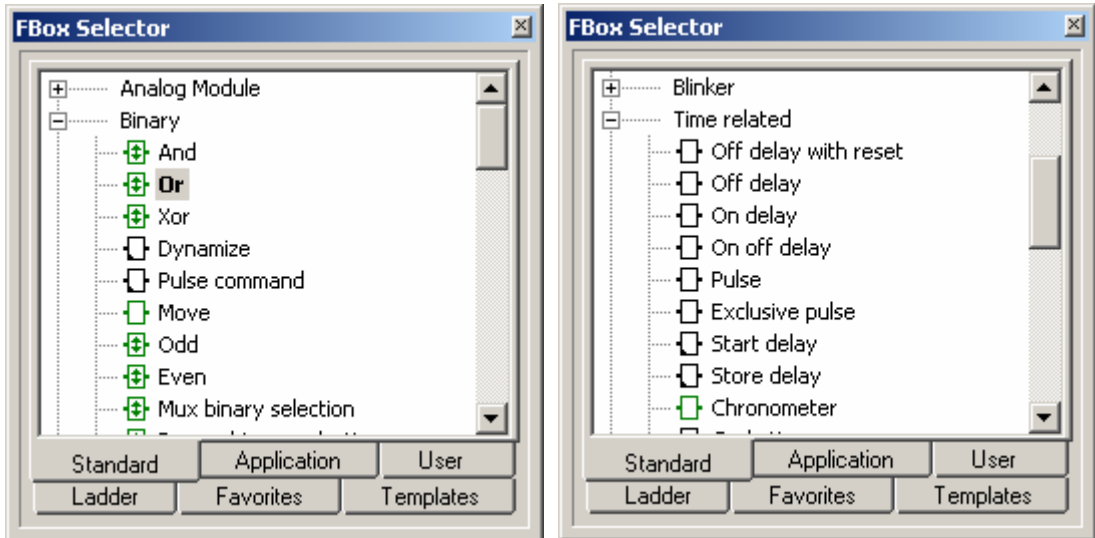

The first function required in this example serves to switch on the lighting in response to a short pulse from a stairway switch. This is an *OR* function, which is found in the *Binary* family in the *Standard* library.

The second function *Off delay* defines the 5 minute period during which the lights are on. It is found in the *Timer* family in the *Standard* library.

Further information on the chosen FBox can be found by right-clicking on the function in the *FBox Selector* window, and choosing the *FBox Info* context menu command.

When a function box has been selected from the *FBox Selection* window, the left-hand mouse button is used to place it in the edit window between symbol columns.

With certain function boxes, such as *OR* logic, the number of inputs can be selected. This is done by dragging the mouse vertically and clicking the left-hand mouse button when the number of inputs is correct.

Connecting function

Use this method when connection points are aligned horizontally

1. Press the *Select Mode* button
2. Place the mouse pointer over the FBox and press the left-hand mouse button.
3. Hold the button down and drag the FBox horizontally until the connection is made. Do not release the mouse button.
4. Drag the FBox back to its original position and release the mouse button.

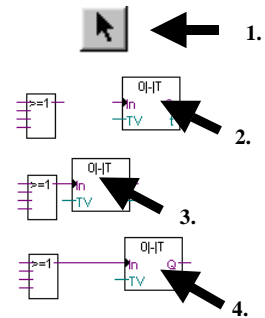

Use this method for the other connections

1. Press the *Auto Lines Mode* button
2. Click on the starting point with the left-hand mouse button and release it. Move the mouse pointer to the right as far as required and press the left-hand mouse button again.
3. Move the mouse vertically and click the left mouse button once more.
4. Move the mouse pointer to the FBox connector and press the left-hand mouse button again to finalise the connection.
5. If necessary, line drawing can be aborted by pressing the right-hand mouse button.

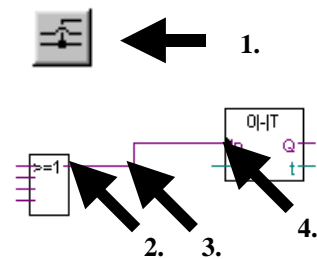

Deleting a line, function box, symbol or connector

Press the *Delete Mode* toolbar button and click on the line, FBox, Symbol or Connector to be deleted.



1.4 Running and testing the program

1.4.1 Building the program (*Build*)

Before the program executed by the PCD, it must be build (compiled, assembled and linked) using the Project Manager's *CPU, Rebuild All Files* menu command, or the *Rebuild All Files* toolbar button.



*Rebuild
All Files*

The results of the build are shown in the *Messages* window (Compiling, Assembling, Linking etc.). If the program has been correctly edited, the build function completes with the message: *Build successful. Total errors 0 Total warnings: 0*

Errors are indicated by a red error message. Most errors can be located in the user program by double-clicking on the error message.

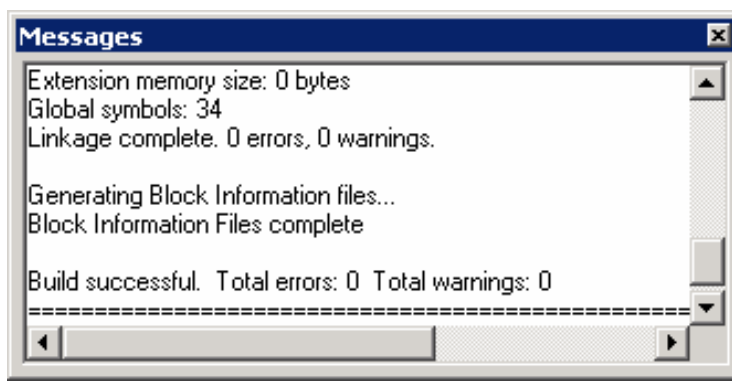

1.4.2 Downloading the program into the PCD (*Download*)

The user program is now ready. All that remains is to download it from the PC into the PCD. This is done using Project Manager's *Download Program* toolbar button or the *Online, Download Program* menu command.



*Download
Program*

If any communications problems arise, check the configuration settings (*Settings Online* and *Settings Hardware*) and the (PCD8.K111 or USB) cable connection between the PC and the PCD.

1.5 Finding and correcting errors (*Debugging*)

The first version of a program is not always perfect. A stringent test is always needed. Program testing is done using the same editor that was used to write the program.

1. Press the *Go On /Offline* button



2. Start program with the *Run* button

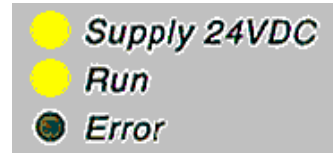

Observe the *RUN* LED on the PCD at the same time.



When the *Run* button is pressed, the *RUN LED* on the PCD should turn on because the PCD is now executing the user program.



When the *Stop* button is pressed, the *RUN LED* on the PCD should turn off because the PCD has stopped executing the program.

When the editor is *Online* and the PCD is in *RUN* mode, the state of each individual symbol can be displayed:

- The logical state of binary data is shown with a heavy or fine line (heavy = 1 and fine = 0)
- Other data values can be displayed by clicking the left-hand mouse button on the connection to show a *Probe* window: use the mouse to select the *Place Probe* button and the link.

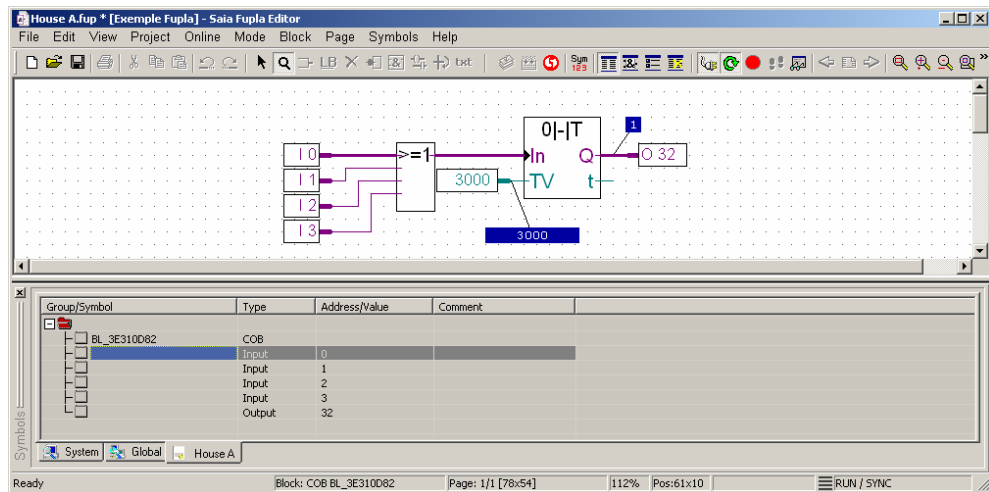

1.6 Correcting a program

To modify a program, proceed as follows:

1. Go offline (using the **Go On /Offline** button).
2. Modify the program.
3. Execute a new program build (with the **Build** button).
4. Download program to the PCD (with the **Download Program** button))



Contents

2	PROJECT MANAGEMENT	3
2.1	Introduction	3
2.2	Project organization	4
2.2.1	Example of application project.....	4
2.2.2	Saving the project to a PC	6
2.2.3	Compressing a project or CPU	6
2.2.4	Opening a project	7
2.2.5	Creating a new project.....	7
2.3	The <i>Project</i> window	8
2.3.1	Project folder	8
2.3.2	Common Files folder	9
2.3.3	CPU folder.....	9
2.3.4	Settings Online	10
2.3.5	Connection of PC to PCD.....	11
2.3.6	Hardware Settings	12
2.3.7	Software Settings.....	17
2.3.8	Program Files folder	19
2.3.9	File types	20
2.3.10	Files linked	21
2.3.11	Common files	21
2.4	Building the program	22
2.4.1	<i>Rebuild All</i> and <i>Build</i>	23
2.4.2	<i>Build</i> options.....	23
2.5	Messages window.....	24
2.6	Downloading the program into the PCD	25
2.6.1	Download options.....	26
2.6.2	Load program onto backup memory (Flash card).....	27
2.6.3	Backup memory and transfer of the application program.....	27
2.7	View window	27
2.7.1	Organization block structure.....	27
2.7.2	List of organization blocks	28
2.7.3	List of symbols	28
2.7.4	Cross-Reference	28
2.8	Program backup	29
2.9	Self downloading files.....	30
2.9.1	Prepare a ' <i>.sd5</i> ' file.....	30
2.9.2	Downloading a ' <i>.sd5</i> ' file	31

2 Project management

2.1 Introduction

Modern automation applications frequently comprise large numbers of controllers connected in networks. The PG5 therefore unites in a single project the programs and configurations of all PCD controllers within any one application. The PG5 Project Manager offers the user a global view of all the information that relates to a project.

2.2 Project organization

2.2.1 Example of application project

In practice, automated installations almost always comprise a number of local PCD programmable controllers connected in a communications network. Each PCD supports the control of a particular function within the project as a whole, such as: lighting management, heating control, ventilation control, or the automatic doors of an underground garage.

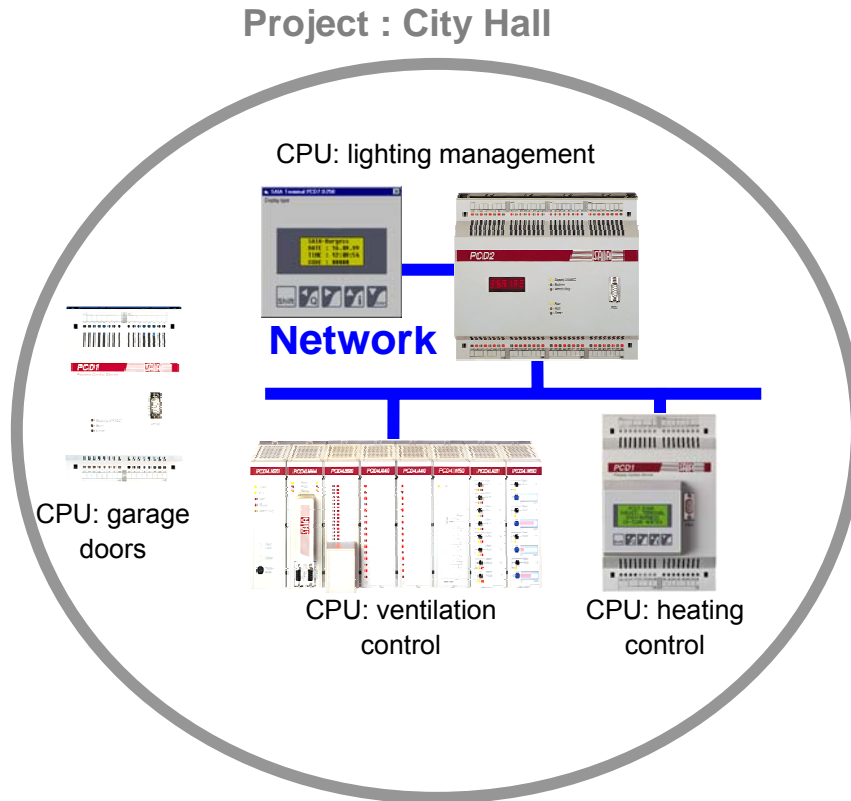

The PG5 programming tool unites in a single PG5 project all the PCD CPUs that belong to any one particular application.

A green triangle identifies the active CPU. All instructions for building, downloading and testing the program use the configuration and program files of the active CPU.

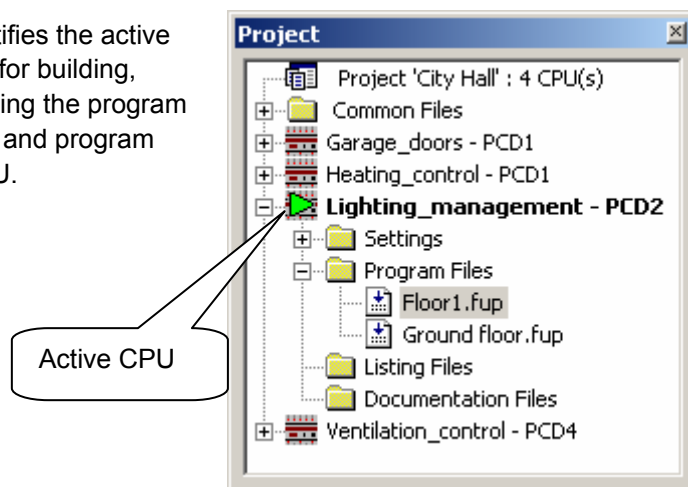

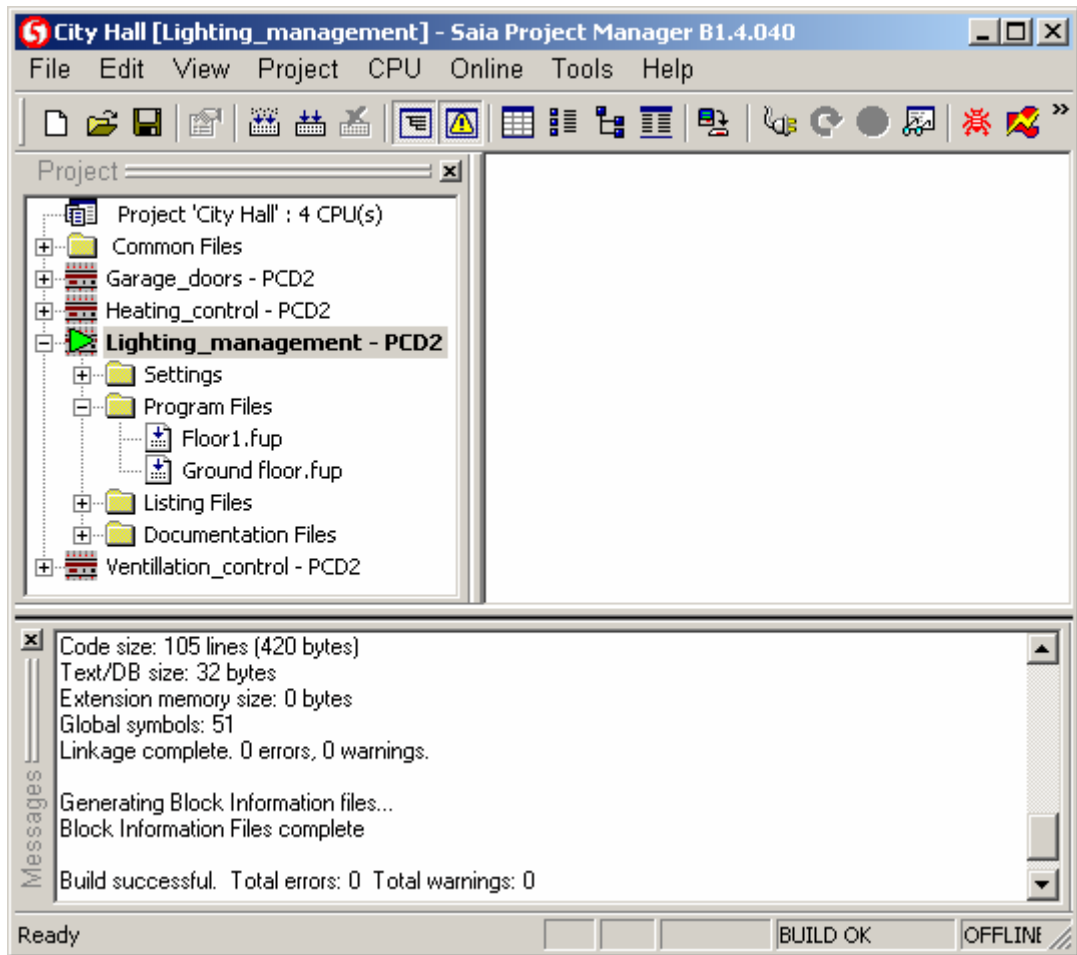

Project Manager has three windows:



Project Tree

The *Project* window shows the structure of the project with the PCD CPUs that make it up. To display this window, select menu path: *View, Project Tree*, or click on the *Project Tree* button.



Message Window

The *Message* window shows alarm and error messages generated during any build of the program. To display this window, select menu path: *View, Message Window*, or click on the *Message Window* button.

The *View* window shows the View list, block list, block structure or text files. It also allows symbols to be cross-referenced.

2.2.2 Saving the project to a PC

By default, projects are saved in directory **C:PG5 Projects 1_4**

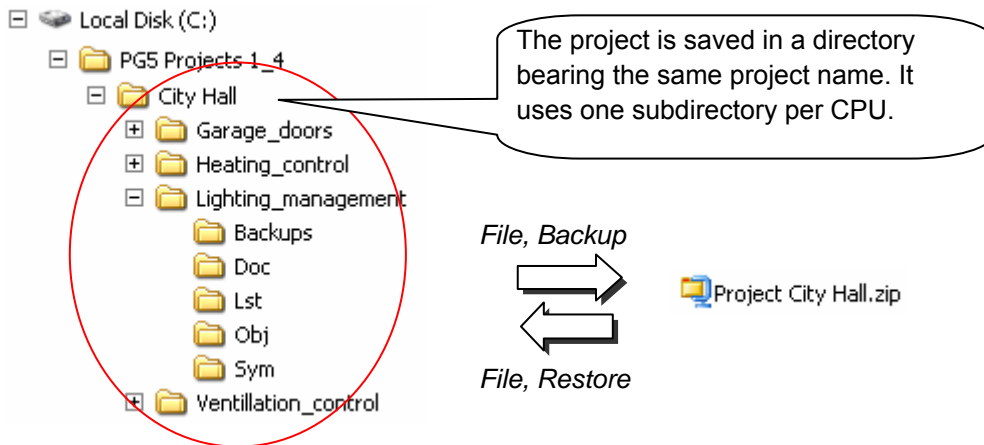

2.2.3 Compressing a project or CPU

When a project is saved, the entire structure of directories and the files they contain must be preserved. The simplest method is to compress the whole structure into a *.ZIP file using the *Backup* command. This is supported as follows:

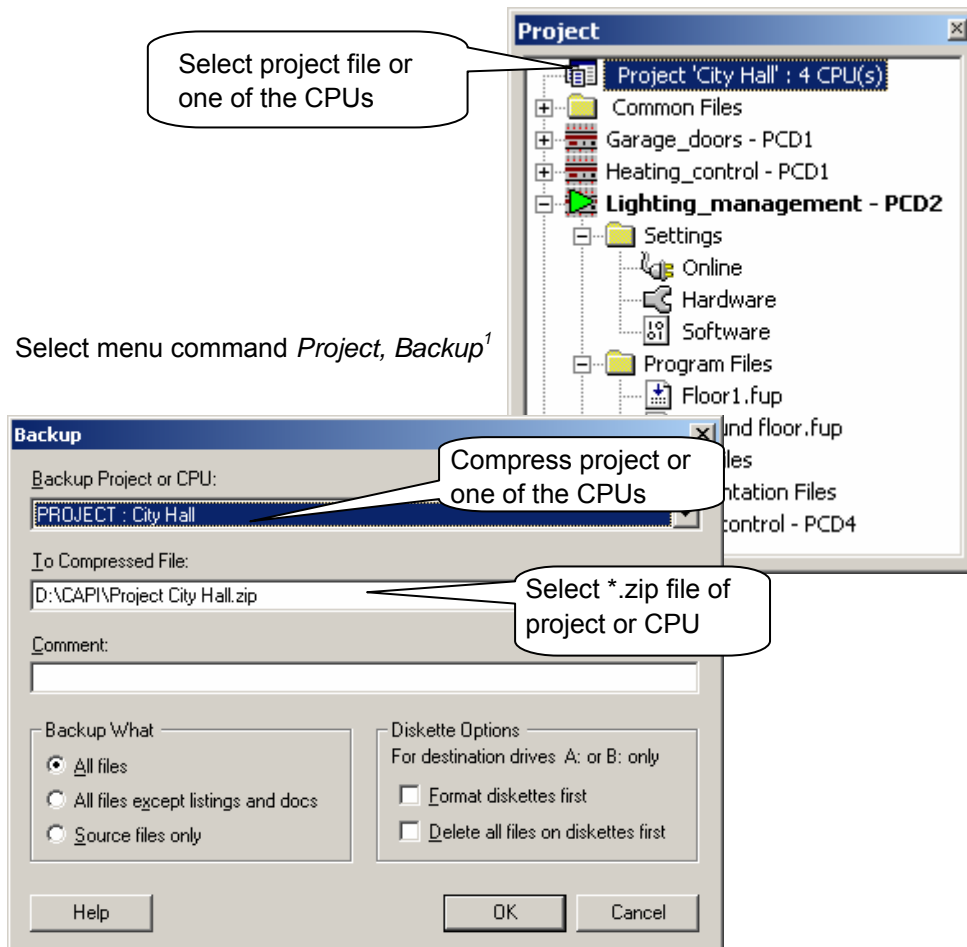

¹ The *Project, Restore* menu command lets you restore a project/CPU that has been saved in a *.ZIP file.

2.2.4 Opening a project

The PG5 is delivered with all the examples in this manual included. The *Project, Open...* menu command allows you to open them and try them out.

An existing project can be opened with command *Project, Open...*, This locates all the project files (.5pj) in the projects directory and displays them in a list. Double-click on one of the projects in the list or select a project and press the *Open* button. Alternatively, press the *Browse* button and look for the project file (.5pj) or CPU file (.5pc) directly.

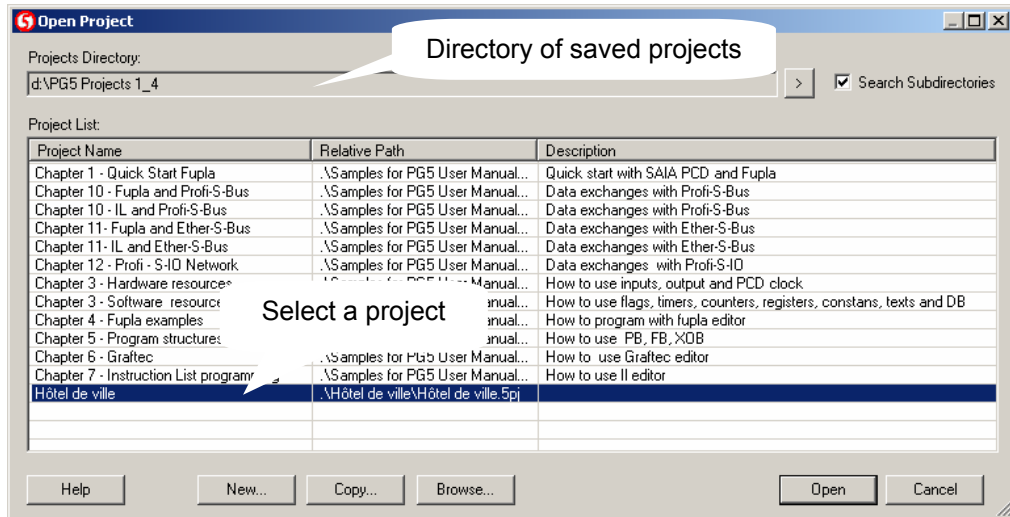

2.2.5 Creating a new project

To create a new project, use menu command *Project, New...*, define the name of the new project in the *Project Name* field, select the *Create CPU* option and confirm with the *OK* button.

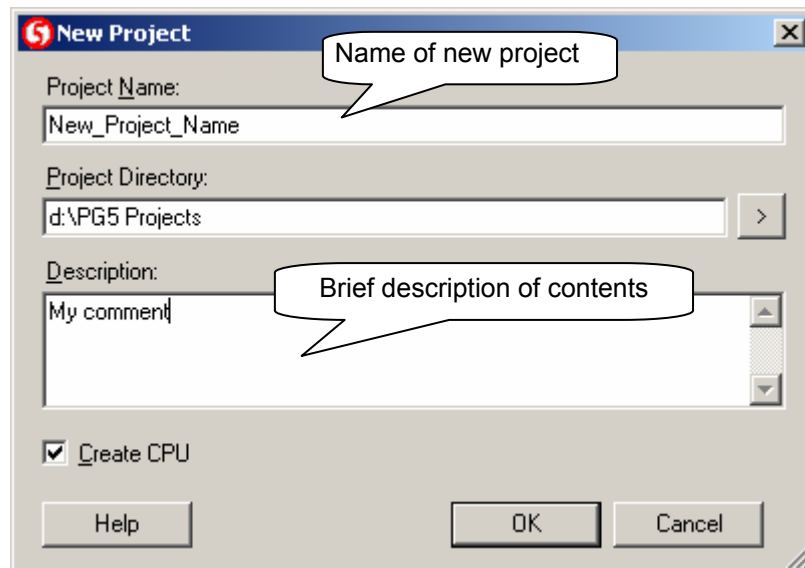

2.3 The *Project* window



Projekt Tree

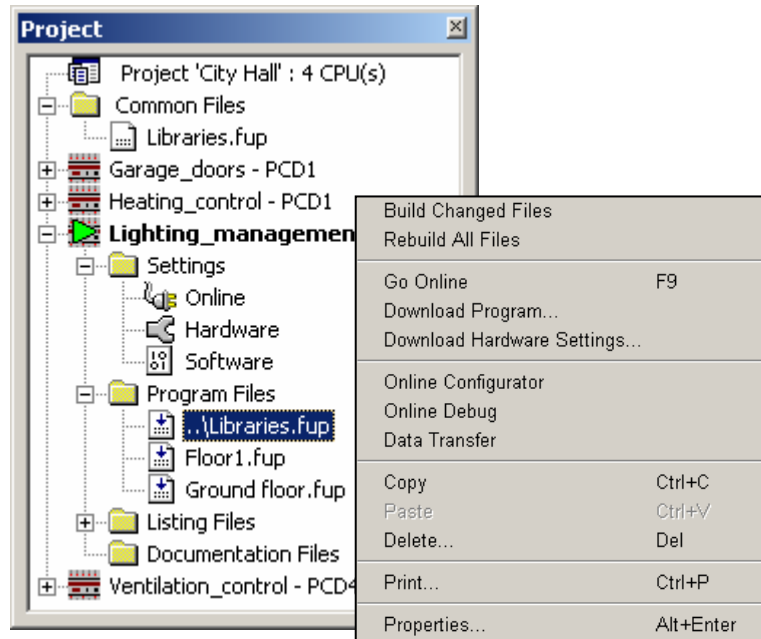

Folders in the *Project* window group together project information according to certain organizational criteria:

2.3.1 Project folder



The main folder shows the project with its name and how many CPUs it includes. To modify information in this folder, select the folder with the mouse and show the context menu with the right-hand mouse button.

<i>New CPU...</i>	Adds a new CPU to the project
<i>Import CPU...</i>	Imports CPUs from another PG5 project or from an old PG4 project
<i>Paste CPU</i>	Pastes a CPU with all its contents
<i>Copy Project...</i>	Copies a project with all its contents
<i>Backup...</i>	Backs up the project to a *.zip file
<i>Restore...</i>	Restores the project from a *.zip file
<i>Rebuild All CPUs Online Commands</i>	Commands for implementing a full project <i>Build</i> or <i>Download</i> .
<i>Print...</i>	
<i>Find...</i>	
<i>Properties</i>	Modify information specific to the project folder: project name, description, ...

2.3.2 Common Files folder

The *Common Files* folder is provided to hold modules common to more than one CPU in the project. To add a program file, select the folder and use *New File* from the context menu.

The *Add Files* item in the context menu can be used to import any type of PG5 program file, but can also import the application's commissioning and maintenance documents (in Word, Excel, etc.). These files are stored with the PG5 project and can be opened by double-clicking on them.

Note

Common files use the same *local symbols* in each CPU which uses the file, but the CPU's own *Global symbols* are used, so global symbols used in a common file can be different for each CPU.

2.3.3 CPU folder



Each CPU folder contains the configurations and programs for one controller in the project. To modify information in a CPU folder, right-click on it to show the context menu.

<i>Set Active</i> 	When a CPU is selected in the <i>Project</i> window, this command will make it the active CPU. The active CPU is identified by a green triangle. All commands from menus and buttons work with the active CPU.
<i>Rebuild Changed files</i> <i>Rebuild All Files</i>	Commands for doing a <i>Build</i> of the CPU selected in the <i>Project</i> window.
<i>Go Online</i> <i>Download Program</i> <i>Download Hardware Settings</i>	
<i>Online Configurator</i> <i>Online Debug</i> <i>Data Transfer</i>	
<i>Copy, Paste</i> <i>Delete</i>	Copies, pastes or deletes the CPU selected in the <i>Project</i> window
<i>Print...</i>	
<i>Properties</i>	Modify information specific to the CPU folder: CPU name, description, ...

Note: From the menu: *Tools, Options, General page*, the option *Activate CPU according to Project Tree location* is selected, the *SAIA Project Manager* will automatically activate the CPU according to the context in which it is used. The *Set Active* command cannot then be used and does not appear in the context menu.

2.3.4 Settings Online



The *Settings*, Online folder allows the CPU's communications parameters to be defined. A number of communications protocols are supported: PGU, S-Bus, Ethernet, etc. However, only the *PGU* and *S-Bus USB* protocol allows direct communication with the PCD that does not require configuration in the PCD's Hardware Settings.

Channel PGU (RS 232)

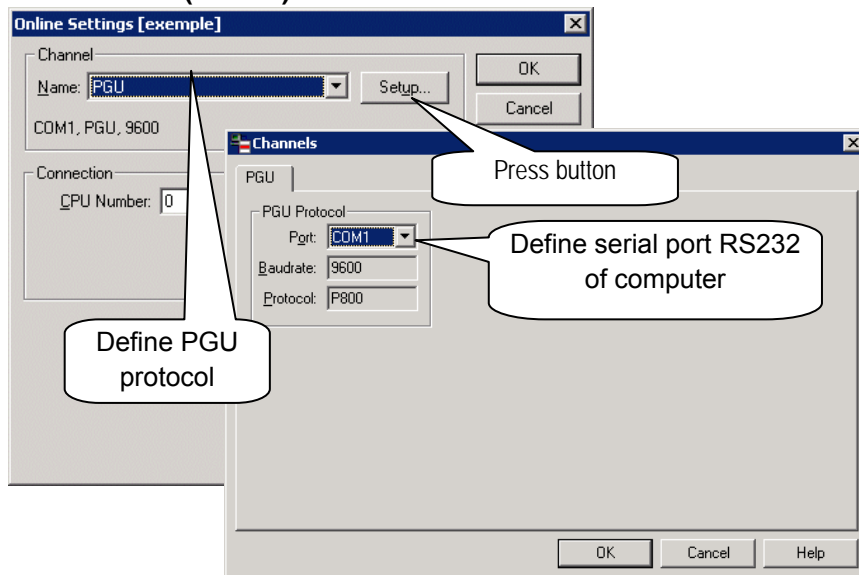

Channel S-Bus USB

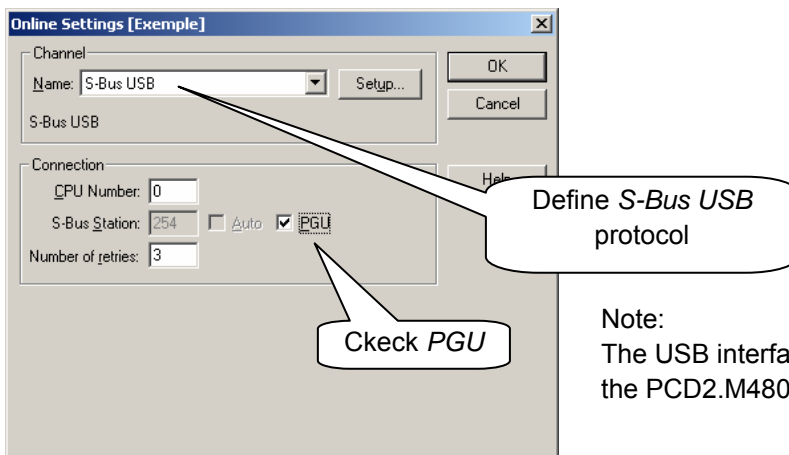

Note:
The USB interface is only available for the PCD2.M480 and PCD3

2.3.5 Connection of PC to PCD

Channel PGU (RS 232)

A PCD8.K111 cable provides the RS 232 link between the PC and the PCD. For more information about this cable, please see the PCD hardware manual.

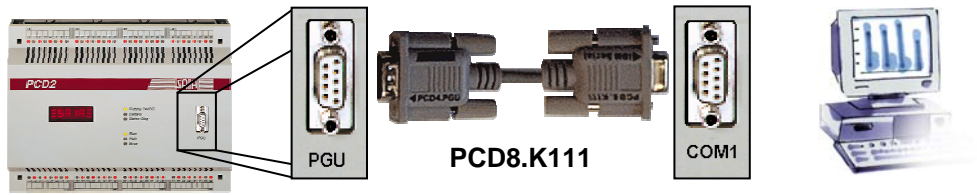

Channel S-Bus USB

The USB interface is only available for the CPU PCD2.M480 and PCD3



Online Configurator

Checking the connection

The *Online Configurator* button, or the *Tools, Online Configurator* menu command allows the connected PCD's settings to be viewed. If the information in red is shown, then communications is working perfectly.

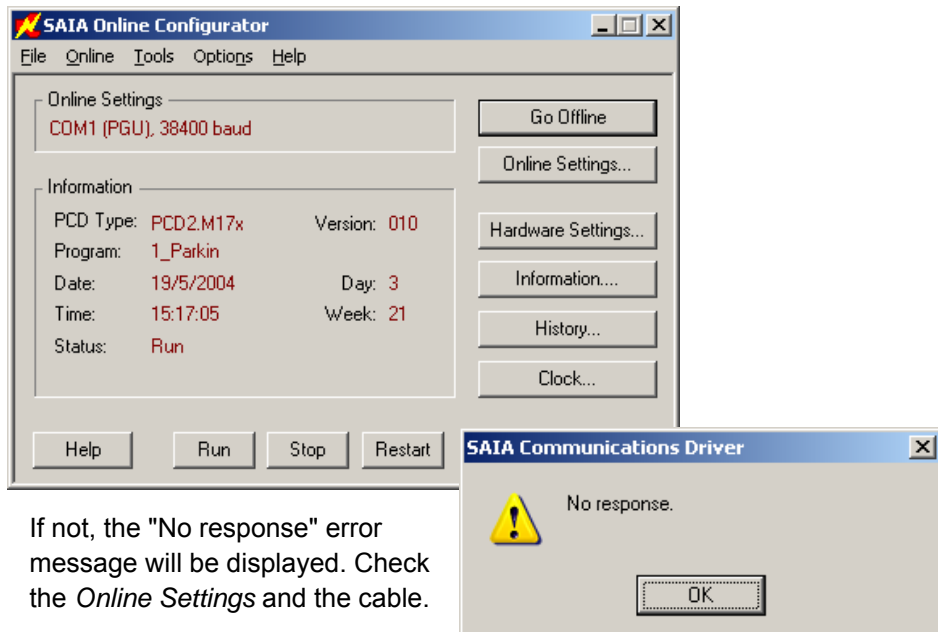

If not, the "No response" error message will be displayed. Check the *Online Settings* and the cable.

2.3.6 Hardware Settings



The *Hardware Settings* folder allows definition of the PCD controller's memory and communications parameters.

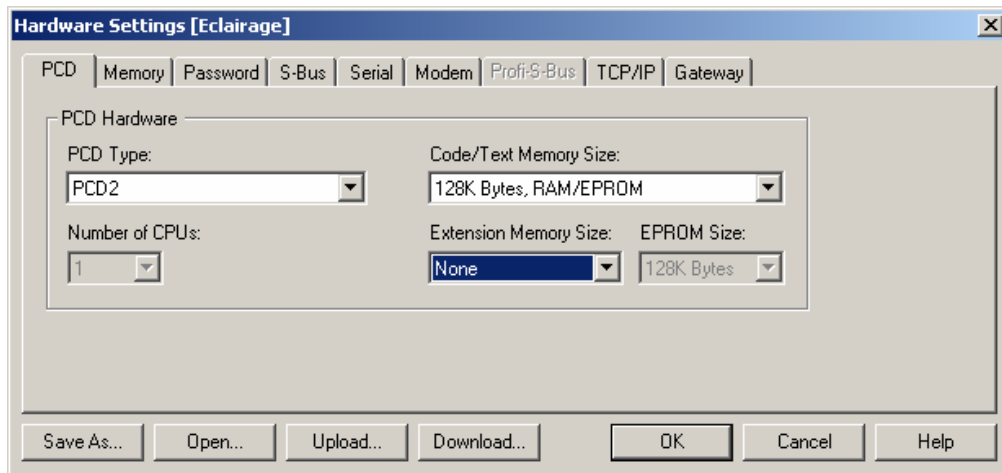

When a controller is used for the first time, or after adding new memory to the PCD, its memory must be configured. There are two ways of selecting the parameters of the above window:

- The first way is to select the *Upload* button and read View directly from the controller.
- The second way is to define the window's information with the help of the tables shown on the next two pages. The above example corresponds to the lines marked in bold on these tables.

The table below shows information about the memory jumpers. These jumpers must be set on the PCD's CPU card. For more information, please see the hardware manual.

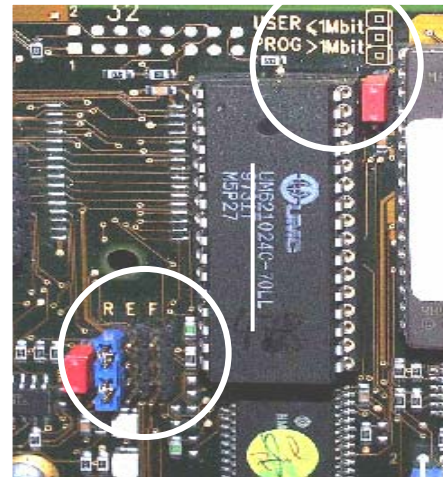

Memory jumpers in a PCD2.M120 equipped with LM621024 memory

PCD type	Memory	Stock number	Code/Text Memory Size	Extension Memory Size (RAM)	Jumper position on PCD
PCS1.C8	Flash 2 MBit Flash 4 MBit		240 kByte 2) 1008 kByte	128 kByte 896 kByte	No carriers No carriers
PCD1. M110 /120/150	Empty space 1 RAM 256 kBit 1 RAM 1MBit 1 Flash 1MBit 1 EPROM 512kBit 1 EPROM 1Mbit	4 502 5414 0 4 502 7013 0 4 502 7141 0 4 502 3958 0 4 502 7126 0	17 kByte 32 kByte 128 kByte 112 kByte 64 kByte 128 kByte	None 13 kByte 13 kByte 13 kByte 13 kByte	R R R E E E
PCD2.M110 /120/150	Empty space 1 RAM 256 kBit 1 RAM 1 Mbit 1 RAM 4 MBits 1 Flash 1 MBit 1 Flash 4 MBit 1 EPROM 512 kBit 1 EPROM 1 MBit 1 EPROM 4 MBit	4 502 5414 0 4 502 7013 0 4 502 7175 0 4 502 7141 0 4 502 7224 0 4 502 3958 0 4 502 7126 0 4 502 7223 0	32/128 kByte ¹⁾ 32 kByte 128 kByte 512 kByte 112 kByte 448 kByte 64 kByte 128 kByte 512 kByte	None 24/128 kByte ¹⁾ 24/128 kByte¹⁾ 24/128 kByte ¹⁾ 24/128 kByte ¹⁾ 24/128 kByte ¹⁾ 24/128 kByte ¹⁾ 24/128 kByte ¹⁾ 24/128 kByte ¹⁾	R , <=1Mbit R , <=1Mbit R , <=1Mbit R , >1Mbit F , <=1Mbit F , >1Mbit E , <=1Mbit E , <=1Mbit E , >1Mbit
PCD4.M	2 RAM 62256 2 RAM 1 Mbit 2 EPROM 256 kBit 2 EPROM 512 kBit 2 EPROM 1 MBit	4 502 5414 0 4 502 7013 0 4 502 5327 0 4 502 3958 0 4 502 7126 0	64 kByte 256 kByte 64 kByte 128 kByte 256 kByte	172 kByte, for memory PCD7.R310	RAM RAM E256 E512 E1M

¹⁾ 128 kByte for all PCD2.M110/120 with hardware versions J or higher, 128 kByte for all PCD2.M150

²⁾ 1008 kByte for all PCS1 hardware version bigger or equal to E

Jumpers: R= RAM, E = EPROM, F = Flash

If the PCD's memory size is unknown, find the reference printed on the memory chip itself and use the table below to determine the stock number and memory size:

Memory Size	Order Number	Reference
RAM 256 kBit	4 502 5414 0	SRM 2B256SLCX70 HY62256ALP-70 GM76C256CLL-70 M5M5256DP-70LL TC55257DPL-70L
RAM 1 MBit	4 502 7013 0	BS62LV1025 PC-70 LP621024D-70LL SRM20100LLC70 HY628100ALP-70 GM76C8128CLL-70 M5M51008BP-70L TC551001BLP-70L
RAM 4 MBit	4 502 7175 0	BS62LV4006PC P55 BS62LV4007PC P55 HM628512LP-5 KM684000ALP-5L KM684000BLP-5L
Flash 1 MBit	4 502 7141 0	AM29F010-70PC
Flash 4 MBit	4 502 7224 0	AM29F040 auf Sockel
EPROM 256 kBit	4 502 5327 0	UPD27C256AD-10 M27C256B-10F1 TMS27C256-10JL
EPROM 512 kBit	4 502 3958 0	AM27C512-15XF1 AMC27C512-15XF1 AM27C512-90DC UPD27C512D-10 M27512-10XF1 M27512-10F1
EPROM 1 MBit	4 502 7126 0	AM27C010-90DC NM27C010Q-90 M27C1001-10F1
EPROM 4 MBit	4 502 7223 0	AM27C040-100DC M27C4001-10F1

PCD Type	Code/Text/ Extension Memory Size (RAM)	Internal memory backup (Flash)	External memory backup (Flash)
PCD4.M170 PCD2.M170 PCD2.M480	1024 kByte	Aucune	PCD7.R400 - 1024 kByte
PCD3.M3020P CD3.M3120	128 kByte	128 kByte	PCD3.R500 - 128 kByte
PCD3.M3230 PCD3.M3330	256 kByte	256 kByte	PCD3.R500 - 256 kByte
PCD3.M5440 PCD3.M5540 PCD3.M6340 PCD3.M6540	512 kByte	256 kByte	PCD7.R500 - 512 kByte

New PCD systems support internal or external backup memory: PCD7.R400/R500 (optional).

Backup memory lets you save a RAM copy (code/text/extension) of the application program to flash memory, where none of the contents will be lost on a power cut or faulty battery.

We recommend that you use the backup memory on your PCDs to protect yourselves against any undesirable loss of data.

If the RAM application program (code/text/extension) is corrupted, a PCD coldstart will automatically restore the program from backup memory.



PCD7.R400

PCD7.R500

External backup memory also lets you transfer applications from one PLC to another, and create a RAM store of texts and DBs in extension memory while the PLC is running (address ≥ 4000).

Note:

Regardless of any storage in backup memory, you must still backup the project's source files. The source files are not stored in the PCD's memory.

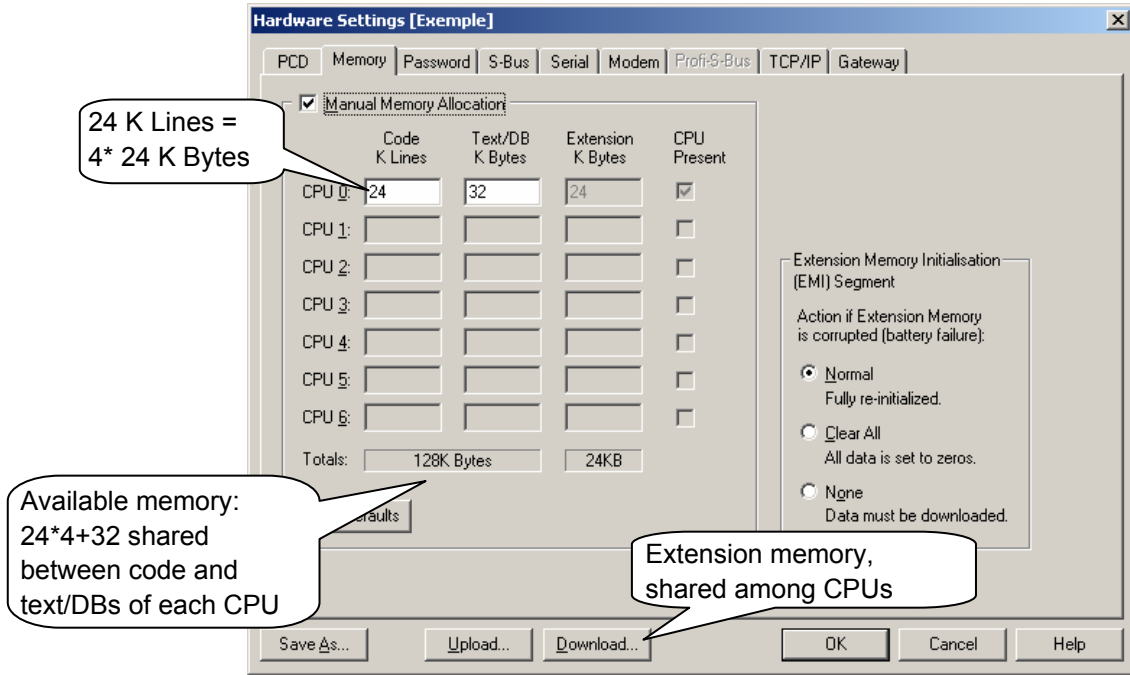

Available memory defined on the PCD page is shared between the program's code and text in each CPU. Some PCDs have more than one CPU: PCD4.M44x and PCD6.Mxxx.

For a single CPU, this is defined automatically according to the user program, so *Manual Memory Allocation* can remain unchecked.

Default parameters are adequate for most applications. In applications where they are not, an error message like this will appear when downloading the program to the PCD:

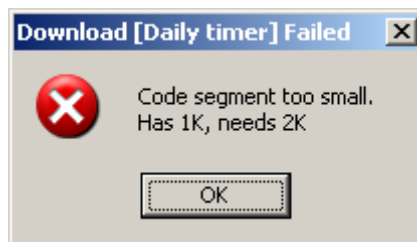

There are several ways around this error:

- Uncheck *Manual Memory Allocation* and let the PG5 do the code/text partitioning, if there's enough memory.
- Check *Manual Memory Allocation* and configure the memory allocation according to the error message.
- Increase PCD memory capacity.



When the *Hardware Settings* have been defined, always remember to download them into the PCD by pressing the *Download* button, or using the *Online, Hardware Settings, Download* menu command.

2.3.7 Software Settings

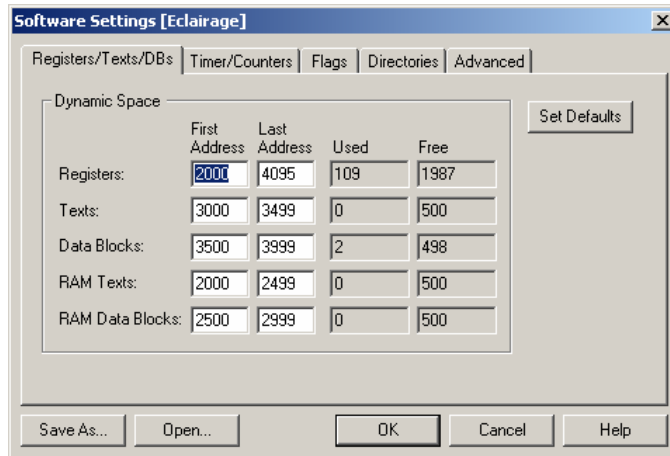

This window allows the user to reserve address ranges for registers, counters, timers and dynamic flags. During the program build, these addresses are automatically assigned to dynamic symbols defined by the user program and Fupla FBoxes.

A dynamic symbol is one for which no absolute address has been defined:

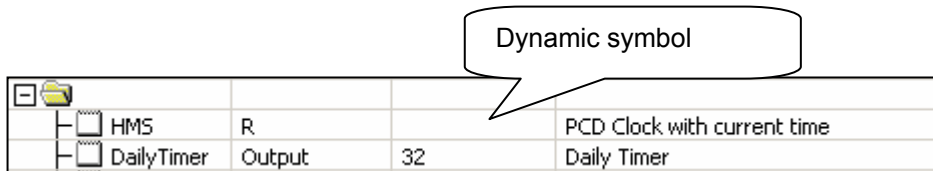

It is not always necessary to change the dynamic addresses. The default settings are usually adequate for most applications.

However, if an error message like this appears during the build of a large program:

Fatal Error 368: Auto-allocation/dynamic space overflow for type: R

then it will be necessary to extend the dynamic address range for the media type shown in the error message.

If the controller is equipped with EPROM or Flash memory, the *RAM Texts* and *RAM View Block* dynamic ranges will also have to be configured to addresses from 4000 upwards, so that these Texts and DBs will be in writeable RAM memory.

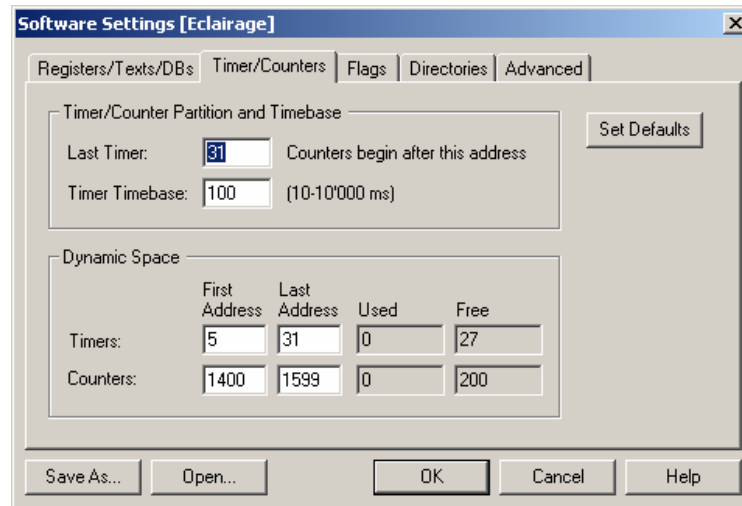

PCDs are configured with 31 timers, some of which have their addresses assigned dynamically. With certain programs it may be necessary to increase the number of timers.

The timebase at which timers decrement is once every 0.1 seconds (100ms). If necessary this can be set to another value. Note that the timebase has no influence on Fupla programs. Only IL programs are affected by this parameter.

It is advisable not to define an unnecessarily large number of timers, nor an unnecessarily small timebase. This will help speed up program cycle times.

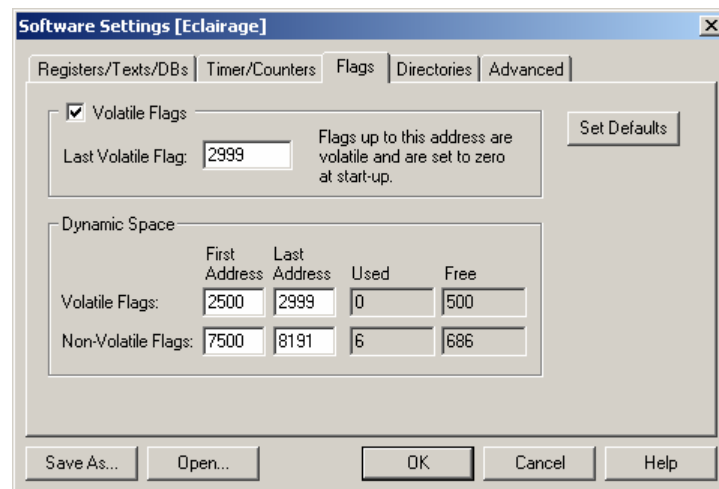

By default, all flags are nonvolatile. If necessary, the *Last Volatile Flag* parameter allows a volatile range to be defined. (This example defines volatile flags for addresses F 0 to F 2999.) Volatile flags are always set to 0 at start-up, nonvolatile flags retain their values.

2.3.8 Program Files folder

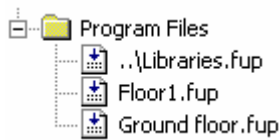

This folder holds the files that make up the CPU's program. To modify files in a program folder, right-click on the folder or file to show the context menu.

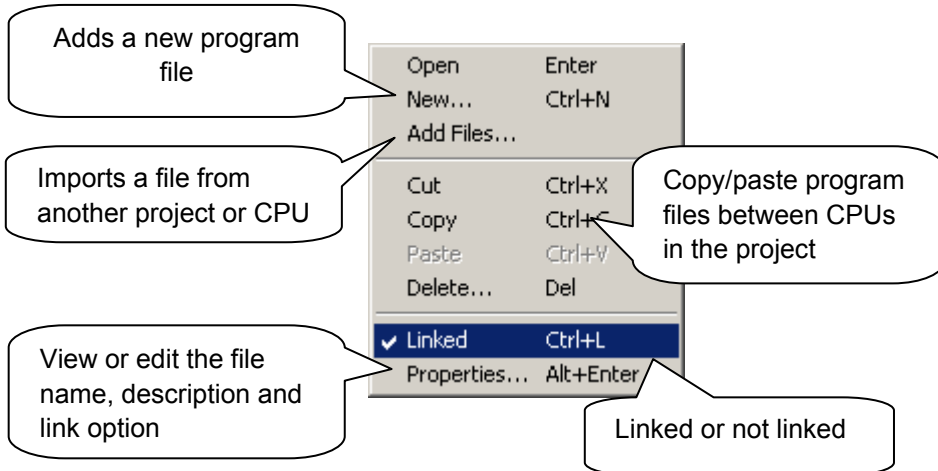

If a new file is added to the program folder, define the file name and type.

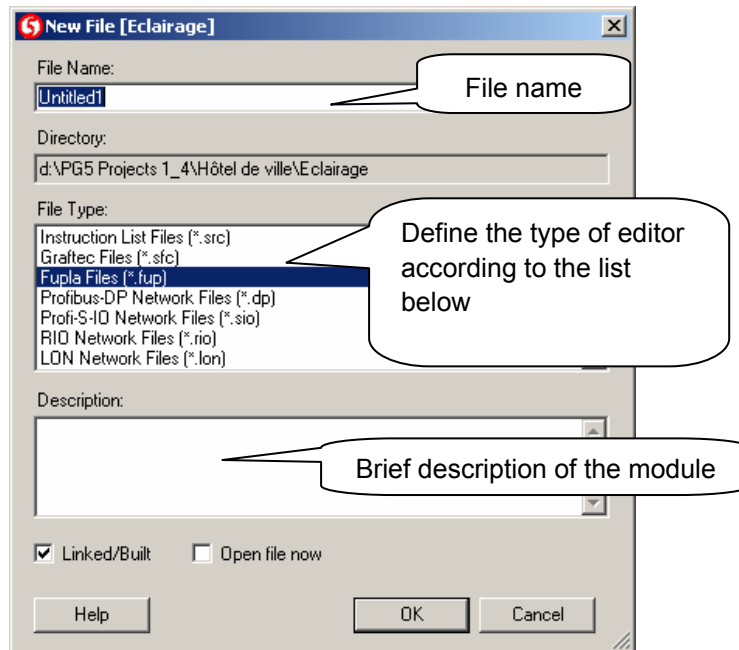

2.3.9 File types

A CPU can have several program files of different types. Each type of file has a corresponding editor specific to a field of application.

Instruction list editor (*.src)

Allows programming in text form with a set of 127 instructions. Suitable for all applications, but requires a certain amount of programming experience.

```

COB  0
      0
STH  I 0
DYN  F 9
INC  C 53
ECOB
    
```

Fupla editor (*.fup)

Allows programs to be drawn in the form of function plans and contact diagrams. Requires no programming experience. Many libraries are available for the rapid implementation of HEAVAC applications and communications networks (modem, Lon, Belimo, EIB, etc.).

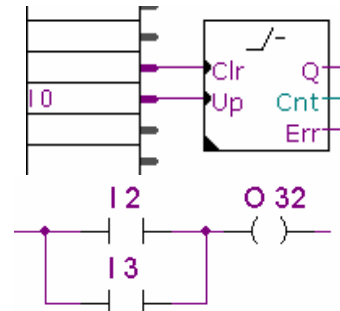

Graftec editor (*.sfc)

This is a tool for structuring programs in IL (instruction list) and Fupla. Particularly suitable for sequential applications with waits for internal or external events. It is the ideal tool for programming machines with commands for motors, actuators, etc.

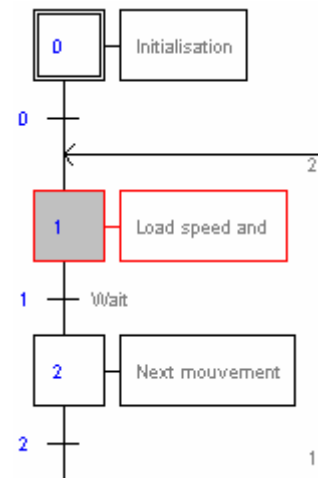

HMI editor

Allows configuration of dialogue with PCD7.D1xx et PCD7.D2xx terminals (installed in addition to PG5)



S-Net editor (*.dp, *.lon, *.rio)

Supports configuration of communications networks: Profibus DP, LON and SRIO.

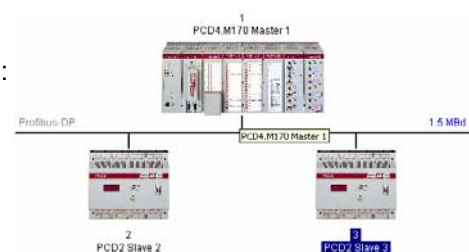

2.3.10 Files linked



Files represented by this icon with an arrow are linked together to form the program, and are downloaded into the PCD's memory.



Files represented by this icon *without* an arrow are not part of the program. They files are ignored and are not downloaded to PCD memory. This can be useful for modules which are linked for commissioning tests, but which should not be present in the final program.

2.3.11 Common files

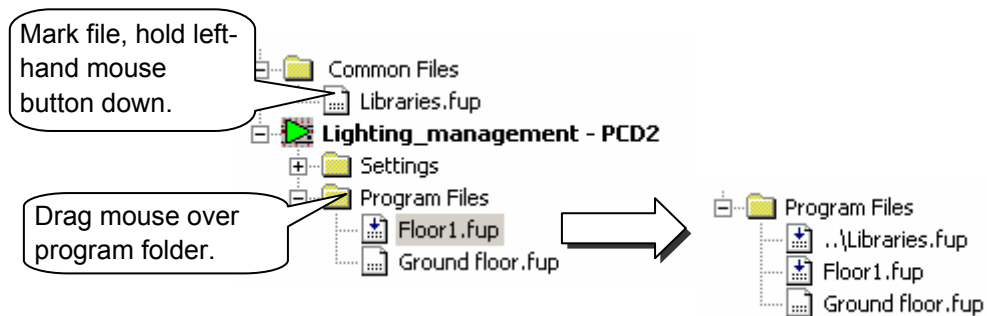

Files in the *Common Files* folder can be copied, pasted or just dragged into the program folder of the CPU that uses them. Note the two dots at the start of the copied or dragged file name. This path means that the file is in a folder which is one level up.

The file can be edited from the common files folder, or from the program files folder of the CPU. In either case, the user is modifying the same file and corrections will apply for all CPUs linked to it.

2.4 Building the program

The PCD cannot process programs directly after editing in Fupla, IL, Graftec, S-Net or HMI. Files must first be prepared using the different stages set out in this diagram:

Source files :

- Graphical programs

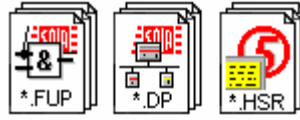

1. Compile

- Instruction list programs



Rebuild all
or
Build

2. Assemble

Object and listing files



Printer

3. Link

PCD file

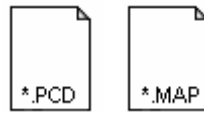

Download
program

4. CPU, Create Doc-
umentation command

PCD controller

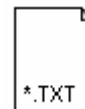

Printer

1. Compilation converts graphical files into instruction list files (*.fbd, *.src, *.hsr)
2. Assembly produces binary object files (*.obj), and an assembly report (*.lst) which can be printed or used for troubleshooting certain assembler errors.
3. Linking combines object files (*.obj) to form a single executable file (*.pcd) for downloading into the controller.
4. Documentation can be generated with the Project Manager's *CPU, Create Documentation* menu command. The result will be available in the *Documentation Files* folder.

2.4.1 **Rebuild All and Build**



*Rebuild
All Files*

Le button, menu *CPU, Rebuild all Files*, starts the compilation, assembly and linkage of all files linked for the active CPU.



*Build
Changed
Files*

The button, menu *CPU, Build Changed Files* does the same job, but only for files which have been modified since *Build Changed Files* or *Rebuild All Files*. This saves time when building large programs.

2.4.2 **Build options**

More can be done by setting the build options with the menu command *Tools, Options*:

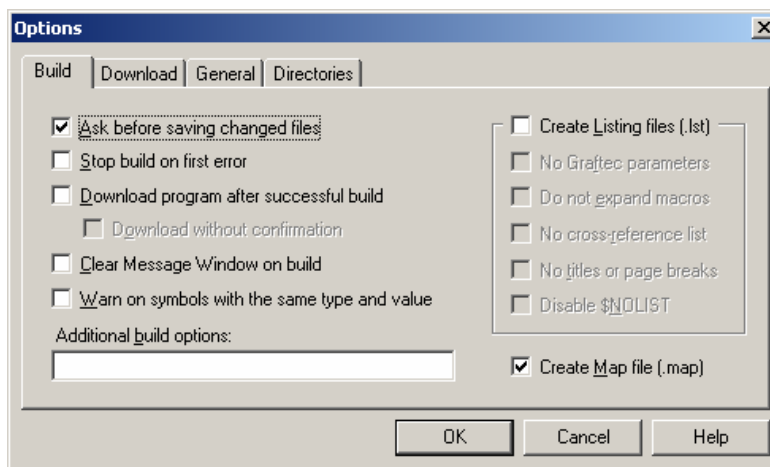

Ask before saving changed files before a build

If selected, the PG5 requests authorization to save source files which have been changed but not saved before building the program. Otherwise files will be saved automatically.

Stop build on first error

Selecting this option will stop the build when the first error appears in the Messages window.

Download program after successful build

Selecting this option automatically downloads the program to the PCD, but only if the build ends with no errors.

Download without confirmation

Normally the process of downloading the program to PCD memory starts with a dialog box notifying the user and to be acknowledged with an OK button. Selecting this option downloads the program directly, without displaying the dialog box.

Clear Message Window on build

The Messages window will be cleared at the start of each build.

Create listing file

Creates an assembly report (*.lst)

Create map file

Creates a file showing with the memory space taken up by the application and a list of the global symbols.

2.5 Messages window

The Messages window provides information on the progress of a program build. It notes the different stages of the build: compilation, assembly and linkage. If the program has been edited correctly, the build ends with the message: *Build successful. Total errors 0 Total warnings: 0*

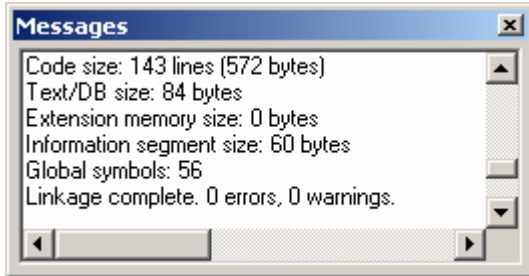

Any errors will be indicated with a message in red. Double-clicking with the mouse on these messages generally enables the error to be located in the application program.

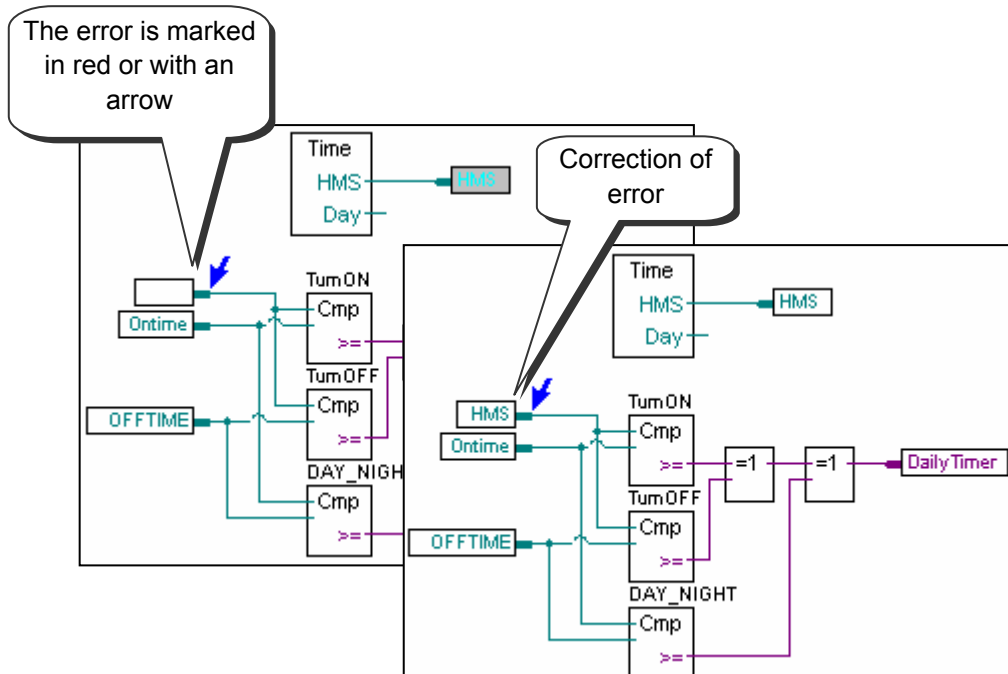
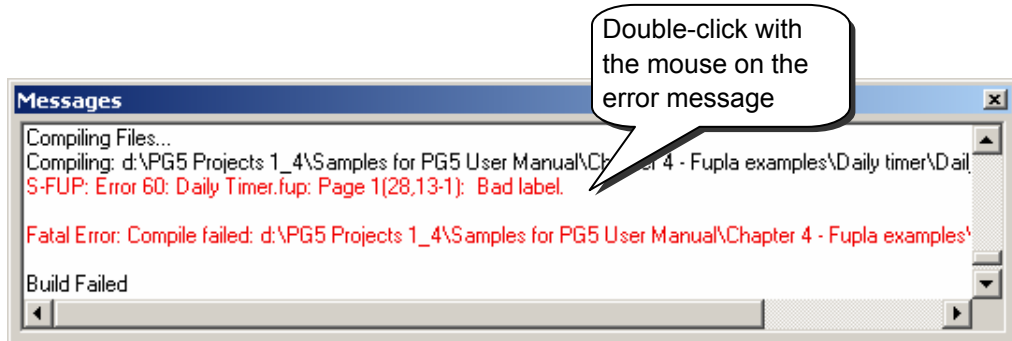

2.6 Downloading the program into the PCD



Download Program

If the build concludes without any error messages, the *Download Program* button or the *Online, Download Program* menu command can be used to load the program into the PCD's memory.

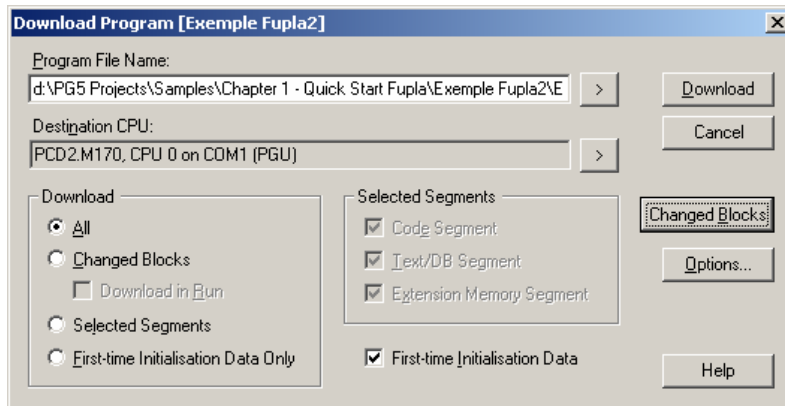

Program File Name

By default this is the name of the program for the active CPU.

All

Downloads the entire program (Code Segment, Text/DB Segment, Extension Memory Segment)

Changed Blocks

Only downloads blocks (COB,PB,FB,SB,ST,TR,XOB) modified since the last Download. This option is only used to save time with minor program corrections. The Changed Blocks button can be used to display a list of changed blocks.

Download in Run

Allows changed program blocks to be downloaded without halting program execution. Proper operation of this option may depend on the corrections being made to the program.

Selected Segments

Only downloads segments defined under Selected Segments:
 Code Segment = Program, Text/DB Segment = Text and DB 0...3999, Extension Memory Segment = Text and DB 4000...7999.

First-time Initialisation Data Only

Only downloads the Data described below.

First-time Initialisation Data

This option authorizes the initialisation of certain Datas during a program build. Datas initialised by the program download are defined as follows:

symbol type address := initialisation_value

Group/Symbol	Type	Address/Value	Comment
Symbol0	R	10:= 314	First time initialisation value = 314
Symbol1	R	11	

Datas not initialised with the program download can be initialised at every coldstart by code in XOB16.

2.6.1 Download options

Download options can be defined with the *Tools, Options* menu command, or the *Options* button on the *Download Program* dialog box. They allow the program download procedure to be personalized.

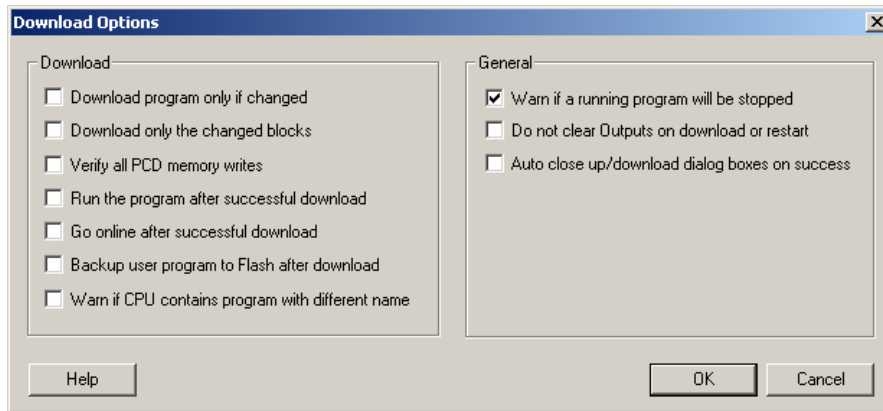

Download program only if changed

These define the default settings for the Download Program dialog box, see previous page.

Download only the changed Blocks

See previous page.

Verify all PCD memory writes

All View written to the PCD will be read back and compared. This option should not normally be selected, because it doubles the program download time.

Run the program after successful download

Automatically puts the CPU into Run after a program download. Caution: this option should only be selected if the program is working correctly and there is no possible risk to people or property if it fails.

Go online after successful download

Automatically puts the CPU online after the download.

Backup user program to Flash after download

Automatically copies the program to Flash¹ memory backup.

If this option has not been selected, a copy can still be made after the download, by using the *Online* menu: *Flash Backup/Restore*.

Warn if CPU contains program with different name

Compares the program name still present in the PCD with the name of the program being changed. If these program names differ, a message will be displayed to prevent downloading to the wrong CPU.

Warn if a running program will be stopped

Downloading a program can stop the PCD. Selecting this option allows a warning message to be displayed before the PCD is stopped.

Do not clear Outputs on download or restart

This option can be useful with HEAVAC applications. It prevents ventilation or lighting from being switched off while a program is being downloaded. It should not be selected with other applications.

Auto close Up/Download dialog boxes on success

If this option is selected, the *Up/Download* dialog boxes will only remain on view if there was an error.

1) PCD2.M170, PCD2.M480, PCD4.M170 et PCD3

2.6.2 Load program onto backup memory (Flash card)

If your PCD is equipped with Flash¹ memory backup, the *Online, Flash Backup/Restore* menu command allows a program loaded in the PCD's RAM memory to be copied to the flash card, and vice versa. This can be supported automatically by selecting the appropriate download option.

2.6.3 Backup memory and transfer of the application program

Backup memory can be used to transfer an application program from one PCD to another of the same type:

- Load the program onto backup memory.
- Cut supply to the PCD before removing backup memory.
- Disconnect power to PCD before plugging in backup memory.
- Remove the battery, or press the backup memory button for 3 seconds (PCD7.R400 only)
- Reconnect power to PCD. The LEDs will flash while the application program is restored from backup memory.
- Insert the battery module to avoid a *battery fail* error message.

2.7 View window

Information displayed by this window is only available if the program build ends successfully.

2.7.1 Organization block structure

The SAIA PCD program is a structure of different organization blocks in which the user stores programs for the application.

Each block offers a particular service: cyclical programming (COB), sequential programming (SB) sub-programs (PB), functions with parameters (FB), exception routines (XOB).

After building the program, the *Block Structure view* button, or the *View block Structure* menu command, can be used to view the overall structure of the organization blocks that make up the program.

The example below shows a program made up of blocks: COB 0, COB 1, XOB16 PB 10, PB11 and FB 156.

Note that COB 0 conditionally calls three sub-blocks (PB 10, 11 and FB 156). The call condition is indicated in brackets.

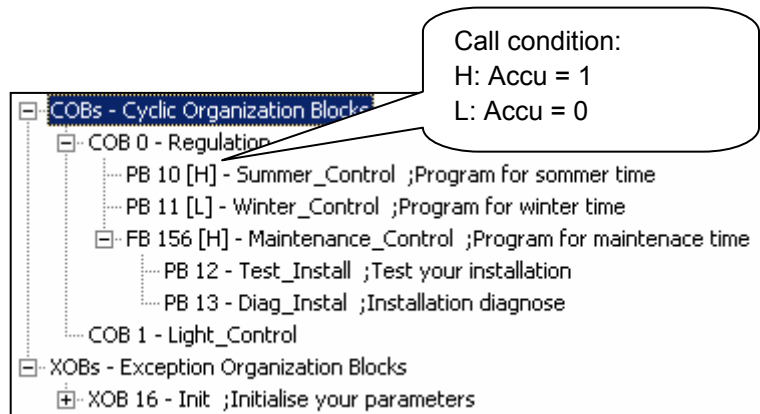

2.7.2 List of organization blocks

The *Block List* view button, or the *Block List* menu command, displays the list of all blocks making up the program.



*Block
List
view*

Block Name	Type	Address	Comment
Regulation	COB	0	
Summer_Control	PB	10	Program for sommer time
Winter_Control	PB	11	Program for winter time
Maintenance_Control	FB	156	Program for mainten...
Light_Control	COB	1	
Init	XOB	16	Initialise your parameters
Test_Install	PB	12	Test your installation
Diag_Instal	PB	13	Installation diagnose

2.7.3 List of symbols

Menu commands *View, Global Symbols* and *View, View List* display the symbols used by the program:



*Global
Symbols*

- *Global Symbols* displays the *Symbol Editor* which defines the symbols shared by all files of the active CPU. These symbols can be edited here.
- *View List* view displays all the symbols used by the active CPU. This list is not editable. Symbols which are never used are not shown in this view.



*View
List view*

Symbol	Type	Address/...	Scope	Module	Comment
DailyTimer	O	32		Daily Timer.fbd	Daily Timer
HMS	R	2003	AUTO	Daily Timer.fbd	PCD Clock with current time
OFFTIME	R	2004	AUTO	Daily Timer.fbd	Switch off time
ONTIME	R	2005	AUTO	Daily Timer.fbd	Switch on time

2.7.4 Cross-Reference

The *Global Symbols* and *View List* views offer the possibility of selecting a symbol and showing its cross-reference list, i.e. a list of all program locations where the symbol is used.

Each entry shows the file name and block in which the symbol selected is used, with a line or page number too. It also shows if the could be changed at that location with the word *Written*.

The *Definitions* list shows where the symbol is defined, e.g. where its IL EQU statement can be found. The *References* list shows where the symbol is used in the program.

For blocks, '>>' indicates where the block itself can be found.

To view the program where the symbol is used, select the definition or reference and press the *Goto* button.

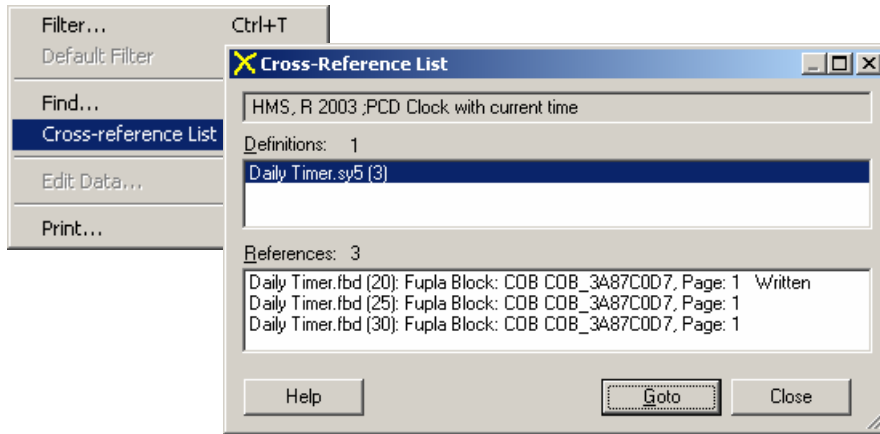

2.8 Program backup

The result of any PCD program modification is sometimes uncertain. For example, you may not be sure whether the available source files are the latest version, you may be unfamiliar with the installation, etc.

To avoid any concern this might cause, the entire contents of the PCD's memory can be saved, and restored if there's a problem.

The Online Configurator's *Tools, Upload All* command allows the entire PCD's memory to be saved in a single file (including the program, hardware settings, values of registers, flags, counters, DBs and texts).

To restore the program to the PCD's memory, use the *Tools, Download All* command, and select the file.

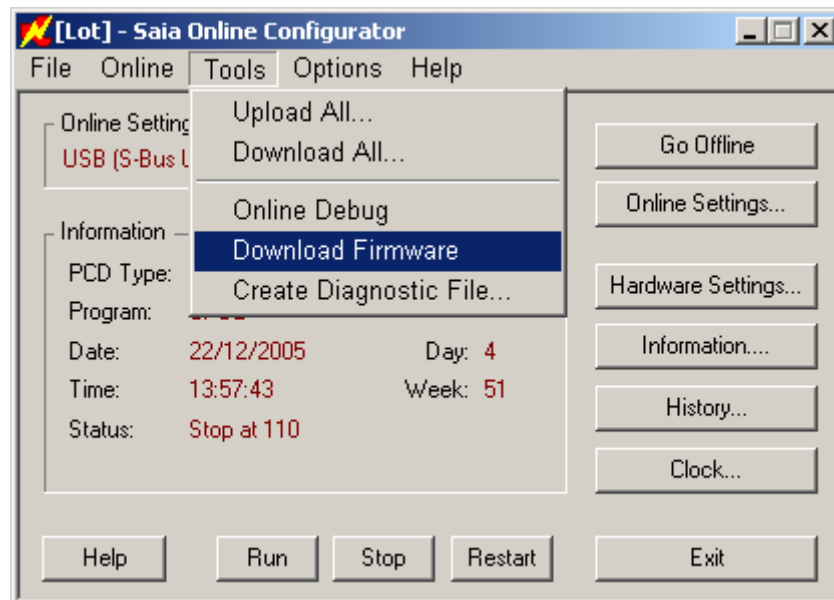

Note:

Backups are also possible with backup memory: PCD7.R400/R500

2.9 Self downloading files

The self-downloading files feature makes it much easier to download programs and *hardware settings* to PCDs on site.

This PG5 tool allows you to prepare a '.sd5' file containing all the information needed to update PCD programs and configurations. The PG5 programmer then simply sends this file by e-mail to the person in charge at the PCD job site.

When you open a '.sd5' file, the dialog box for downloading data is displayed. Certain parameters and options on it will match predefined ones in the PG5 project. The person present at the job site can either leave these options as they are, or modify them before downloading to the PCD.

This means that no special knowledge of PG5 use is needed to download programs or PCD *hardware settings*. The tool allows programs and *hardware settings* to be downloaded without having to install either PG5 or user licence. However, the *Stand Alone Online Tools* package must still be installed at the job site.

2.9.1 Prepare a '.sd5' file

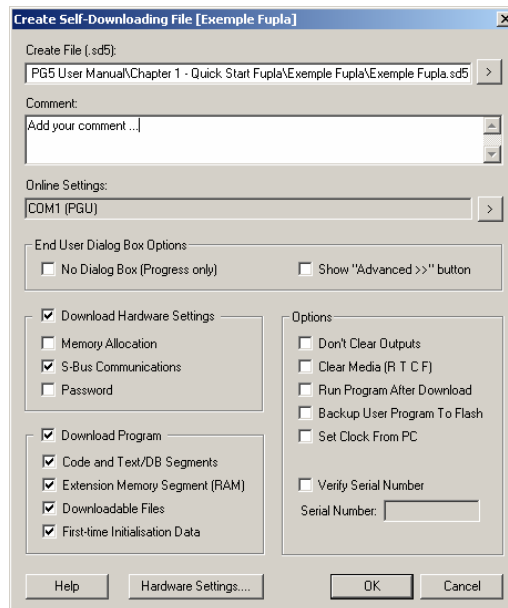

The file is prepared from information contained in the active CPU, as shown by the *Project Tree* window. It is advisable to check that *Online Settings* and *Hardware Settings* are correctly configured and to perform a CPU *build* before preparing the '.sd5' file.

The CPU menu: *Create Self-Downloading File* allows you to configure parameters and options for self downloading at the job site.

These parameters and options are the same as those we already know from other menus: *Online*, *Hardware Settings*, *Download* and *Online, Download Program ...*. However, a few new parameters have been added:

Create Files (*.sd5)

Lets you define the .sd5 path and filename.

Show “ Advanced >>” button

Lets you hide all preselections in this dialog box during self-downloading

No Dialog box (Progress only)

Downloads the '.sd5' file without displaying a dialog box (silent mode)

Verify Serial Number

Self-downloading checks that the PCD's serial number matches the one defined in the *Serial Number* field. This serial number is unique to each PCD and can therefore be used to ensure that the download goes to the intended PCD.

Note:

The serial number is only supported by new PCD3 systems. The *Online Configurator* can be used to read it online, using the menu *Online, Information*.

2.9.2 Downloading a '.sd5' file

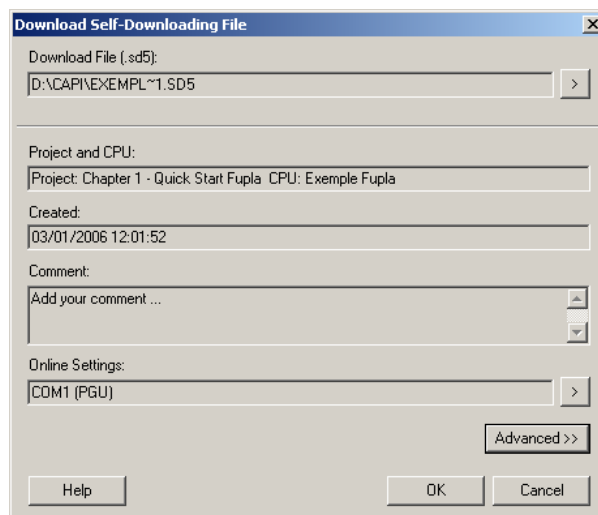

To download contents from an '.sd5' file, check that PG5 or *Stand Alone Online Tools* have been installed on the PC. For more details, please refer to the PG5 installation guide.

Open the '.sd5' file from *Windows Explorer* by double-clicking with the mouse. A dialog box like the one above should be displayed.

You can reconfigure the downloading of file contents via the *Advanced* button. Start the *download* with the OK button.

Contents

3	PCD - RESOURCES	3
3.1	Introduction	3
3.2	Hardware resources	4
3.2.1	Digital inputs and outputs	4
3.2.2	Time	5
3.2.3	Interrupt inputs	6
3.3	Internal resources (softwares)	7
3.3.1	Flags	7
3.3.2	Registers	8
3.3.3	Constants	9
3.3.4	Timers and counters	10
3.3.5	Text and data blocks	13
3.3.1	Summary table	15
3.4	Symbol editor	16
3.4.1	Elements of a resource	16
3.4.2	Grouping symbols together	17
3.4.3	Scope of symbols	17
3.4.4	Local symbols	18
3.4.5	Global symbols	18
3.4.6	Define a global symbol	19
3.4.7	Define symbols for the communications networks	19
3.5	Working with symbols	20
3.5.1	Writing a symbol list	20
3.5.2	Adding several symbols to the symbol editor	21
3.5.3	Referenced symbols	22
3.5.4	Importing symbols from "EQUATE" statements	23
3.5.5	Importing symbols from another application	23
3.5.6	Adding a symbol while typing your program IL	23
3.5.7	Adding a symbol while typing your program in Fupla	24
3.5.8	Transferring symbols	25
3.5.9	Auto complete symbols	26
3.5.10	Auto allocation	26
3.5.11	Entering text	27
3.5.12	Entering DBs	28
3.5.13	Search for a symbol	28
3.5.14	Arranging your symbols	29
3.5.15	Rearrange in "List View"	30
3.5.16	Exporting symbols	31
3.5.17	Importing symbols	33
3.5.18	Initialization of symbols	35
3.5.19	Symbol names	36
3.5.20	Reserved words	36

3 PCD - Resources

3.1 Introduction

This chapter provides an overview of the data types that may be used when writing an application.

The first two sections summarize all the familiar SAIA®PCD elements, such as inputs, outputs and flags, with their address ranges and usage.

The second two sections show how to use these elements in the symbol editor.

3.2 Hardware resources

Each program is made up of functions that allow the user to read, write, and manipulate different kinds of resources. Those resources which allow us to interact with our environment are called hardware resources.

3.2.1 Digital inputs and outputs

I/O 1 bit of information (0/1)

	max. number of I/Os
PCD1	32 (64 ³⁾)
PCD2.M120/M150	64/96/128 (255 ³⁾) ¹⁾
PCD2.M170 + PCD3.C100	510 ^{2) 3)}
PCD2.M480 + PCD3.C100	1023 ^{1) 3)}
PCD3.Mxxxx	1023 ^{1) 3)}
PCD4	510 ²⁾
PCD6	5100 ²⁾

- 1) The addresses 255 (and 511 for PCD2.M170) are reserved for the watchdog
- 2) The addresses 255, 511, 767, 1023, ... , until 5119) are reserved for the watchdog
- 3) with inputs cards PCD2/3.E16x and/or outputs cards PCD2/3.A46x

Inputs and outputs represent signals to or from the PCD. Inputs show the state of end-switches, pushbuttons, proximity detectors, sensors, etc. Outputs can be used to activate valves, lamps, A/C motors, etc.

You can read and write outputs. Inputs can only be read. Inputs and outputs are added to the PCD by placing I/O cards into one of the designated slots on the PCD. The start address of a slot is defined either by its position (PCD1/2/3 and 4) or by switches (PCD 6).

The following example turns on output O 64 if inputs I1 and I2 are both high. Another way to show such functions is by using boolean equations: $O\ 64 = I\ 1 * I\ 2$

Instruction list program:

```

COB  0
      0
STH  I 1
ANH  I 2
OUT  O 64
ECOB
    
```

Fupla program:

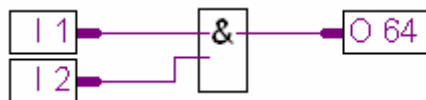

Fbox: Binary, And

3.2.2 Time

A real-time clock (RTC) is built into most PCDs (PCD1.M120/130 and all PCD2/3/4/6). A special instruction is used to load the date and time into a register.

The following example shows how to read the time in a program.

Instruction list program:

```
COB 0
      0
RTIME R 1
ECOB
```

Fupla program:

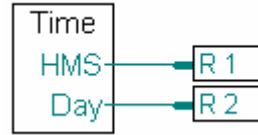

Fbox: *Time Related, Read time*

This program reads the time from the clock and copies the value into register R1. Time is represented in the following way:

```
R 1 = 093510    09 o'clock 35 minutes and 10 seconds
R 2 = 073030210 week 07, day 3 (Wednesday), the 10th of Feb 03 (2003)
```

3.2.3 Interrupt inputs

Some PCDs¹ have two inputs called INB1 and INB2². Whenever there is a rising edge on one of these inputs, the normal program cycle will be interrupted and the PCD will execute a special program block called XOB20 or XOB25 (XOB20 for INB1 and XOB25 for INB2). These inputs are capable of a frequency up to 1000 times per second.

The example demonstrates how to count pulses from INB1.

Instruction list program:

```

COB 0 ; Programme
      0 ; principal

ECOB

XOB 20 ; interruption INB1
INC R 2 ; incrémentation
      ; du registre R2

EXOB

      ivi
      1
      2
      0
      /
    
```

Fupla program:

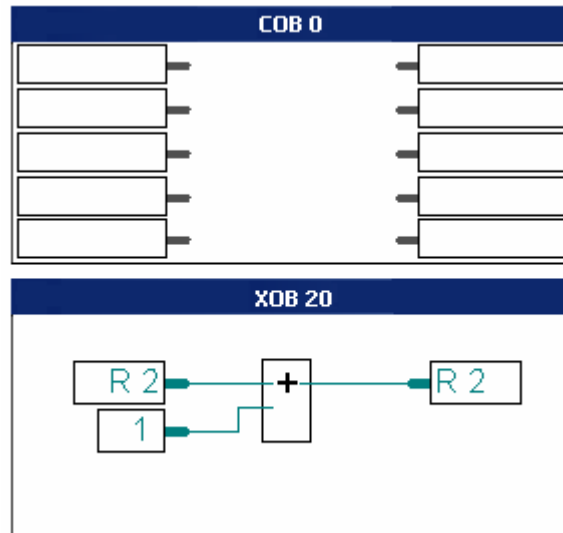

- 1) PCD1.M120/130, PCD2.M120/150, PCD2/4.M170, PCD2.M480 (4 Interrupt inputs IN0 ... IN3) , PCD3.M and PCD6.M3
- 2) For more information see your PCD hardware manuals



Limits imposed by the input filter (protecting a normal digital input against interference and bounce from mechanical contacts) prevent the input from counting pulses with a frequency higher than 50 Hz. Interrupt inputs therefore represent an interesting alternative solution for this kind of application. They bypass the need to use PCD2.H1 or PCD4.H1 counting cards, which have a maximum counting frequency of 10 to 160 kHz, depending on module type.

3.3 Internal resources (softwares)

3.3.1 Flags

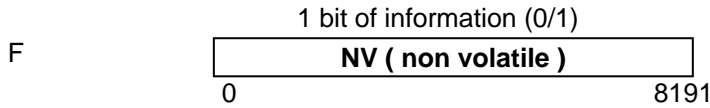

A flag memorizes one bit of information. There are 8192 flags. (F 0 is the first flag). By default, the flags are non-volatile. This means that if you turn off the PCD when the flag is at 1, it will still be at 1 when you turn the PCD back on (assuming your battery is good). Any volatile flags will be reset to 0 if the PCD is turned off. If one or more volatile flags are required, they can be configured in the *Software Settings*. This is explained below.

The following example writes a high (1) to flag number 11 as soon as input 1 or 3 is high. Boolean equation: $F 11 = I 1 + I 3$

How to use flags in your program

Instruction list program:

```

COB  0
      0
STH  I 1
ORH  I 3
OUT  F 11
ECOB
    
```

Fupla program:

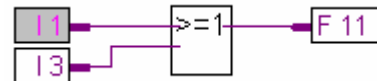

Fbox : Binary, Or

By default, flags are non-volatile. To make them volatile, they must be specified as such in the *Software Settings* (see example).

Setup flags

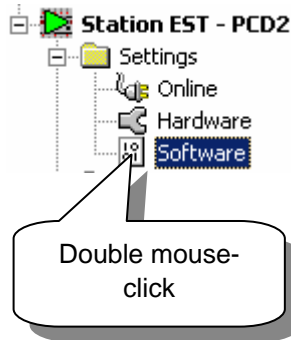

Dynamic Space				
	First Address	Last Address	Used	Free
Volatile Flags:	2500	3000	0	501
Non-Volatile Flags:	7500	8191	2	690

3.3.2 Registers

32 bit value

Integer: -2 147 483 648 to +2 147 483 647

Floating point: -9.22337E+18 to +9.22337E+18

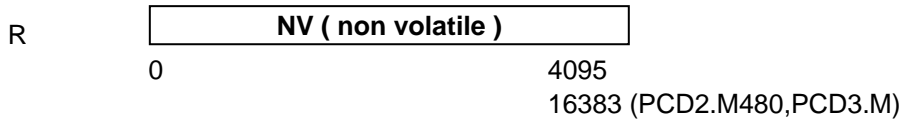

A register can contain floating point or integer values. Registers are extremely useful for arithmetic operations or operations with analogue values, such as measurement and regulation tasks. Up to 4096 registers are available. All registers are non-volatile. In Fupla, the lines connected to a register have different colours depending on content: yellow lines for a floating point value and green lines for an integer value. An integer value cannot interact with a floating point value. For example, they cannot be added together. One of the values must be converted into the format of the other value, and then added.

How to use registers in your program

The following example adds the number 113 to the content of register 12 and puts the result into register 54: $R\ 54 = R\ 12 + 113$

Instruction list program:

```
COB 0
    0
ADD  R 12
    K 113
    R 54
```

Fupla program:

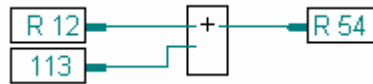

Fbox: *Entier, Addition*

Setup registers

Dynamic resource allocation is a powerful feature introduced to free you from having to specify a fixed address for every resource that you need. Dynamic resources are used by defining a symbol name for a resource without specifying an address. You will not need to change these settings until you start to write large programs with a large number of registers.

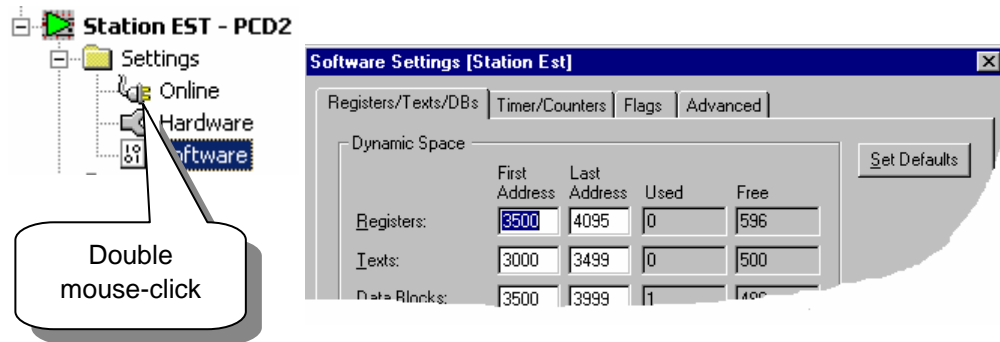

If assembly errors arise (such as *Auto allocation overflow for type: R*) dynamic space settings must be increased.

3.3.3 Constants

32 bit value

Integer: -2 147 483 648 to +2 147 483 647

Floating point: -9.22337E+18 to +9.22337E+18

Constants are fixed values that do not change during the program. They are written into a register.

Example: fixed coefficients, like. π (PI) = 3,1415.

The next example loads register R4 with a fixed value (100). Then register R4 is divided by 0.25. Because register R4 contains an integer value and we want to divide it by a decimal value (0.25), you have to convert R4 to a decimal value. We copy R4 into R35 (a register we are sure is not being used), convert R35 to a decimal value, and then divide R35 by 0.25. The result of the division is placed in R5. R5 is then copied to R6 and R6 is then converted to an integer value.

How to use constants in your program

Instruction list program:

```

COB  0      ;Cyclic organization
      0      ; block
LD   R 4    ;load 100 into R4
      100

COPY  R 4    ;convert the integer
value
      R 35   ;from integer to
IFP   R 35   ;floating point
      0
LD   R 36   ;Load 0,25 into 36.
      2.5e-1
FDIV  R 35   ;divide the value by
      0.25
      R 36
      R 5    ; and place the result
              ;in R5

COPY  R 5    ;convert the result back
to
      R 6    ; integer
FPI   R 6
      0
    
```

Fupla program:

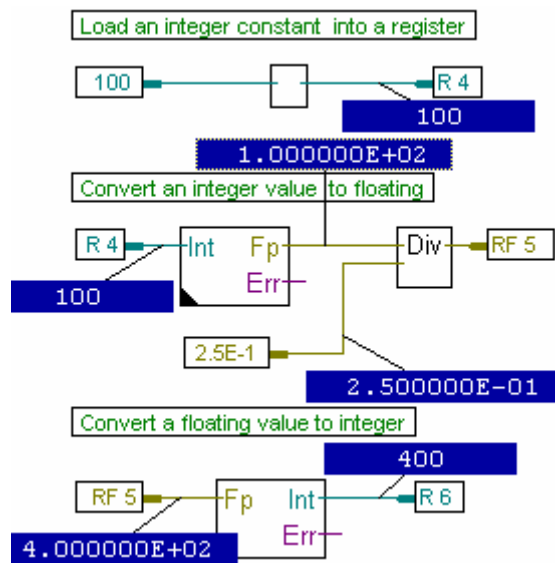

- Fbox: - Integer, Move
- Converter, Int to float
- Floating point, Divide
- Converter, Float to Int

3.3.4 Timers and counters

31 bit value (0 ... 2 147 483 648)

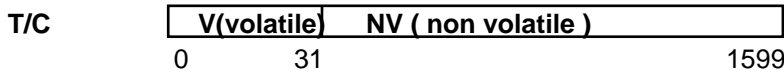

Timers and counters can have values between 0 and 2 147 483 648 (31 bits) and they share the same address range: 0 to 1599. Usually addresses 0 to 31 are dedicated to the timers, and addresses 32 to 1599 are dedicated to the counters.

The user can, of course, configure personal settings. Timers have a default time-base of 100 ms (i.e. the system decrements each timer by one every 100 ms). The timebase can be changed in the *Software Settings*, where timer / counter addresses can also be configured. Timers are volatile, counters are not.

Timers and counters can only contain positive values. Their value can be changed by loading a new value with the LD instruction. Timer values decrease only. Counters can count up or down, using the instruction INC/DEC. (INC: ↑, DEC: ↓).

Timers and counters can also be used with binary instructions. When a timer or counter contains a non-zero value, its state is High (1). When its content is zero, its state is Low (0).

Setup timers/counters

The distribution of the address range between timers and counters can be altered in the *Software Settings*. This is also where you can change the time-base of 100 ms.

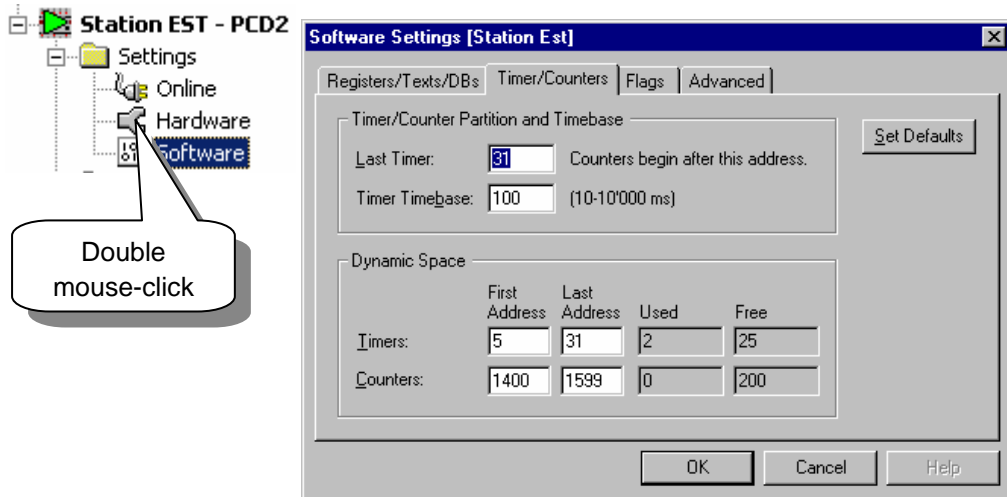

Double mouse-click



Technical information

The more timers you declare, the greater the load on the CPU. This is also true if you lower the time-base. Take this into consideration before you change the number of timers or lower the time-base.

Example: 100 timers will take about 2% of the CPU's capacity.

Example: Timer

There is a high signal at input 4. On the rising edge of this signal, a further high signal will be sent to output 65. This signal will have a duration of 2,5 seconds.

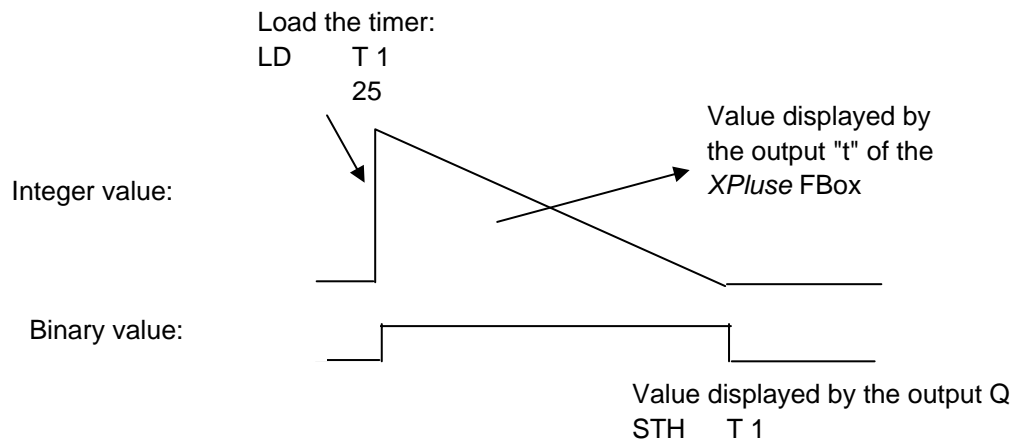

Solution:

Instruction list program:

```

COB  0      ;organization block 0
      0      ; time out time
STH  I 4    ;If input 4
DYN  F 12   ;sees a rising edge
LD   T 1    ; load the timer1
      25    ; with 2,5 seconds
STH  T 1    ;copy timer state
OUT  O 65   ;to the output O65
ECOB
    
```

Fupla program:

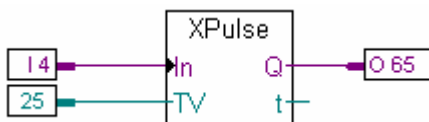

Fbox : *Temporisateurs, Impulsion fixe*



Technical information

Timers in the SAIA PCD are decremented at a rate defined by the Software Settings, Timer, Time-base (normally 100ms). The actual time defined by a constant which is loaded into a timer changes if the time-base is changed. This means that if the time-base setting is changed, then all timer load values must also be changed. To overcome this problem, the time data type can be used to declare timer load values. If a time value is used, then the linker calculates the actual timer load value according to the time-base settings.

Format: T#nnnS|MS

	BL_3DE393BA	COB		
	DelayTime	K Constant	T#100MS	100 millisecondes
	OneDay	K Constant	T#3600S	3600 secondes

Example: Counter

A counter will be programmed to count up each time input 5 receives a signal, and down each time input 6 receives a signal. These counts will be activated on the rising edge of the input signal. The counter can be zeroed with a high at input 2. The initial count will be loaded with 3.

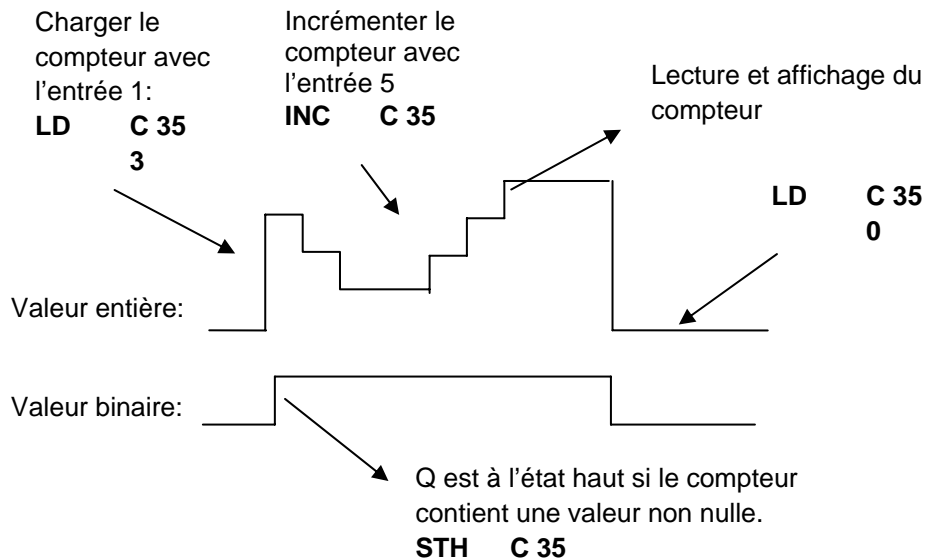

Solution:

Instruction list program:

```

COB 0 ;Cyclic organization block
0 ;
STH I 1 ;If input 1 equals 1
LD C 35 ;then load counter 35
3 ; with 3
STH I 2 ; If input 2 equals 1
LD C 35 ; then load the counter 0
with zero
STH I 5 ;If there is a rising edge
DYN F 13 ;at input 5
INC C 35 ;then increment counter 35
STH I 6 ;If there is a rising edge
DYN F 14 ;at input 6
DEC C 35 ;then decrement the counter
ECOB
    
```

Fupla program:

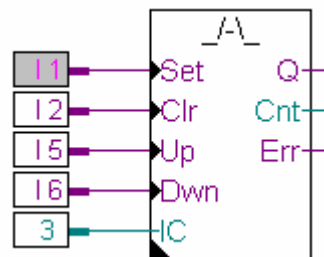

Fbox :
Counter, Up down with preset and clear

3.3.5 Text and data blocks

TEXT/DB	Main memory		NV	
	0			3999
	Extension memory		NV	
	4000		(PCD4/6)	7999
			(PCD2)	5999
			(PCD1)	4999
			(PCD2.M480, PCD3.M)	8191

Text (characters strings) and data blocks (DBs) are non-volatile. Text is used for: messages on displays, text for transmission to a pager, initial strings for modems, etc. DBs are used for data logging, tables etc.



Technical information

Where are saved the text and DB ?

Registers, flags, timers and counters are handled by the system and stored in a small RAM apart from the main memory. DBs and texts on the other hand are stored in the main memory, together with the user program. If you want to use a FLASH Eprom or a normal EPROM for your main memory, remember that when you are in run mode, you can read from this memory but not write to it. Therefore you cannot alter the content of your DBs (for example your data login). In most cases you will not bother with this, but if you know that you are going to read **and write** from your DBs, then make sure to use DBs which are stored in the extension memory => address 4000 and up. (This is the extension memory and it is always RAM, which means you can read and write to it.)

Example: declaration of DBs and text

- TEXT 10 "Bonjour!" ;Text number 10 contains the string Bonjour!
- TEXT 11 [7]"Hello" ;Text number 11 is 7 characters long, of which the last 5 ;are Hello and the first two are spaces.
- DB 12 45,46,78,999,0 ;DB number 12 with the 5 integer values: 45.46,78,999,0
- DB 13 [10] ;DB number 13 is 10 values long and they are zero ;at start-up.
- DB 14 [4] 2,3 ;DB 14 is four values long. The first two are 2 and 3, the second two are 0.

Example: data-logger in Fupla

The following shows how easily values from an analogue card can be logged into DB 4010. Every time the *Store* signal is received, the analogue value is read, and then written to DB 4010.

The screenshot shows the SAIA Fupla Editor interface. A 'DB Logger' block is connected to a 'PCD2.W2' module. The 'DB' input of the logger is set to 'DB 4010'. A callout points to the 'Size of DB' field in the 'Edit Data Block - DB 4010' dialog, which is set to 4 elements. Another callout points to the 'Default values' table in the same dialog, which contains the following data:

Item	Value	Comment
0	0	Default values
1	0	
2	0	
3	0	

A third callout points to the 'Test_DB' symbol in the Symbols list, with the instruction 'Double mouse-click'.

Fboxes:

- Analogue module, PCD2.W2
- Data blocks, DB Logger

Example: sending an SMS in Fupla

The following shows how to send an SMS message using the binary state of a digital input or flag. The message is defined in text 10. Note the black triangles in the lower left-hand corners of the FBoxes in this example. They indicate that these functions have an *adjust window* with parameters for the destination pager or modem number. The adjust windows can be viewed by double-clicking the mouse pointer in the centre of the FBox.

The screenshot shows the SAIA Fupla Editor interface. A 'Modem 14' block is connected to a 'Call SMS' block, which is connected to a 'SEND SMS' block. The 'SEND SMS' block has 'Cal' set to 'Text 10'. A callout points to the 'SEND SMS' block with the instruction 'Double-clicking on the FBox displays the adjust parameters'. Another callout points to the 'Edit Text - Text 10' dialog, which shows the text 'Alarm: battery failure'. A third callout points to the 'Text 10' symbol in the Symbols list, with the instruction 'Double mouse-click'.

Fbox:

- Modem, Modem Driver 14
- Modem SMS, Call SMS
- Modem SMS, Send SMS

3.3.1 Summary table

Description	Media	Operand	Binary	Numeric	Volatile
Inputs	I	1) 0...8191	0,1		
Outputs	O	1) 0...8191	0,1		
Flags	F	0...8191	0,1		2) No
Timers	T	2) 0...31	0,1	0 ... 2 147 483 648	Yes
Counters	C	2) 32...1599	0,1	0 ... 2 147 483 648	No
Registers	R	0...4095 5) 0...16383		-2 147 483 648...+2 147 483 647 -9.22337E+18...+9.22337E+18	No
Text	X	3) 0...3999 4) 4000 ...		String of max. 3072 characters	No
Data blocks	DB	3) 0...3999 4) 4000 ...		Max. 382 values (slow access) Max.16 383 values (fast access)	No

- 1) depending on PLC and its configuration into inputs, outputs
- 2) by default, configurable from *Softwares Settings*
- 3) saved to same memory as programs (RAM / EPROM / FLASH)
- 4) saved to extension memory (RAM)
- 5) PCD2.M480, PCD3.M

3.4 Symbol editor

Before starting to write a program, all the elements to be used in it must first be declared (number of inputs and outputs, number of timers, etc.).

All these elements have to be known by PG5. This is very helpful for finding elements inside program files, reporting programming errors, or for help during the debugging process. All elements to be used are therefore listed in a central tool called the *Symbol Editor*.

The term "symbol" is used rather than "element" to emphasize the fact that each element has a name (symbol). In addition, giving all resources a name makes the program easier to read.

3.4.1 Elements of a resource

Name of resource:
(can be up to 80 characters long)

Type of symbol:
Here you specify what kind of resource you are using. For example Input or Register....

Comment:
Add a long comment to every resource. It makes the program easier to read.

Group	Symbol	Type	Address/Value	Comment
	NormalRun	I	3	Machine is in normal run
	Cond_Run	I	4	Machine is in conditional...
	OilHigh	I	5	Oil Level is too high
	Emergency	I	7	Emergency stop on the ...
	IntermediatFlag	F		
	OilPump	O	20	Oilpump
	OilPumpProg	COB	3	

Filename to which symbols belong.
Symbols are not known to files other than this one.

Global: symbols from this list are known to all CPU files.

Address/Value:
The PG5 must be told which input or output is to be assigned to this symbol. In the case of internal resources (everything but inputs and outputs) it is not necessary to specify an address. The system itself will choose one. This is called auto allocation.

3.4.2 Grouping symbols together

If desired, symbols can be grouped together. This makes the program easier to read. Just use the right mouse button to add a new group to the symbol editor and then drag-and-drop the symbols you want into the folder:

Example: The Group named *LotOne* contains several symbols:

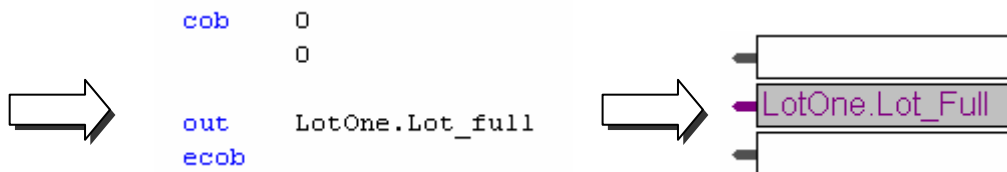
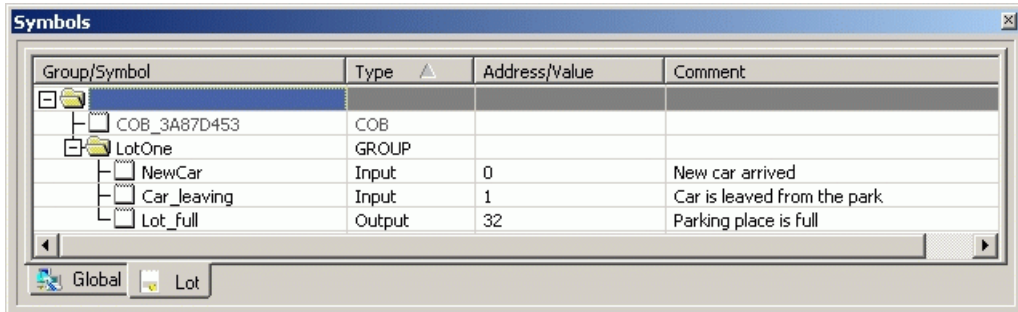

In the program the group name *LotOne* precedes the symbol name *Lot_full* and both are separated by a point.

3.4.3 Scope of symbols

Symbols are normally known to one file only (their scope is local). As soon as a program file is opened in an editor, the symbol editor with the appropriate symbol list will also be opened:

Example:

Opening the program file named *Lot.src* automatically opens the symbol editor with the same name.

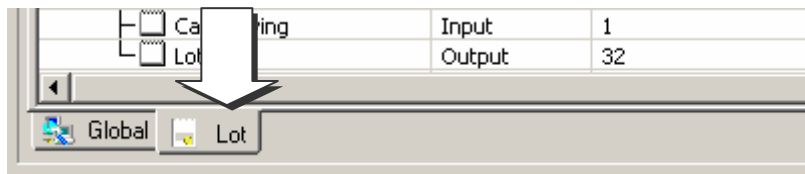

3.4.4 Local symbols

Local symbols are only known to the one file to which they belong.

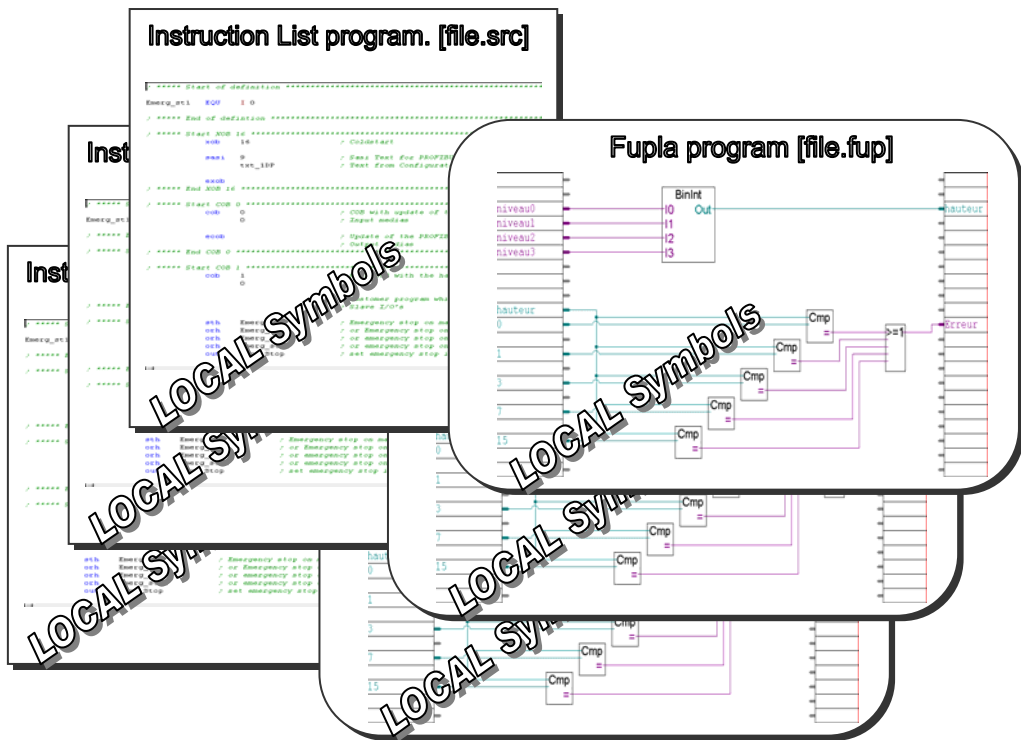

3.4.5 Global symbols

Global symbols are known to all the files in the CPU.

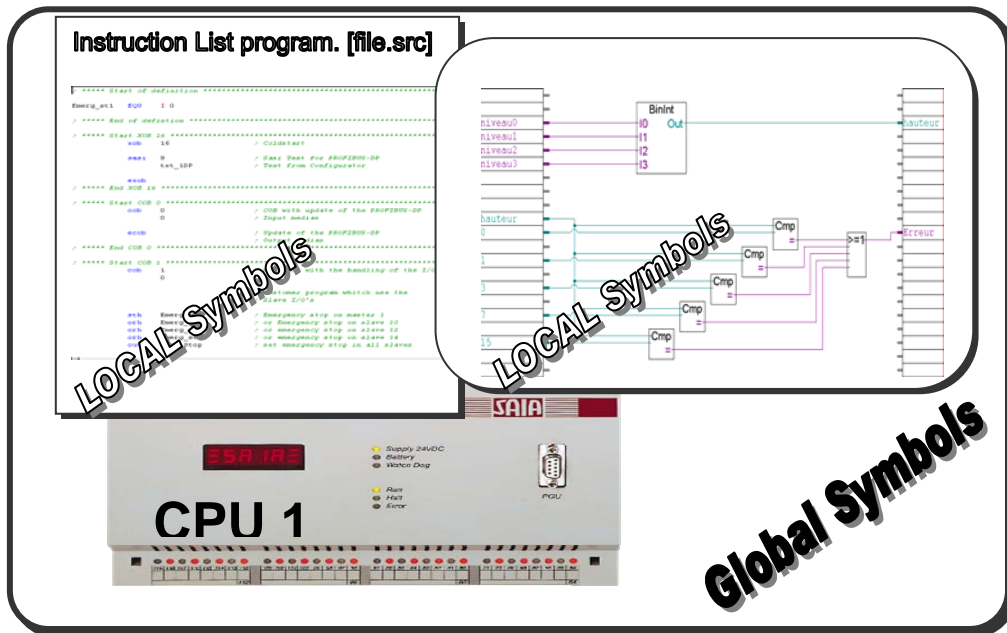

3.4.6 Define a global symbol

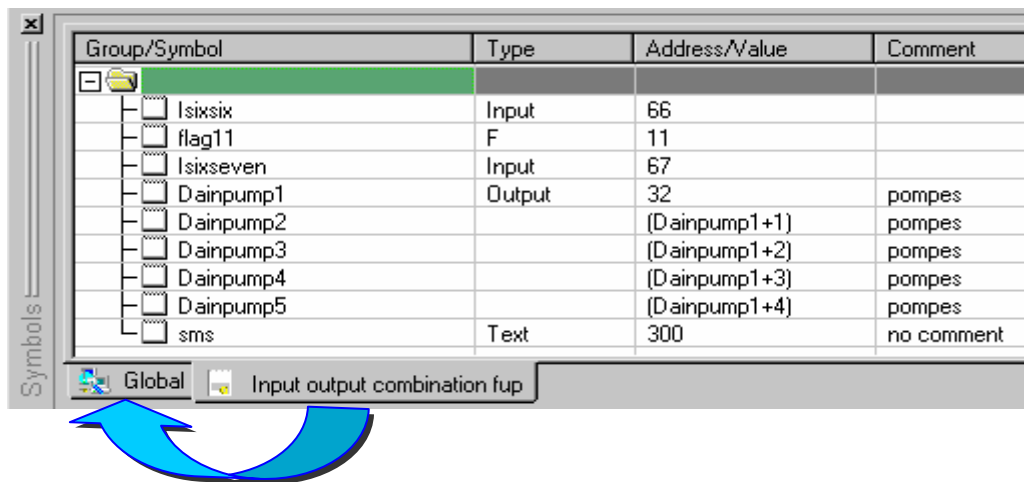

If you want to use the same symbols in several files, then you have to move the symbols from the local list to the *Global* list. Just mark some symbols in the list using the *Advanced, Make Global* function (right mouse click). Once a symbol is listed as *Global* it can be accessed from any file within the project.

3.4.7 Define symbols for the communications networks

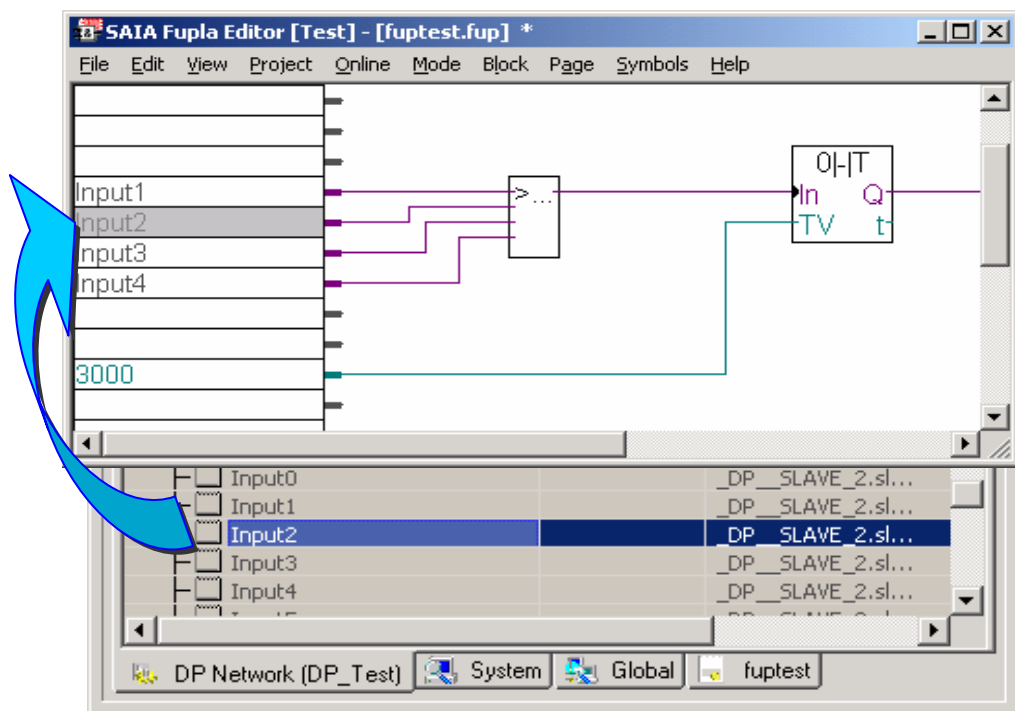

Sharing data between two different PCDs is more complicated than sharing information between files. A type of network connection is required between the two PCDs. This network connection can be designed in our network editor (which to date already supports SBus, Profibus DP, Profibus FMS and LON networks). The network editor lists all the symbols in the “Network” list. Network symbols can be used in a program to move data from one PCD to another.

3.5 Working with symbols

3.5.1 Writing a symbol list

Open the file you are going to work with. This will also open the symbol editor. Click on Group/Symbol, and then press the *Insert* key. A new symbol field is added to the list. Enter the symbol name, type, address/value, and a comment. Press *Enter* to confirm your entry.

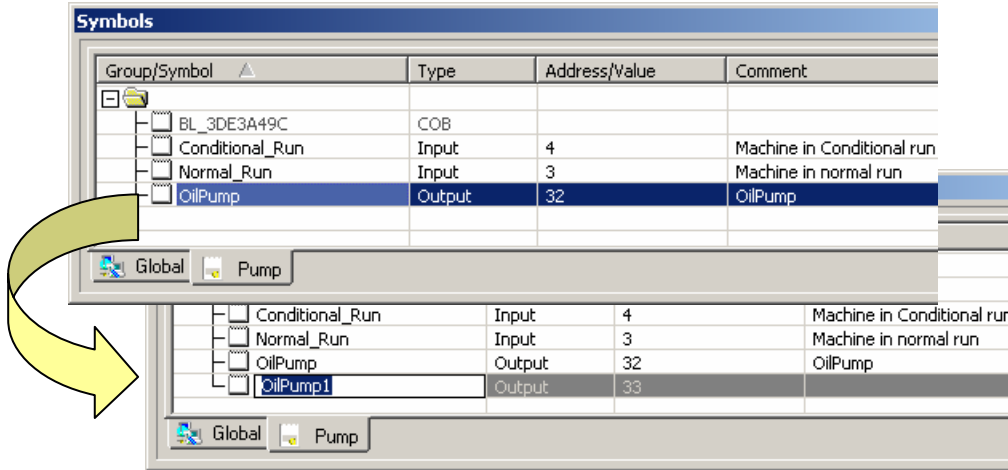

For the next symbol, simply press the *Insert* key. N.B.: The editor automatically copies the previous symbol name and address to the new field, incrementing the address/value by 1 (see picture below). You can accept this name, type and address/value and just edit the comment, or you can overwrite the entry with a new name, type, address/value and comment.

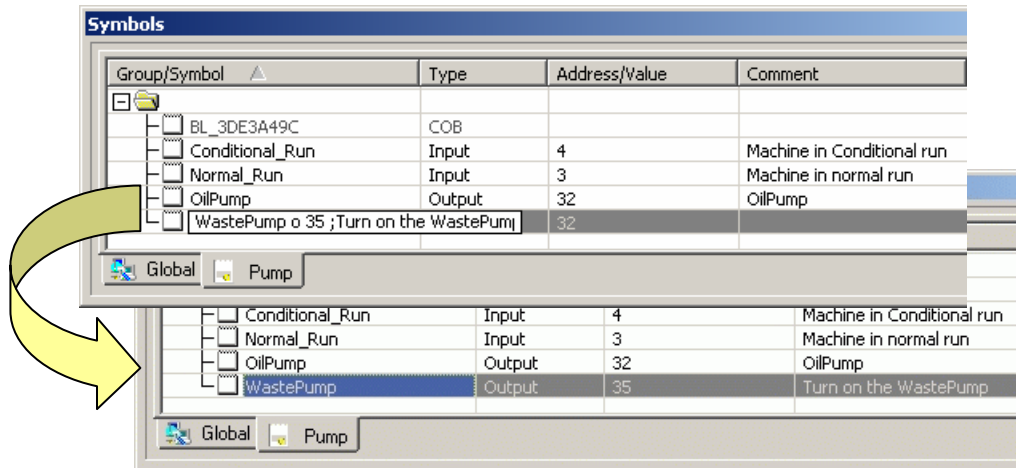

If you have already started a list and would simply like to add a symbol, just click on the last symbol, press *Insert* and another symbol field will be opened.

3.5.2 Adding several symbols to the symbol editor

You can add a range of symbols to your list if you want. Just enter the symbol name with the first and the last element number as shown, (Drainpumps1..8 O 32 ;Pumps in building F). 8 is the number of symbols, O is for output and 32 is the start address of the range you are entering. Press *Enter* and the symbol editor will complete the list.

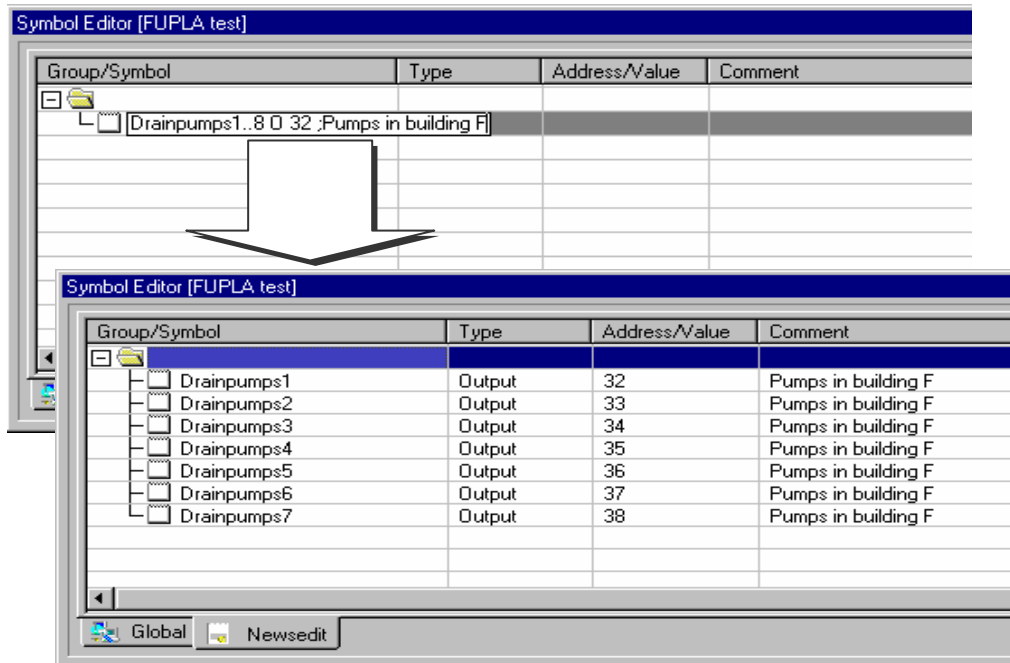

3.5.3 Referenced symbols

Une liste de symbole peut aussi se référer à un symbole particulier. Sélectionner le menu *Symbols, Advanced, Options...* pour ouvrir la fenêtre *Symbol Editor Options*, entrer le symbole et cochez la case *Create reference for symbol*. Confirmer par *OK*.

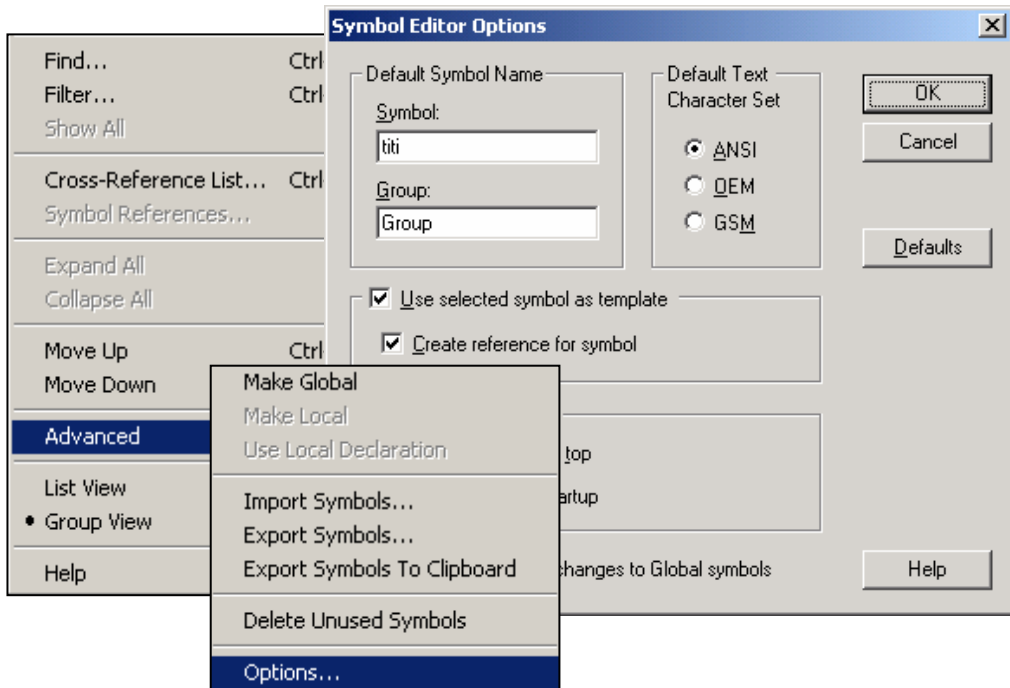

Another option is to enter a symbol and address in the symbol editor, open the options window, (select the menu path: *Symbols, Advanced* then *Options*) enter the symbol and select *Create reference for symbol*.

Click *OK*, and then highlight the symbol in the editor. Press the *Insert* key to enter the symbol, incrementing it by one. This can be helpful if you have a string of inputs or outputs and need to change their physical address location in the software. You only have to change the first one and all the others will follow.

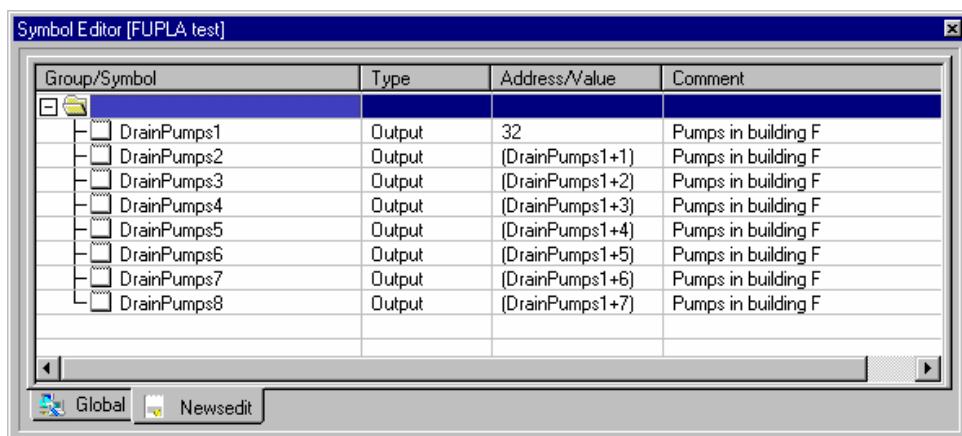

3.5.4 Importing symbols from “EQUATE” statements

If you have old PG4/3 Instruction List files containing EQU or DOC statements, then simply mark the statements and import the corresponding symbols with menu path: *Tools, Move EQUs and Docs to Symbol Table*. The symbols are then moved from the program file into the symbol list.

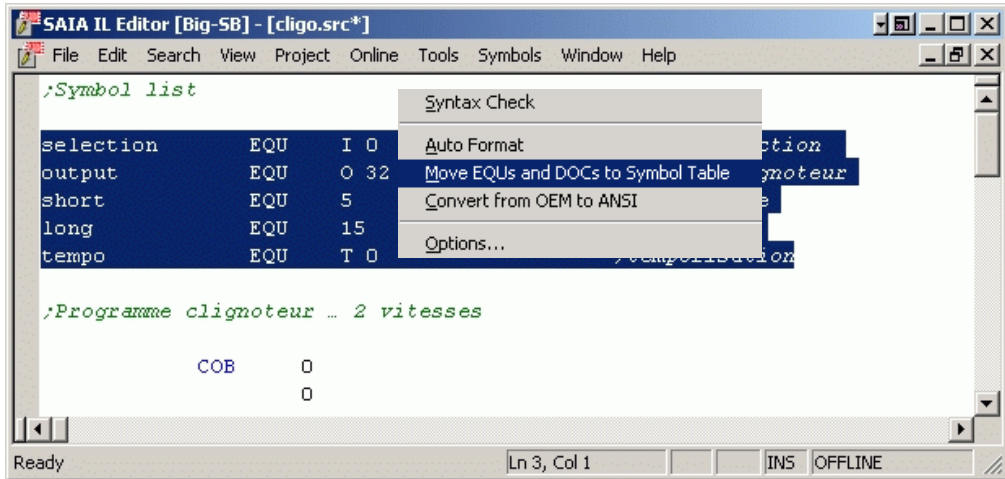

3.5.5 Importing symbols from another application

Alternatively, symbols can be imported from another program (Electro CAD, Visi-Plus,...) and used inside your project. This makes documentation consistent throughout the project and labels in your electrical drawings will be the same as in the program code. Simply use the export function in your CAD to export the symbols into a text file and import them into the symbol editor again.

3.5.6 Adding a symbol while typing your program IL

You can simply write your program and each time you enter a new symbol, add "*= type address ;comment*" to the line. When you press *Enter* the symbol definition will be moved into the list. Example:

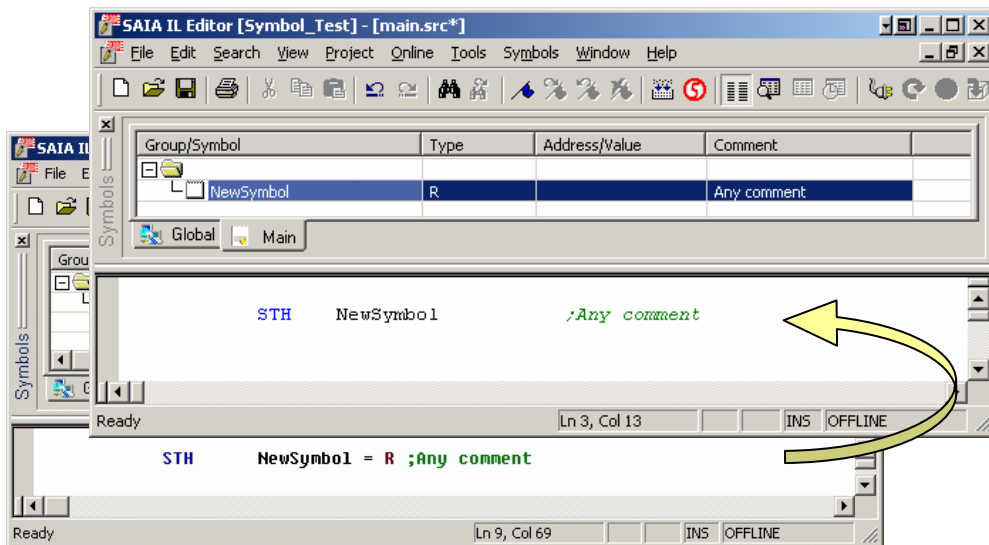

3.5.7 Adding a symbol while typing your program in Fupla

The Fupla editor works in exactly the same way. You can enter new symbols to the Symbol List directly from the Fupla input/output field.

Syntax: *symbol type [address] [;comment]*

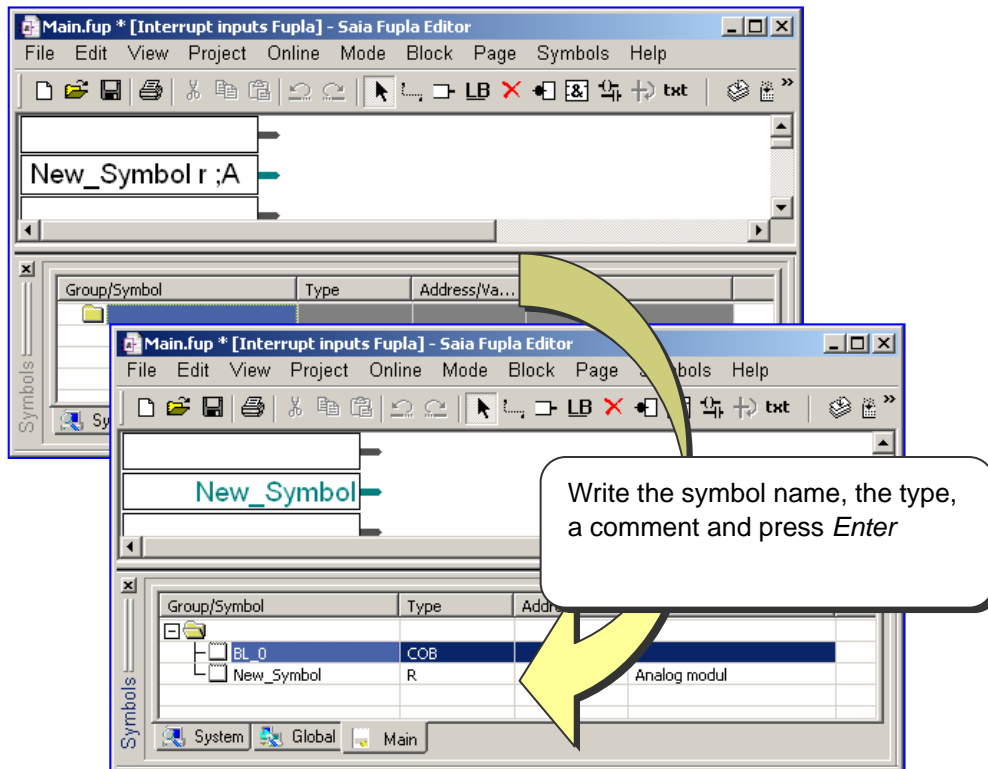

3.5.8 Transferring symbols

To avoid entering symbol names several times in one program (running the risk of typing errors) one or more symbols can be selected from the symbol editor and dragged into the Fupla or IL program.

Example: showing selection of several symbols

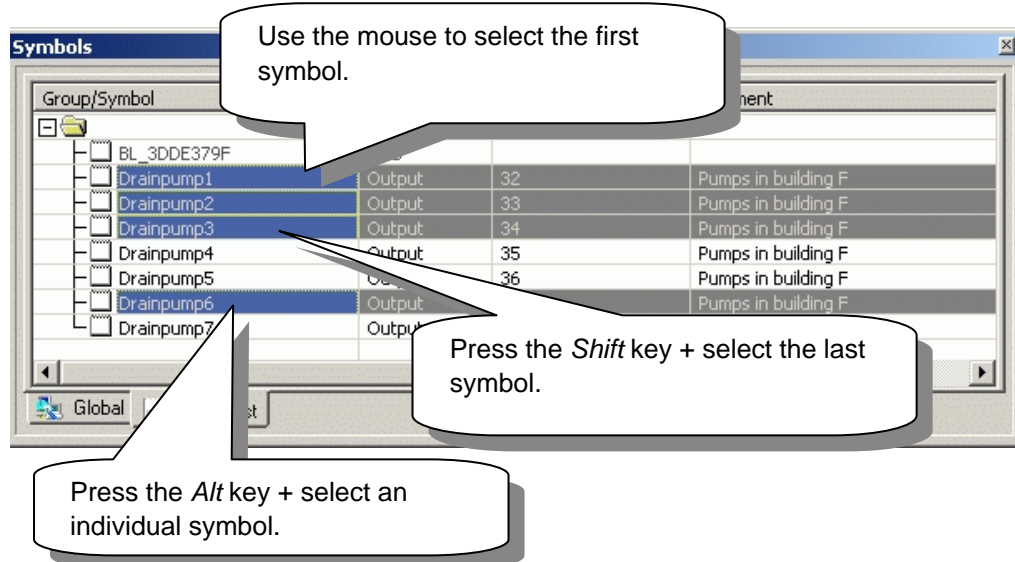

Example: showing symbol dragged into the Fupla or IL editor

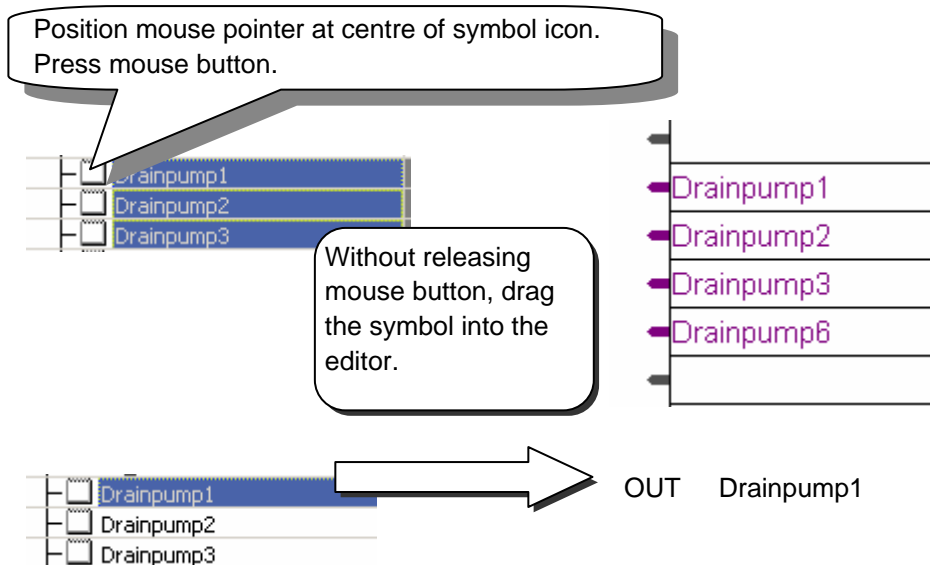

3.5.9 Auto complete symbols

If you use long symbol names, your program will be easier to read. However, it would be annoying to have to re-enter a long symbol name every time you use it in the program. This can be avoided by simply entering the first letters of a symbol and then pressing the *Ctrl+Space* keys to look up all the symbols that match those letters.

Example:

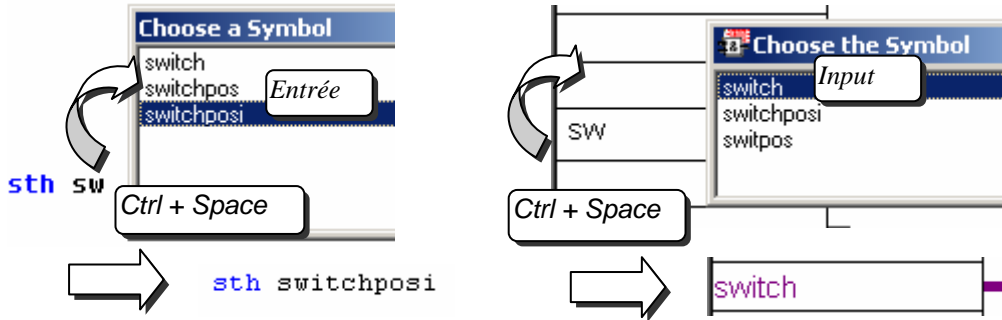

3.5.10 Auto allocation

Until now we have always declared the elements like this:

Symbol name Type Address Comment

Example: Pumpspeed R 2000 ;Speed in l/min

If you are entering any symbol type other than an input or an output, you do not have to enter an address for them. If you do not enter an address, the PG5 will assign an address to your element at build time. We call this automatic (or dynamic) allocation. The PG5 will look up the address range configured in the *Software Settings* for that element and assign an address during the build process.

Example: Pumpspeed R ;Speed in l/min

If you declare a register in your program without giving it an address:

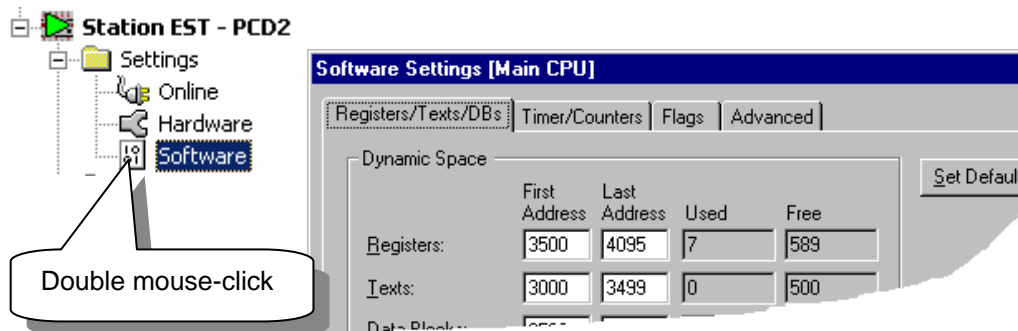

The register will be allocated a number between 3500 and 4095 during the build process. This is because we declared the dynamic space between 3500 and 4095 for registers in the *Software Settings*.

3.5.11 Entering text

In order to add a text to your PCD the text must first be declared. This can be done by entering the X data type after the symbol name.

Example:

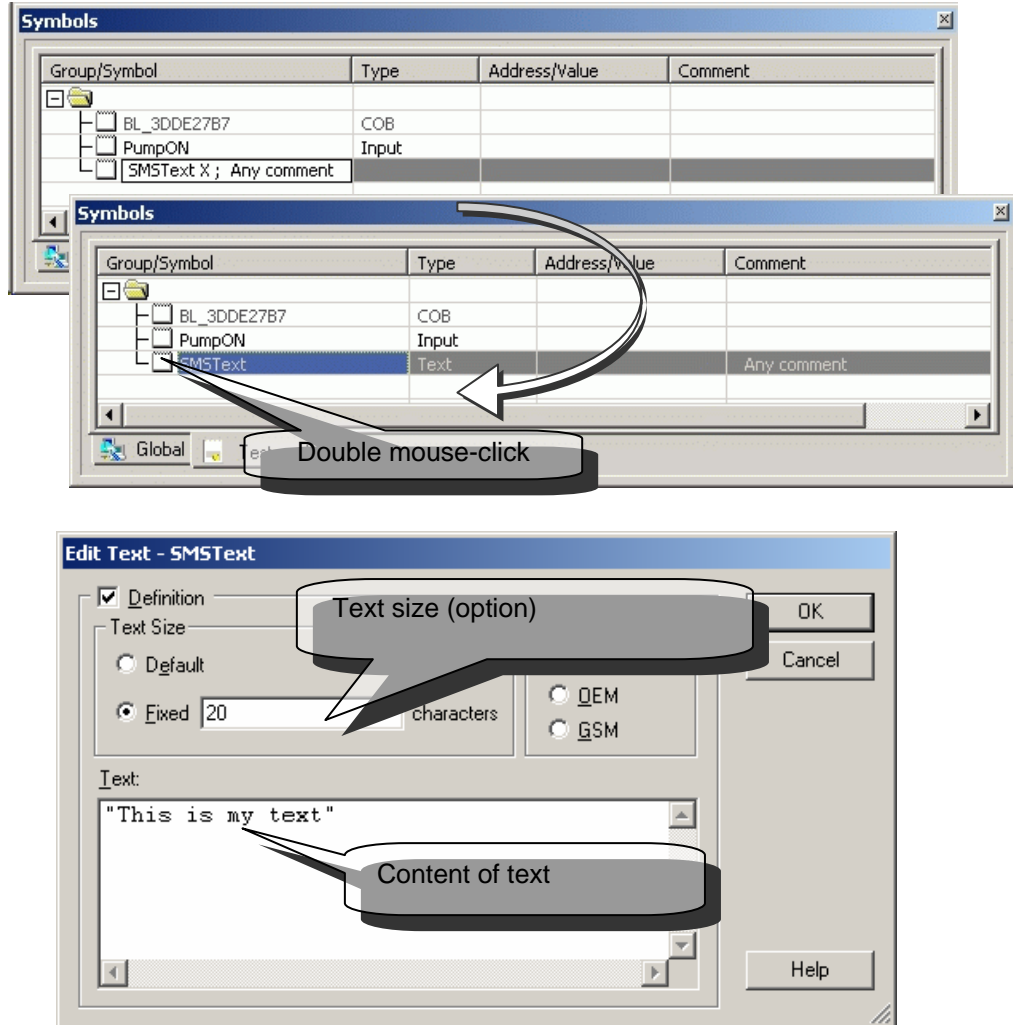

Do not forget to use " ", otherwise the text will not be valid.

3.5.12 Entering DBs

DBs have a special editor too. Read the help for more information

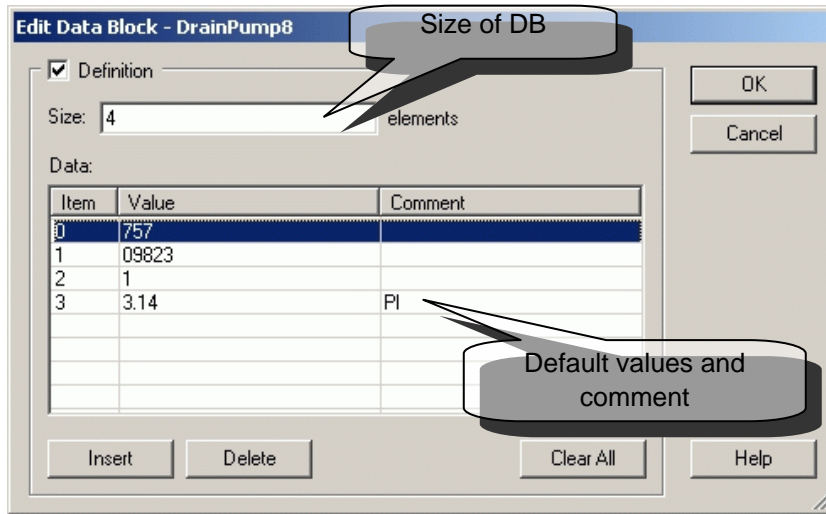

3.5.13 Search for a symbol

Often a symbol will be used several times inside the program file or even in several different files. After a successful build of your program you can right-click with the mouse on any symbol and start the *Cross reference List* function.

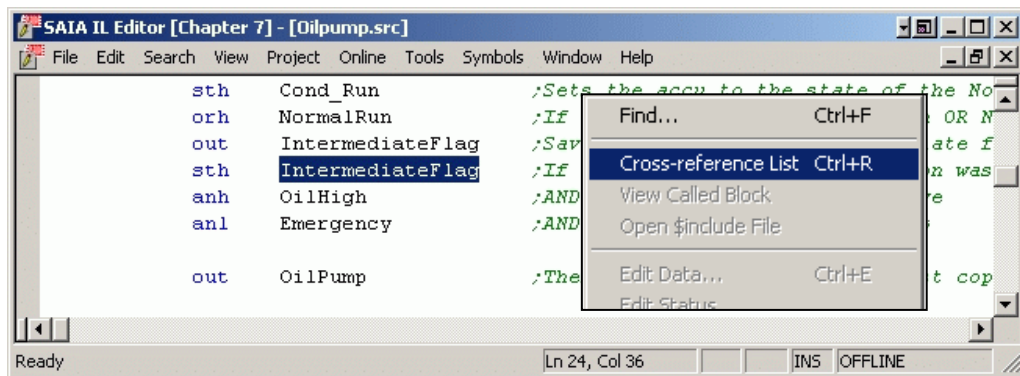

The cross-reference function displays the filename, line number and how many times a certain symbol was used. Double-click on any location in the reference list to open the program file with the cursor on the symbol concerned.

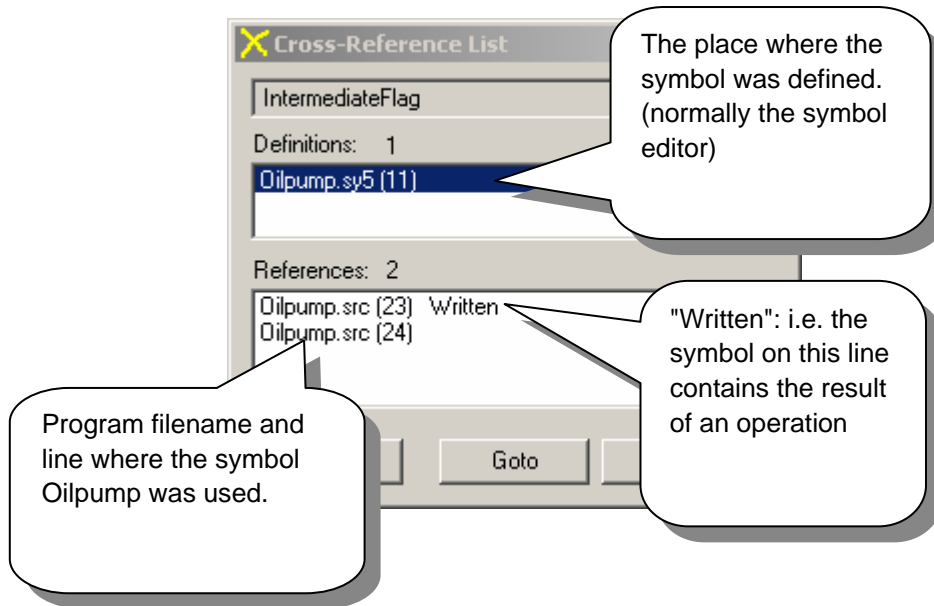

The cross-reference tool not only works in S-Edit and Fupla but also in the different views which are available in the project manager.

Example: Block Structure view

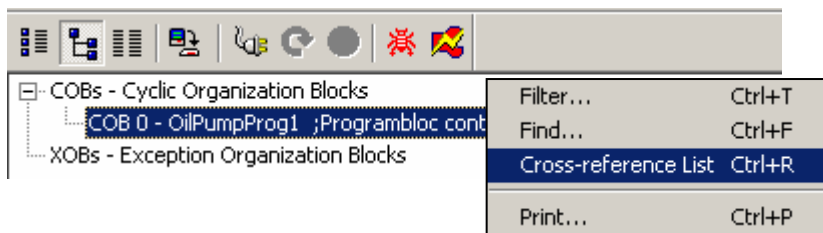

3.5.14 Arranging your symbols

Symbols are listed in the order you enter them. This means that symbols entered at the same time will stay together even when new symbols are added later.

3.5.15 Rearrange in “List View”

You can rearrange your symbols by simply changing from *Group view* to *List view*. Simply click on one of the tabs in order to arrange them by: Name, Type, Address or Comment

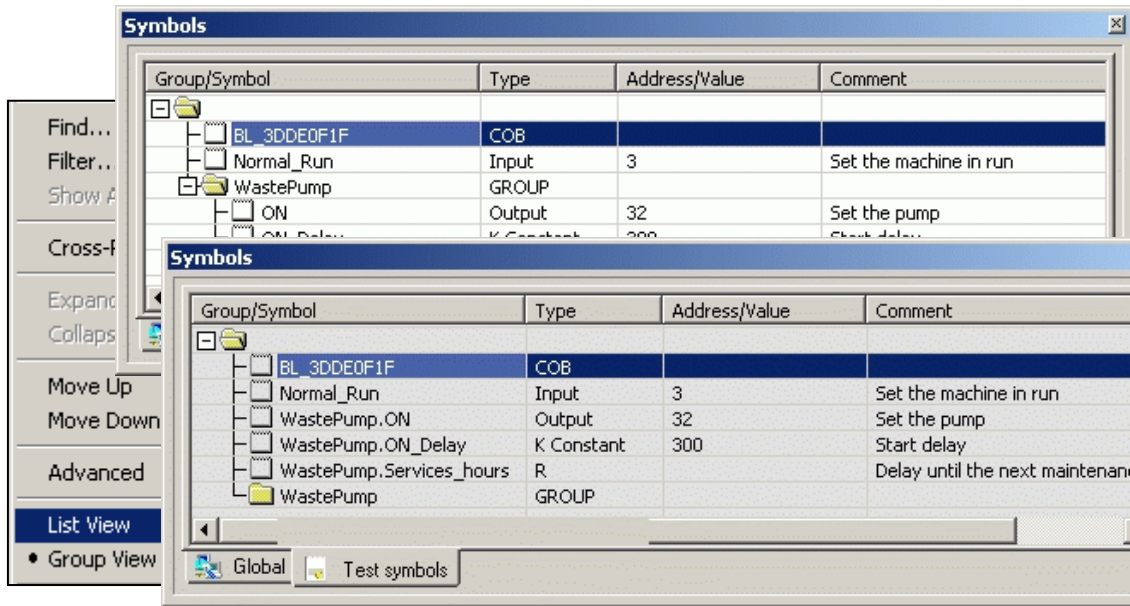

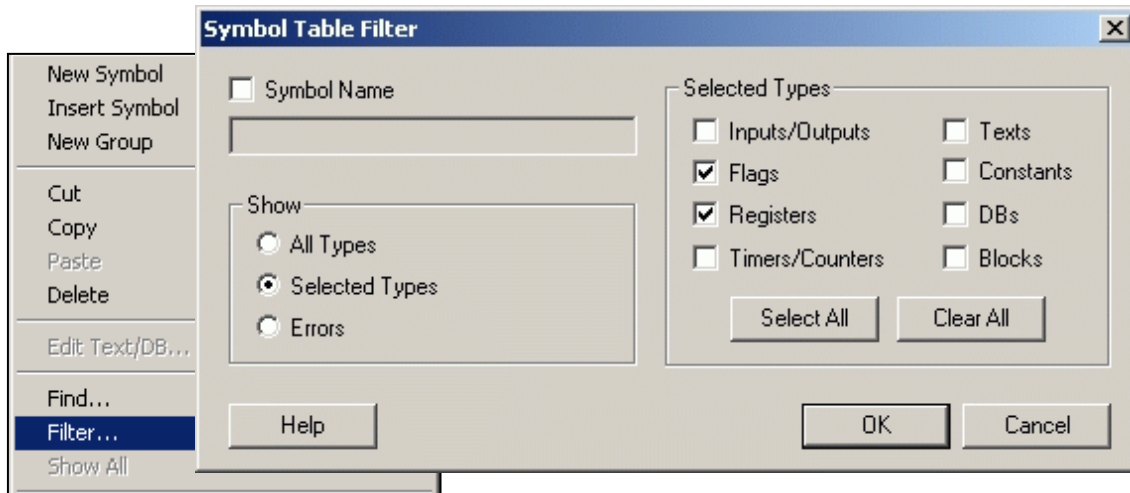

Display with filter

When you change back to *Group View* the old order is re-established. If you have a lot of symbols in your list it is sometimes convenient to display only certain types, or only symbols with a certain name.



The filter function selects the view. As soon as the filter is active your symbols will have a different icon.

Example : Symbol editor shows all Elements => 
 Filter is active>Not all the symbols are displayed => 

3.5.16 Exporting symbols

A program's symbol list can be exported to other applications (such as Exel, Visiplus or Word) for example, to produce your commissioning report.

Example showing symbol export to Exel:

Select context menu *Export Symbols* from the symbol editor.

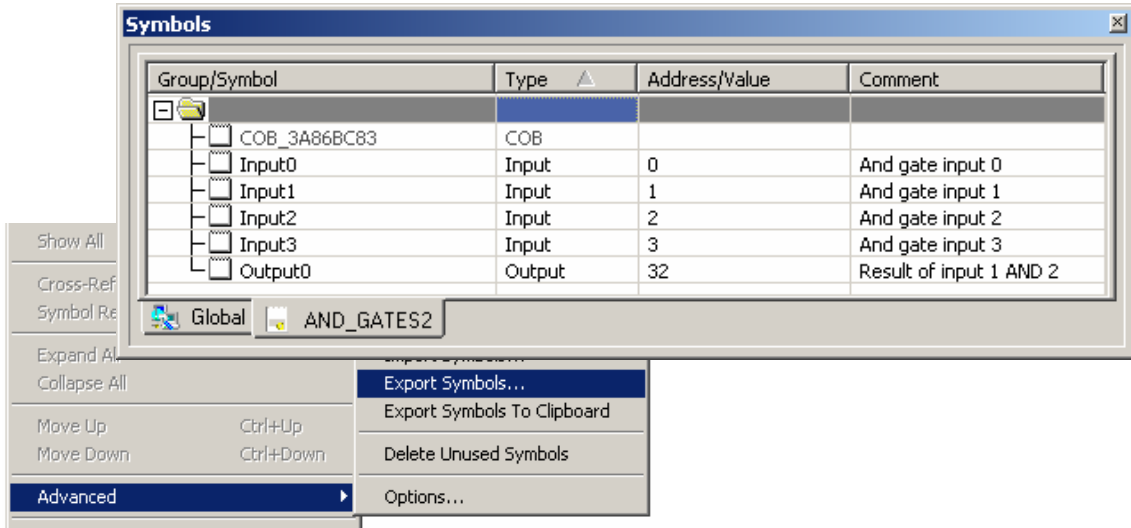

When exporting a symbol list to Exel, we strongly advise use of the *Tab separated Text file* format (*.txt). You will obtain better results than if you use the *Exel* file format option (*.xls).

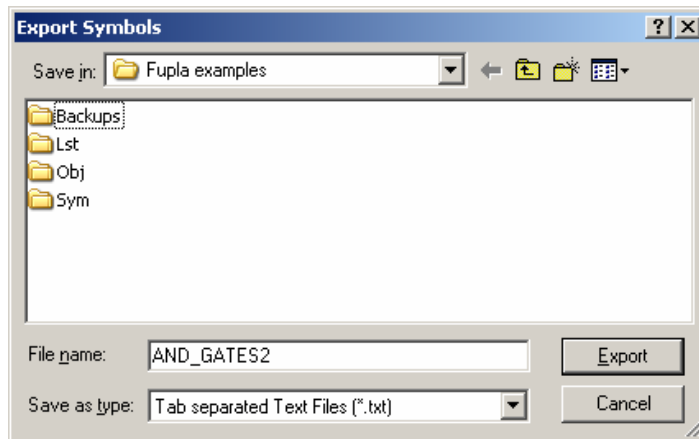

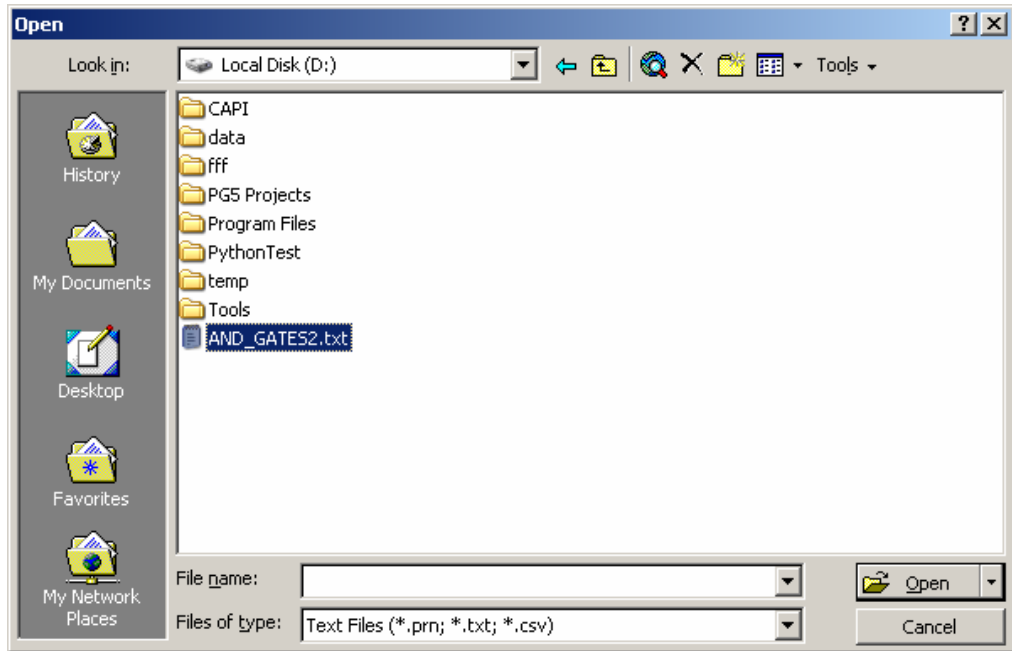

Start up Exel and open the text file with the exported symbols.

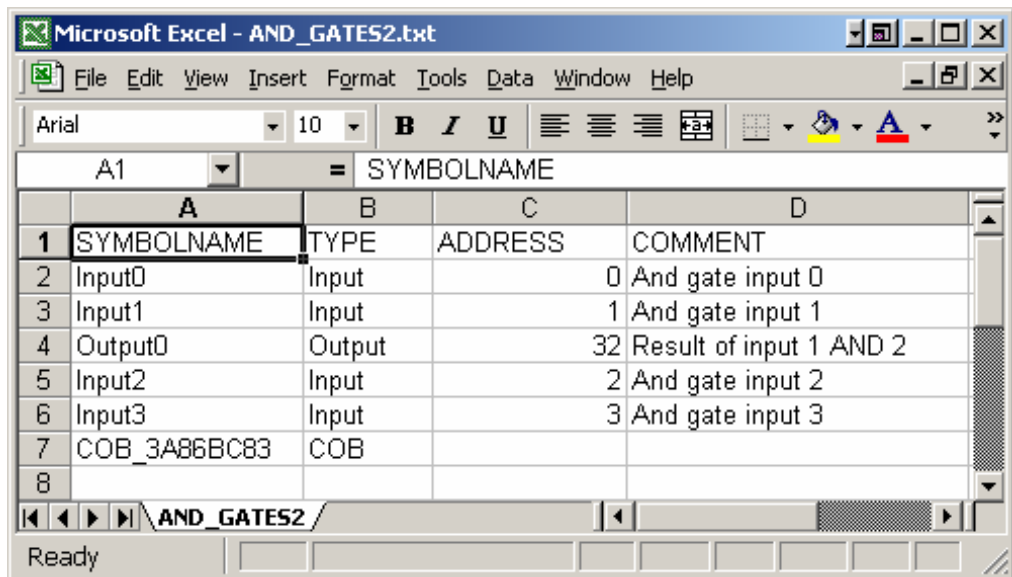

3.5.17 Importing symbols

It is also possible to write a list of symbols with the Exel editor and import them into a PG5 project. To do this, edit a symbol file as shown below and save it in *Text(Tab delimited)* format (*.txt).

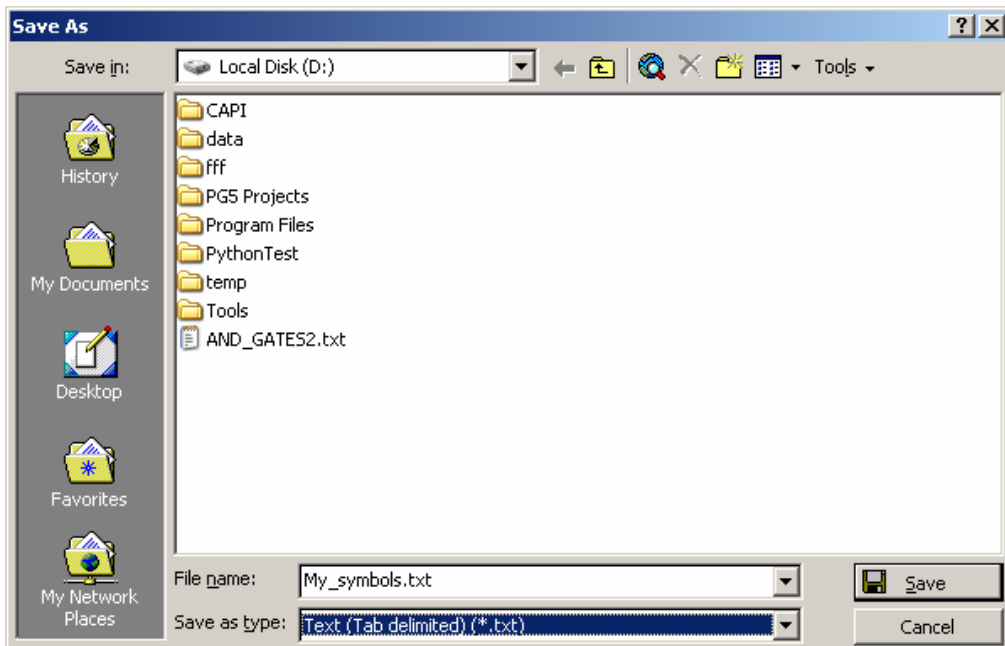
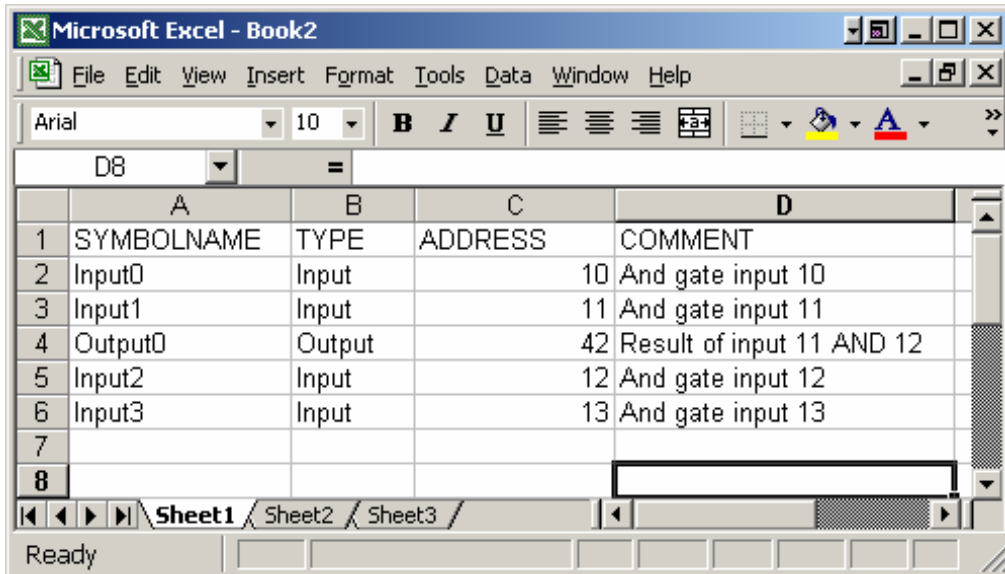

In the PG5 symbol editor, select the context menu: *Advanced, Import Symbols*, then select the file and import it.

If any difficulty is experienced, check that the Exel file has been properly closed.

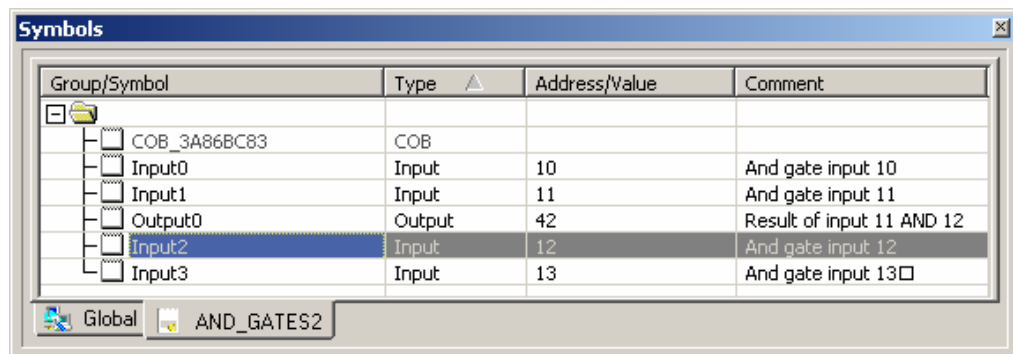
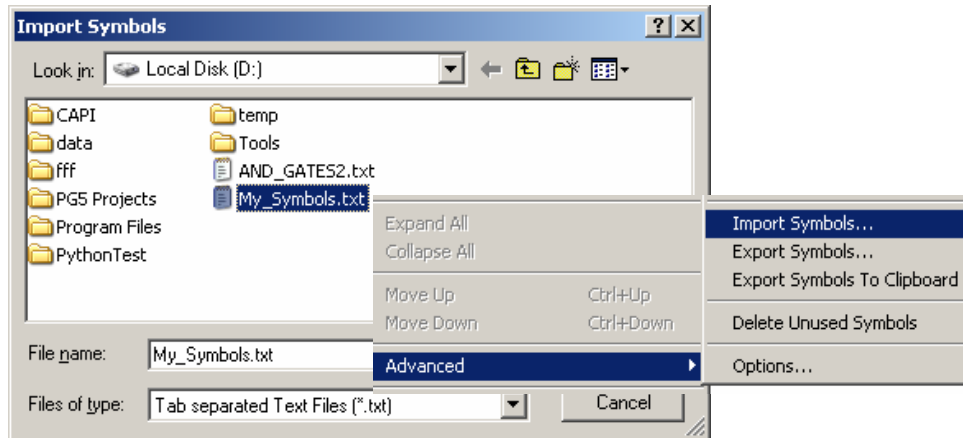

3.5.18 Initialization of symbols

There are two ways to initialise symbols used by the PCD:

- initialization during a PLC coldstart (power-up)
- initialization when the program is downloaded into the PCD

During coldstart

The initialization of symbols during a coldstart is done in XOB 16. This function block is processed once only, during a PCD coldstart. The user writes IL code to initialize symbols in XOB 16.

Example: initialisation of a flag and a register during a PCD coldstart

Program in IL

```

XOB 16 ;Coldstart block
LD R 5 ; R 5 = 256
      256
SET F 10 ;F 10 = 1

EXOB

COB 0 ;Cyclic block
  0
...
;Your program
...
ECOB
    
```

Program in Fupla

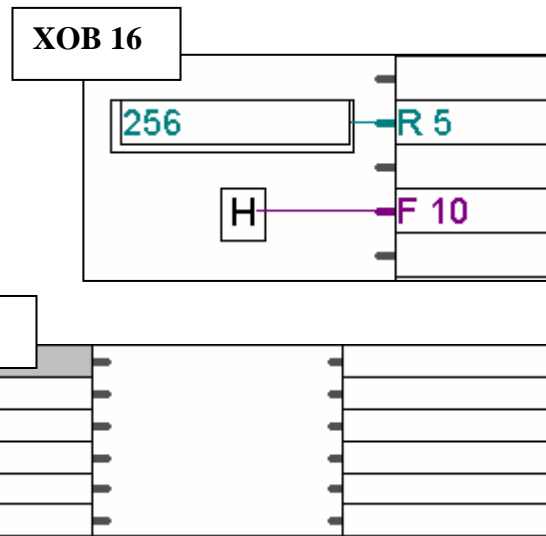

For more detailed information about COB and XOB blocks, please consult chapter 5 of this document.

When downloading program

To initialise a symbol when the program is being downloaded to the PCD, the symbol address should be followed by := (colon equals), which is in turn followed by the initialisation value.

Example:

Group/Symbol	Type	Address/Value	Com
BL_3E315C55	COB	0	
SymbolA	R	5:= 256	
SymbolB	F	10:=1	



Be careful

Remember to tick the following option when downloading the program:

 First-time Initialisation Data

3.5.19 Symbol names

Symbol names are names which can be assigned to elements in the PCD (inputs, outputs, flags, registers, COBs etc). Symbol names can be up to 80 characters long and are not case-sensitive unless they contain accented characters. MotorOn is the same as MOTORON, but GRÜN is not the same as grün.

Symbols have to start with a letter (a-z, A-Z): a number will not be accepted. Within the symbol, numbers, letters and underscores (_) can be mixed as desired. A symbol name cannot include a space character.

Reserved words cannot be used as symbol names.

3.5.20 Reserved words

The following words are reserved, and cannot be used as symbol names:

- Assembler instructions : PUBL, EXTN, EQU, DEF, LEQU, LDEF, MACRO, ENDM, EXITM...
- Codes de commande et notations abrégées des différents types de données du PCD : I, O, F, R, C, T, K, M, COB, FB, TEXT, X, SEMA, DB,
- Special instructions MOV : N, Q, B, W, L, D,
- Conditional codes : H, L, P, N, Z, E,
- All instructions mnémonics,
- Symboles prédéfinis,
- Internal symbols reserved to the automatic resources allowance, begin with an underlined char. Example: TEXT, F
- Intern symbol __CSTART__, used with \$\$.

Content

CONTENT	1
4 PROGRAM WITH FUPLA	3
4.1 Introduction	3
4.2 Preparation of a Fupla project	4
4.3 Create new project	4
4.4 Organization of a Fupla window	5
4.5 Editing <i>Symbols</i>	6
4.5.1 Add new symbol to <i>Symbols</i> list	7
4.5.2 Symbols addressing modes	8
4.5.3 Using a symbol from the <i>Symbols</i> list in an Fupla program	9
4.5.4 Local and global symbols	10
4.6 Edit connectors	11
4.6.1 Place connectors	11
4.6.2 Edit symbol inside connector	11
4.6.3 Quick way to place a symbol and its connector	11
4.6.4 Drag, Copy/Paste, Delete symbol	11
4.6.5 Copy/Paste, Delete connector	12
4.6.6 Stretch connectors	12
4.6.7 Move connector vertically	12
4.7 Editing a Fupla function	13
4.7.1 FBox selector	13
4.7.2 Edit FBox	14
4.7.3 Edit stretchable FBox	14
4.7.4 Edit logical inversion	14
4.7.5 Dynamization	15
4.7.6 Comments	15
4.7.7 FBox Help	15
4.8 Links between FBoxes and connectors	16
4.8.1 Link by shifting FBox	16
4.8.2 Link with automatic routing	16
4.8.3 Multiple link with automatic routing	16
4.8.4 Link all inputs/outputs on an FBox to connectors	16
4.8.5 Delete lines, FBoxes, connectors or symbols	17
4.8.6 Move FBox/connector vertically without undoing links	17
4.8.7 Insert FBox without undoing link	17
4.8.8 Rules to follow	17
4.9 Editing Fupla pages	18
4.9.1 Insert page	18
4.9.2 Delete a page	18

4.9.3	Page navigation	18
4.9.4	Page documentation	19
4.9.5	Processing of program by the PCD	19
4.10	Copy and paste	20
4.10.1	Copy/paste part of a program	20
4.10.2	Copy and paste symbols	20
4.11	Page export and page import	20
4.11.1	Page export	21
4.11.2	Page import	22
4.12	Editing a first Fupla program	24
4.12.1	Objective	24
4.12.2	Method	24
4.12.3	Programming	26
4.13	Building the program	27
4.14	Downloading the program into the PCD	28
4.15	Finding and correcting errors (Debug)	28
4.15.1	Go On/Offline – Run – Stop - Step-by-step	28
4.15.2	Breakpoints	29
4.15.3	Display symbols or addresses	30
4.15.4	Display symbol state with Fupla	30
4.15.5	Edit symbols online	30
4.15.6	Display symbol state with <i>Watch window</i>	31
4.15.7	Setting the PCD clock	32
4.16	Adjust windows	33
4.16.1	Types of adjust parameter	34
4.16.2	Initialization of HEAVAC FBox	35
4.16.3	HEAVAC FBox with adjust parameters	36
4.16.4	Mini HEAVAC application	36
4.16.5	Parameters after <i>download program</i>	37
4.16.6	Writing parameters on-line	37
4.16.7	Read on-line parameters	38
4.16.8	Restore default parameters	38
4.16.9	Define symbols for adjust parameters	39
4.16.10	Define adjust parameter addresses	40
4.17	Commissioning an analogue module	41
4.17.1	Acquisition of an analogue measurement	41
4.17.2	Example for PCD2.W340 analogue input modules	42
4.17.3	Example for PCD2.W610 analogue output modules	43

4 Program with Fupla

4.1 Introduction

The Fupla editor is the simplest, fastest introduction to programming PCD controllers. The name "Fupla" means "*F*unction *PL*An", a graphical programming environment in which the user draws programs with the aid of hundreds of functions. These functions are organized into libraries covering the basic applications, with more specialized functions added for certain professional domains. The special libraries include: a HEAVAC library for heating, ventilation and air conditioning, a modem library for networking PLCs to exchange data via telephone line (analog, ISDN, GSM, GPRS), the messages SMS, Pager and DTMF.

Other libraries for communications networks LON, EIB or Belimo products are available too.

The great advantage of Fupla lies in the fact that the user can put a PCD into service without having to write a single line of code, and without any particular programming knowledge.

4.2 Preparation of a Fupla project

For the preparation of an example, it is advisable to create a new project to contain the files for editing the Fupla program.

4.3 Create new project

In the SAIA Project Manager window, select the menu command *Project, New...* and create a new project.

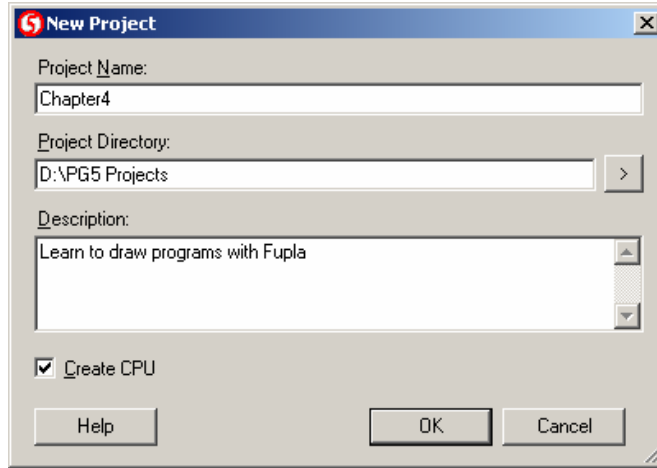

To create a new program file in this project, click on the *New File* button or use the right mouse button:

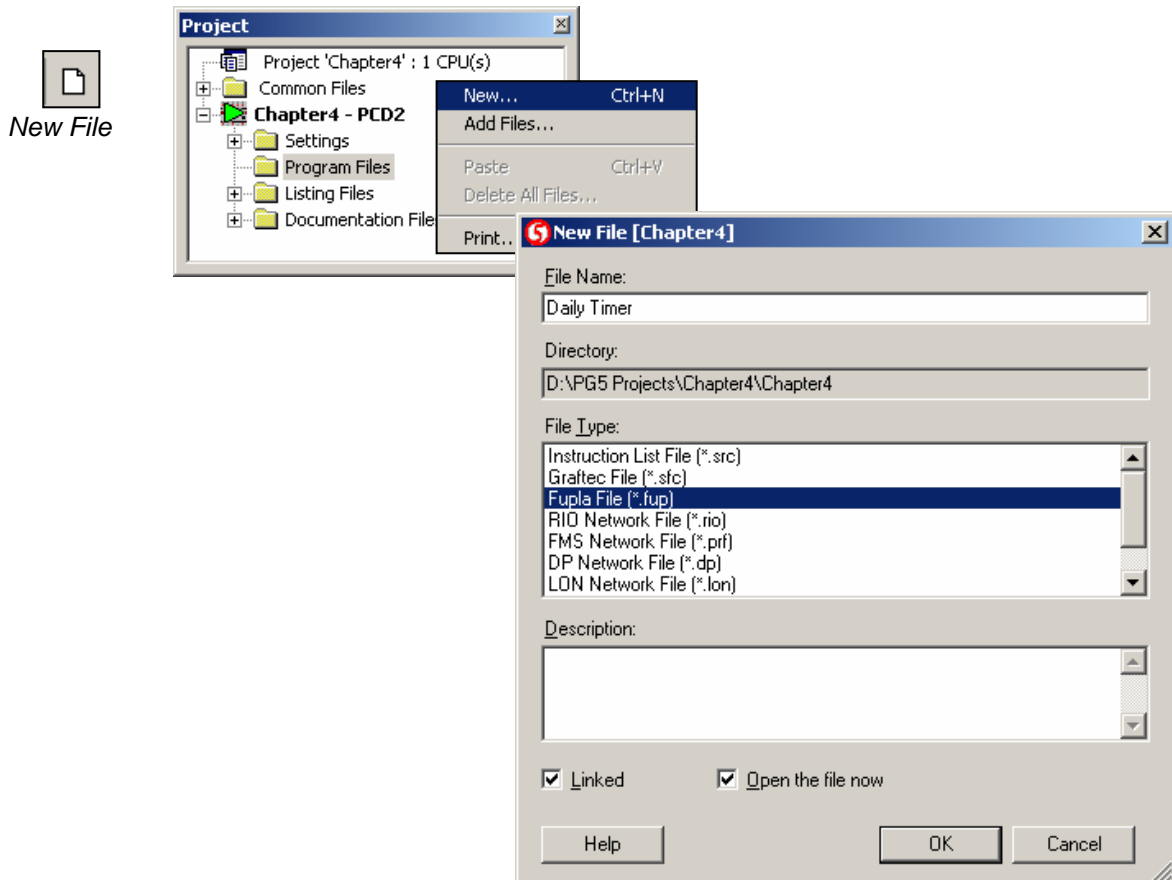

4.4 Organization of a Fupla window

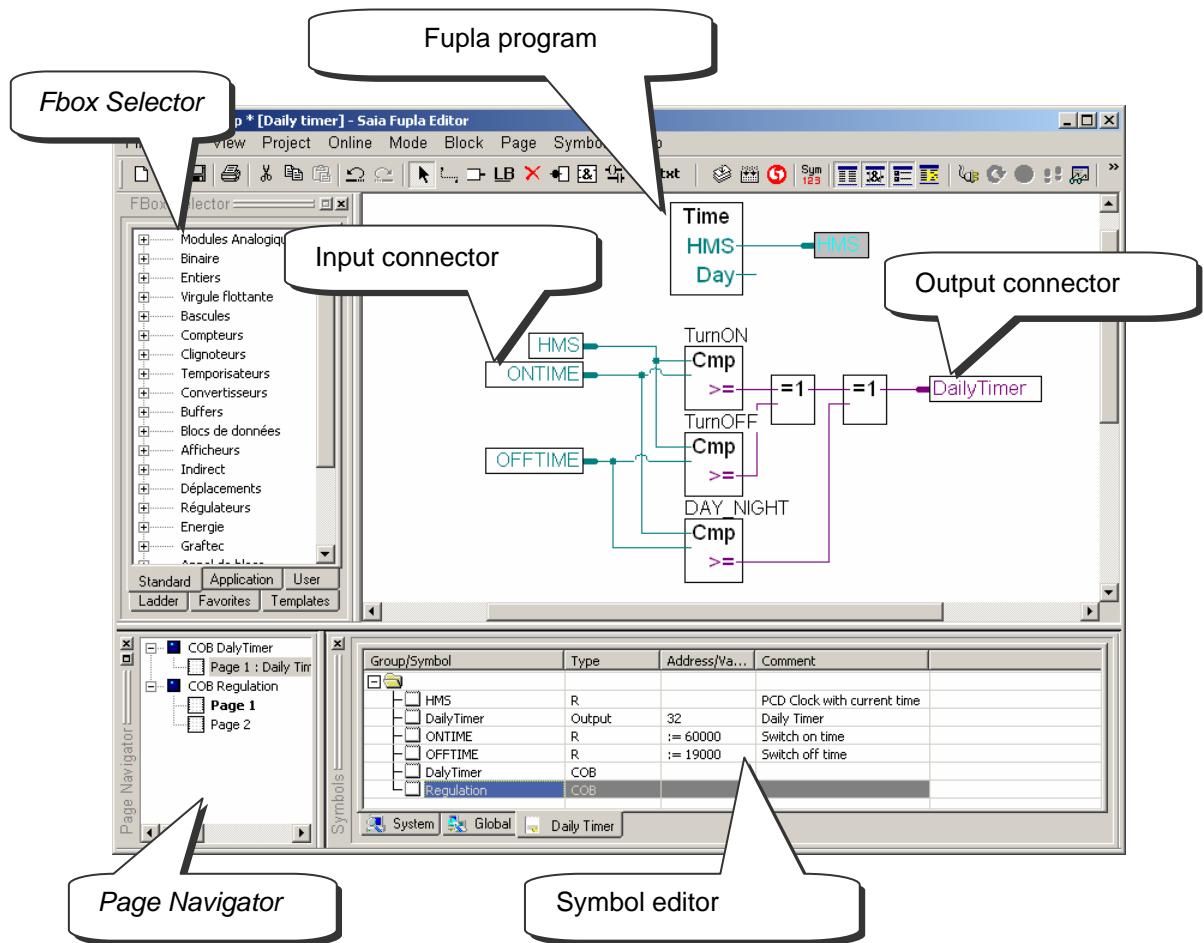

The PCD reads the information represented by the input connectors, evaluates it according to the program and writes the results to the output connectors. The symbols used by the program are all listed in the *Symbols* window. All symbols are allowed in the input and output connectors, except *input* and *constant* type symbols. Digital inputs and constants provide read-only data, and can therefore only be used in the input connectors.

In the middle of the page we have the program, made up of different graphical functions selected from the *FBox selector* window. The links represent the exchange of data between the different functions. The colour of these links defines the type of data: purple for binary (Boolean) information, blue for integers and yellow for floating-point numbers. Data which is different in type or colour cannot be linked together without first being converted to a common type (FBox: *Standard, Converter*).

If the program uses several pages, the *Page Navigator* window allows pages to be deleted and helps you move around the program structure quickly.

4.5 Editing Symbols

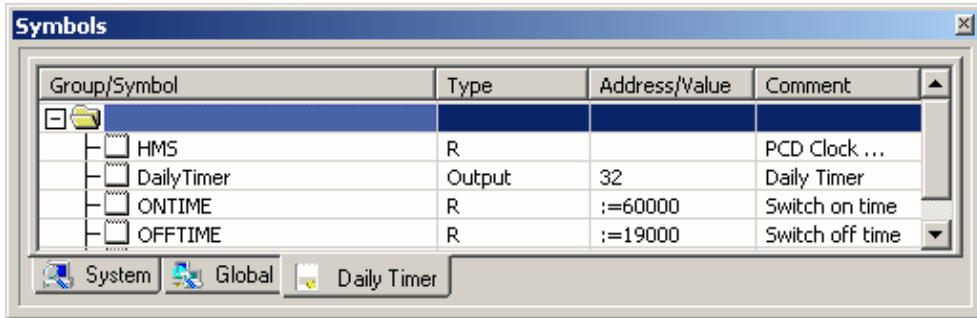

The *Symbols* window contains a list of all symbols used in a program. It can be viewed with the *Show/Hide Symbol Editor* button, or via the menu command *View/Symbol Editor*. Each line defines all the information relative to an input, output, register and constitutes a symbol:

Symbol

A symbol is a name that indicates the address of an input, output, flag, register,... It is advisable to use symbol names when editing a program, rather than the direct address of a flag or register. This allows correction of an address or data type from the *Symbols* window. Instead of having to copy the correction to each connector of the program, it is only necessary to correct it in the *Symbols* window. There is no risk of forgetting to correct the contents of one connector in the program and creating an error that is hard to find.

Syntax for symbol names

The first character is always a letter, followed by other letters, numbers, or the underscore character. Avoid accented characters (ö, è, ç, ...).

Differences of case (upper or lower) have no significance: MotorOn and MOTORON are the same symbol.

Type

Defines the symbol type: input (I), output (O), register (R), counter (C), timer (T), text (X), DB, ...

Address

Each symbol type has its own range of available addresses:

- Inputs and outputs: dependent on I/O modules inserted in PCD
- Flags: F 0, ..., F 8191
- Registers: R 0, ..., R 4095
- Timers/counters: T/C 0, ..., T/C 1599
- ...

Comment

This comment is linked to its symbol and can be displayed on the Fupla page. Place the mouse on the connector to display its full symbol definition in a bubble.

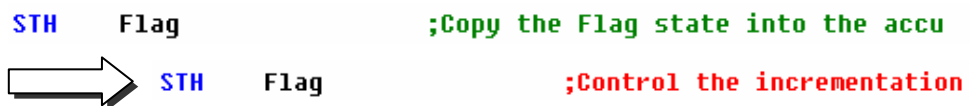

4.5.1 Add new symbol to *Symbols* list

Simple method

To add a symbol to the list, open the *Symbols* window, position the mouse in the middle of the window and right-click to select the context menu *Insert Symbol*. Then fill in the fields: *Group/Symbol*, *Type*, *Address/Value* and *Comment*.

Quick method 1

It is also possible to enter variables for the different information fields from the *Group/Symbol* field. This is more practical and quicker. See example below.

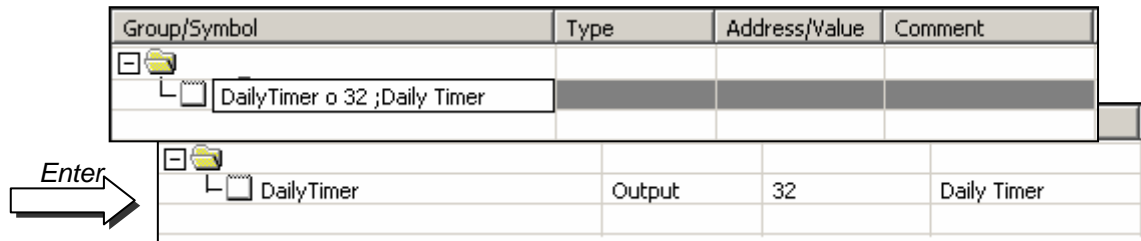

Syntax to follow :

symbol_name type address ;comment

If the new symbol has been defined using the above syntax, pressing the *enter* key on the keyboard will automatically place information in the correct fields.

Quick method 2

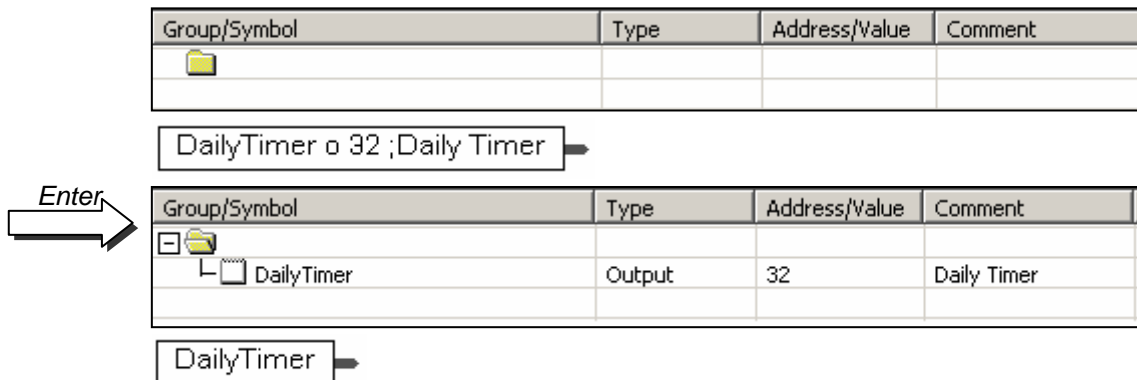



New symbols can also be added from the Fupla connectors. To do this, edit the symbol name and definition with the following syntax below:
 symbol_name type address ;comment

Pressing the *enter* key on the keyboard will automatically place the new symbol on the *Symbols* list, but only if the symbol definition is correct.

4.5.2 Symbols addressing modes



A symbol definition does not necessarily include all the information presented below. We distinguish between three types of addressing:

Absolute addresses

Group/Symbol	Type	Address/Value	Comment
 	Output	32	Daily Timer



The data is defined only with a type and address (e.g. 32), and an optional comment. Using absolute addressing directly in the program is a disadvantage when changing the type or address. The user program will not be updated by changes made in the symbol list. Changes must be made manually for connector of the program. It is therefore preferable to use symbol names, with optional dynamic addressing.

Symbol names

Group/Symbol	Type	Address/Value	Comment
  DailyTimer	Output	32	Daily Timer

The data is defined with a symbol name, type, address and optional comment. Correction of symbol, type or address is supported from the symbol list and each user program connector automatically updated if the symbol is changed.

Dynamic addressing

Group/Symbol	Type	Address/Value	Comment
  HMS	R		PCD Clock with

This is a form of symbolic addressing in which the address is not defined. The address is assigned automatically during the program build. The address is taken from an address range defined by the *Software Settings*. (See Project Manager.)

N.B.: Dynamic addressing is available with flags, counters, timers, registers, texts, DBs, COBs, PBs, FBs and SBs. However, absolute addresses must always be defined for inputs, outputs and XOBs.

4.5.3 Using a symbol from the *Symbols* list in an Fupla program

When a program is edited, symbols already defined in the *Symbols* window may be used in different ways:

Symbol entry from the keyboard

The symbol name is entered in full from the keyboard for each instruction that uses it. This method might allow a symbol name to be edited with a typing error, which would only become evident when the program was built.

Symbol entry by selective searching

Group/Symbol	Type	Address/Value	Comment
HMS	R		PCD Clock with current time
DailyTimer	Output	32	Daily Timer
ONTIME	R	:=60000	Switch on time
OFFTIME	R	:=19000	Switch off time

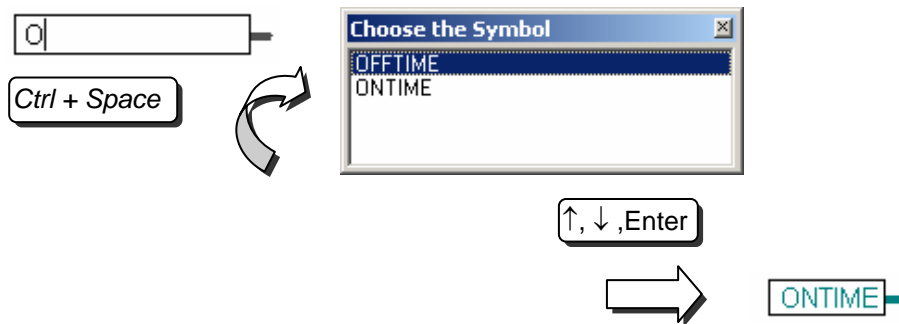

If only the first few characters of the symbol name are entered from the keyboard, pressing the *Ctrl+Space* keys at the same time displays a window showing a list of all the symbols which start with the letters which have been typed. The required symbol can then be selected either with the mouse or the keyboard arrow keys (\uparrow , \downarrow) and confirmed by pressing *Enter*.

Symbol entry by drag-and-drop

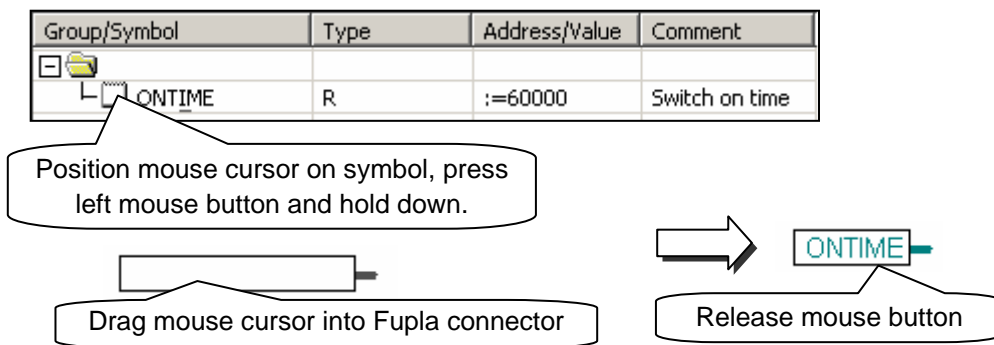

This way of using a symbol excludes any possibility of typing errors. In the *Symbols* window, position the mouse cursor on the definition line of a symbol, press the left mouse button and keep it down. Drag the mouse cursor over an empty connector and release the mouse button. The symbol chosen is automatically added to the connector indicated by the mouse cursor.

It is also possible to drag the symbol onto a free space on the Fupla page. This allows connector and symbol to be added automatically in a single operation.

4.5.4 Local and global symbols

The symbol definition window has two folders : *Global* and *Local*



Definition

Local symbols appear in a folder that bears the name of the file using them. These symbols may only be used within that file. (*Parking lot.src*)

The global symbols that appear in the *Global* folder may be used by all files in the CPU. (*Parking lot.src* and *Ventilation.src*)

Make Local/Global

If necessary, symbols in the *Symbols* window can be moved from the local folder to the global folder, and vice versa.

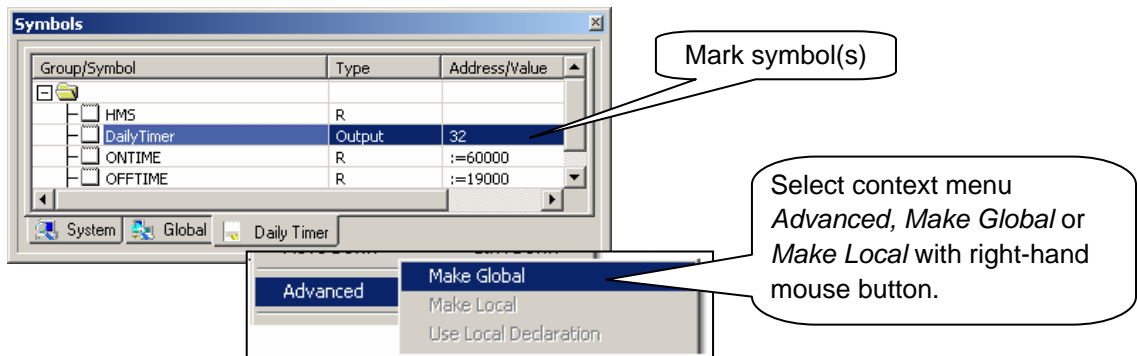

The symbol is moved into the *Global* or *Local* folder

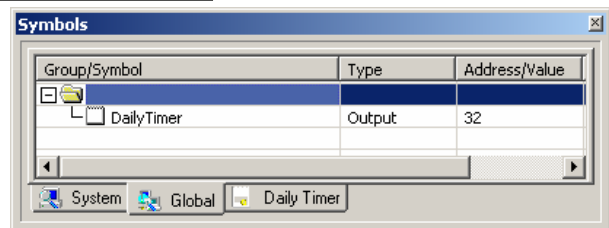

N.B.:

Any new symbol defined directly from the Fupla editor will be added either to the global or local folder, depending on settings in the *Add symbols to Global table* option. See context menu *Advanced, Options* of the *Symbols* window.

4.6 Edit connectors

Input and output connectors can be placed anywhere on Fupla pages, and used to hold the necessary symbols for program functions described by FBoxes.

As a default, each new page may already provide margins with connectors on the left and right. If you prefer new pages not to appear with these connectors, so that you can place them yourself at your own convenience, please deactivate the corresponding option with menu: *View, Options..., Layout, New pages with side connectors*.

To remove any connectors present on the left or right of the page, select menu: *Page, Remove Empty connectors*.

To place connectors once again on a blank page, select menu: *Page, Add Empty Side Connectors*.

4.6.1 Place connectors

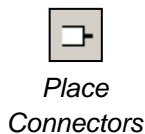

To add a connector and its symbol to a Fupla page, select the toolbar button *Place Connectors* and position the mouse on the Fupla page. A 'read' input connector is added by clicking with the left-hand mouse button. A 'write' output connector is added by pressing the *Shift* key while clicking the left-hand mouse button. The connector you have just added is ready to receive a symbol and a cursor is displayed inside the connector. If you do not wish to edit the symbol inside the connector straight away, press the *ESC* key and place the next connector.

4.6.2 Edit symbol inside connector

To edit or modify a connector symbol already present on the Fupla page, select the connector by double clicking quickly. A cursor will be displayed inside the connector. It is now possible to enter the symbol with its full definition.

Note that newly entered symbols in connectors are automatically added to the symbol list displayed in the *Symbols* window.

4.6.3 Quick way to place a symbol and its connector

Symbols already present in the *Symbols* window can be dragged onto a free space on the Fupla page. This will create a new connector containing the symbol.

If the symbol is dragged onto an FBox input or output, an input or output connector will be linked directly to the FBox.

4.6.4 Drag, Copy/Paste, Delete symbol



Selecting the area shown in red will only affect the symbol. It is possible to select the symbol with the mouse and drag, copy/paste it to another connector, or delete it. The right-hand mouse button will display a context menu with all available operations.

4.6.5 Copy/Paste, Delete connector

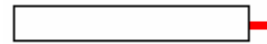

Selecting the area shown in white affects the connector and the symbol it contains. The right-hand mouse button will display a context menu with all available operations.

4.6.6 Stretch connectors

Connectors are stretchable. This means that the number of connectors can be defined by vertical movement of the mouse.

Select button: *Select Mode*

Select connector on area shown in red.

Display context menu by right-clicking mouse.

Selection menu: *Stretch*

Move the mouse vertically to define the number of connectors

Press the left-hand mouse button.

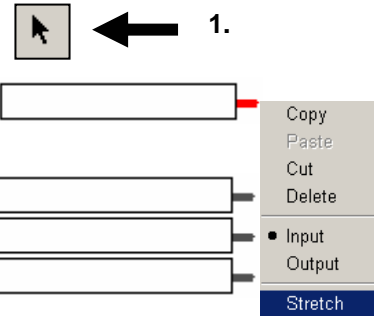

4.6.7 Move connector vertically

To move the connector, place the mouse in the red circle.

Press and hold down the shift-key.

Press and hold down the left-hand mouse button.

Drag the mouse vertically onto a free space on the page

Release mouse button and shift-key

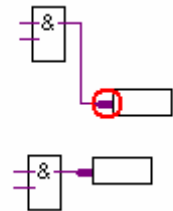

4.7 Editing a Fupla function

4.7.1 FBox selector

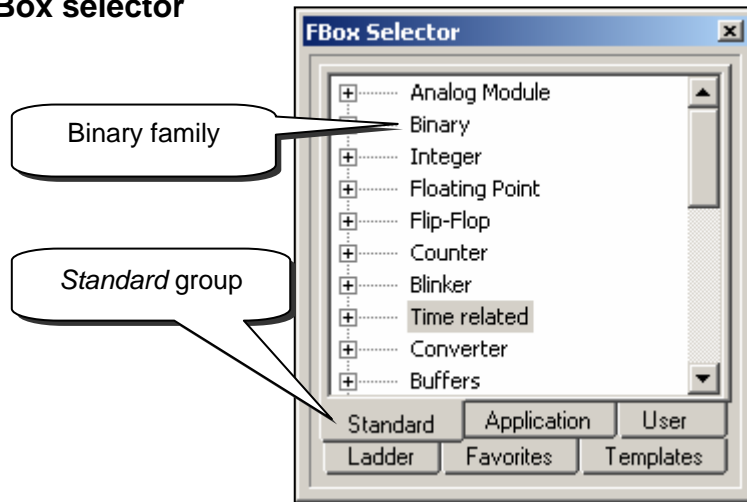

Add FBox

All the graphical functions (FBoxes) needed to produce programs are listed in the FBox selector window. They are divided into groups.

The *Standard* group comprises all the basic functions needed by all users.

The *Application* group comprises functions that are specific to certain specialized professional domains.

The *Ladder* group comprises all the functions required for ladder diagram programming in the form of contact plans.

Each group is in turn subdivided into families containing all the functions that cover a particular field of application. For example, with the *Standard* group we have the following function families:

<i>Binary</i>	FBoxes for producing logical equations
<i>Integer</i>	FBoxes for arithmetic with whole numbers
<i>Floating Point</i>	FBoxes for floating point arithmetic
<i>Counter</i>	FBoxes for counting tasks
<i>Time related</i>	FBoxes for time-related tasks
<i>Analogue Module</i>	FBoxes for the control of analogue modules
<i>Communication</i>	FBoxes for exchanging registers, flags, ... on the S-Bus network or Ethernet
<i>Converter</i>	FBoxes for converting binary to integer, integer to floating point, ...

...

4.7.2 Edit FBox

The functions needed for writing a program are selected from the FBox Selector, then inserted into the Fupla program.

1. Select the *Add FBox* button or *Show/Hide FBox Selector*.
2. *FBox Selector*.
3. Open an FBox family.
4. Select an FBox.
5. Position the FBox on the page being edited,
6. then press the left mouse button.

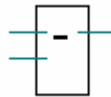

4.



1.

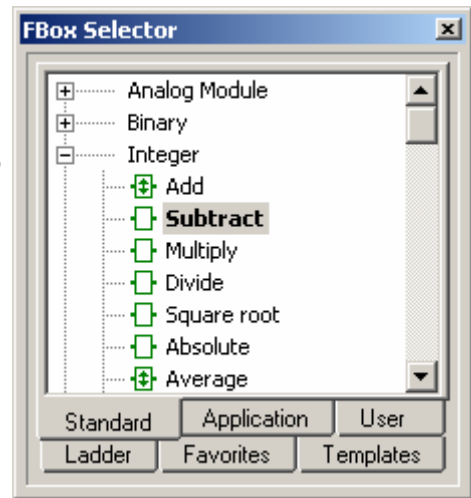

4.7.3 Edit stretchable FBox

Certain FBoxes are stretchable, which means that the number of links can be defined by vertical movement of the mouse.

1. Select the *Add FBox* button or *Show/Hide FBox Selector*.
2. *Show/Hide FBox Selector*.
3. Open an FBox family.
4. Select an FBox.
5. Position the FBox on the page being edited,
6. then press the left mouse button.
7. Move the mouse vertically to define the
8. number of inputs.
9. Press the left mouse button.

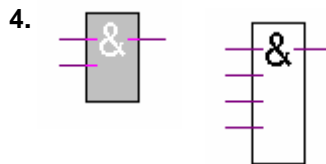

4.



1.

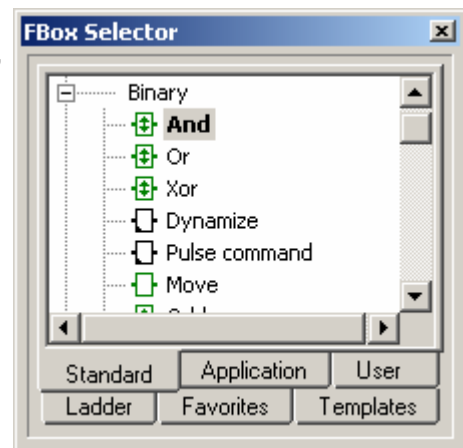

4.7.4 Edit logical inversion

1. Select the *Invert Binary Connector* button.
2. Position the mouse pointer on the input or output link of a logic function and press the left mouse button.

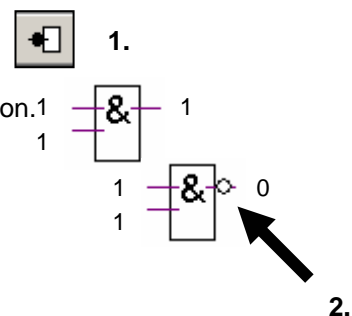

1.

2.

4.7.5 Dynamization

The inputs of certain binary FBoxes have been 'dynamized'. They only take into account the positive edge of a logic signal. These are identified by a little black triangle.

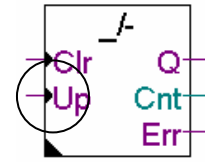

For example, a pulse counter cannot be incremented when its *UP* input is one.

Fbox: Counter, Up with clear

Otherwise, what would happen if the *UP* signal remained at one for any amount of time? The counter would be continuously incrementing itself for as long as the *UP* signal remained one. It is for this type of application that certain digital inputs have been dynamized. Therefore, only the positive edge of a *UP* signal will increment the counter.

It is sometimes necessary to add dynamization to the input or output of an FBox. We then use the *Binary, Dynamize* function



4.7.6 Comments

Comments can be inserted with the program:

1. Select the *Place comment* button
2. Position the comment on the program page, then press the left mouse button.
3. Write the comment.
4. Press the *ENTER* button.



4.7.7 FBox Help

To obtain a full description of any function, select the FBox in the *FBox Selector* and then press the F1 key.

Another solution would be to position the mouse pointer on an FBox in the program and double-click on the left mouse button.

For rapid identification of an unknown FBox found in a program, call up the *FBox Selector* window, position the mouse pointer on the unknown FBox and single-click on the left mouse button. The *FBox Selector* window will then display the function selected in the program.

4.8 Links between FBoxes and connectors

4.8.1 Link by shifting FBox

1. Click on the *Select Mode* button on the toolbar.
2. Point onto the FBox, then press the left mouse button.
3. Keep pressing the mouse button as you drag the FBox towards a neighbouring FBox.
4. The FBoxes are linked as soon as the two connections touch.

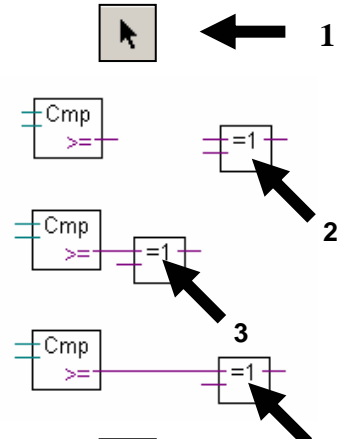

4.8.2 Link with automatic routing

1. Click on the *Auto Line Mode* button on the toolbar.
2. Position the mouse pointer at the depart and click on the left mouse button.
3. Position mouse pointer on destination point and click the left-hand mouse button.

Note:

Intermediate points of passage can also be selected.

To interrupt link editing, press the right-hand mouse button.

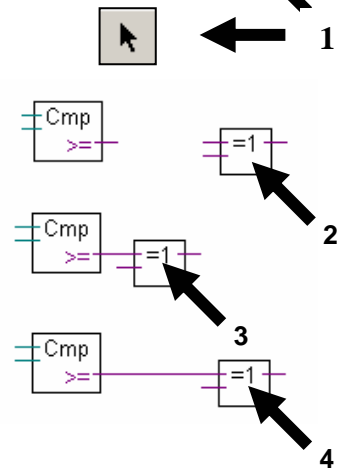

4.8.3 Multiple link with automatic routing

1. Select menu *Mode, Connect Bus* or (CTRL+B).
2. Select a starting point with the mouse.
3. Then select the destination point

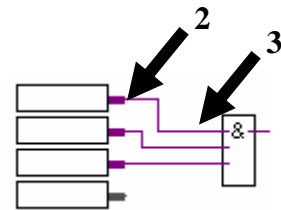

4.8.4 Link all inputs/outputs on an FBox to connectors

Place the mouse pointer over an FBox. Right-click to display the context menu: *Connections, Connect All*.

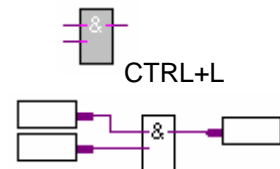

4.8.5 Delete lines, FBoxes, connectors or symbols

Select the *Delete Mode* button on the toolbar, then select the links, FBoxes or symbols to delete.



Another, faster solution is to mark a space and delete it.

- 1 Press the mouse button.
- 2 Without releasing the button, drag the mouse.
- 3 Release the mouse button.
- 4 Select menu *Edit, Delete*

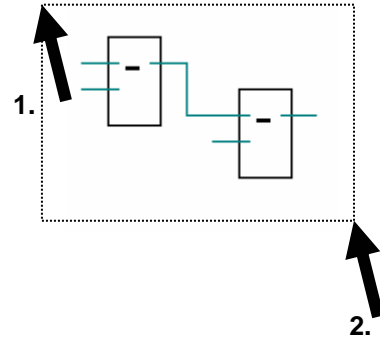

4.8.6 Move FBox/connector vertically without undoing links

Position the mouse pointer over the FBox.
 Press and hold down the shift-key.
 Press and hold down the left-hand mouse button.
 Drag the mouse vertically onto a free area on the page.
 Release mouse button and shift-key.

To move the connector, position the mouse pointer in the red circle and repeat the sequence.

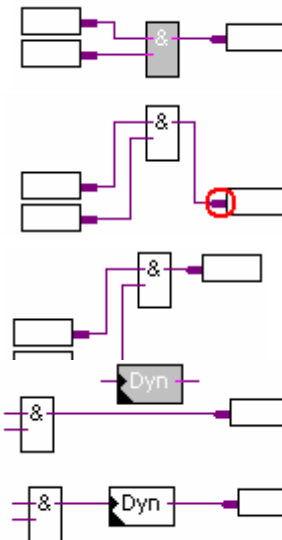

4.8.7 Insert FBox without undoing link

Select the FBox to insert in the *FBox Selector*.
 Place it above the link.

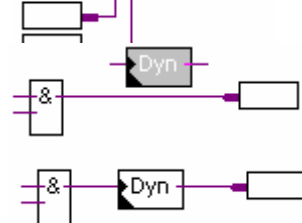

4.8.8 Rules to follow

Loops are not allowed. If a loop is created, an error message will be displayed: *Page 1: Error 55: Loop back detected*

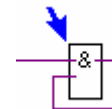

No direct links are allowed between input connectors and outputs connectors. An FBox must be used: *Binary, Direct transfer* or *Integer, Direct transfer*.



Output connector symbols must always be linked to an FBox. If not, an error message will be displayed: *Page 1: Error 53: Incomplete network*



4.9 Editing Fupla pages

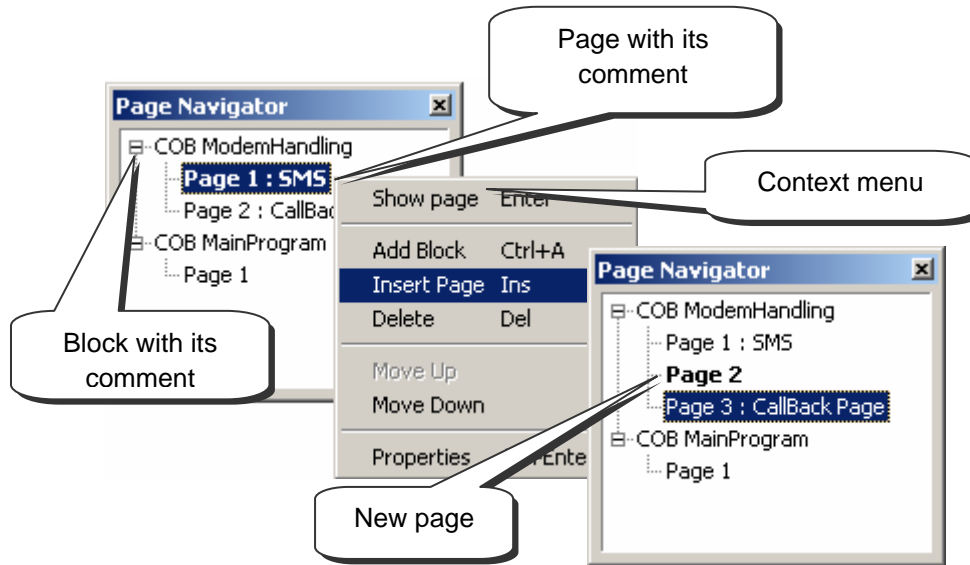

Show/Hide
Page Navigator

The *Page Navigator* window shows the program's blocks and pages. Each Fupla file can hold up to 200 pages grouped into blocks: COBs, PBs, FBs, or SBs. But Fupla is faster if you don't have too many pages in a single file. By default, pages are put into a COB type block. For more detailed information about blocks and their use, please refer to chapter 5 of this document.

4.9.1 Insert page



Insert Page

Open the *Page Navigator* window, mark the reference page and select *Insert Page* from the context menu.

It is also possible to insert a page after the current page with the *Insert* button or the menu item: *Page Insert After (Page Insert Before)*

4.9.2 Delete a page

Open the *Page Navigator* window, mark the page to be deleted and select *Delete* from the context menu.

4.9.3 Page navigation



Goto Next
Page

It is also possible to navigate with the *Go to Previous Page* and *Go to Next Page* buttons, allowing movement from page to page in a Fupla block. If either of the buttons is grey, you are already on the first or last page of the block.

4.9.4 Page documentation

You are strongly advised to document each of your Fupla pages. This is very useful when navigating through the pages of your program, because page names and comments will be displayed in the *Page Navigator* window. The description is a way of leaving some useful information about the program that will make it easier to maintain.

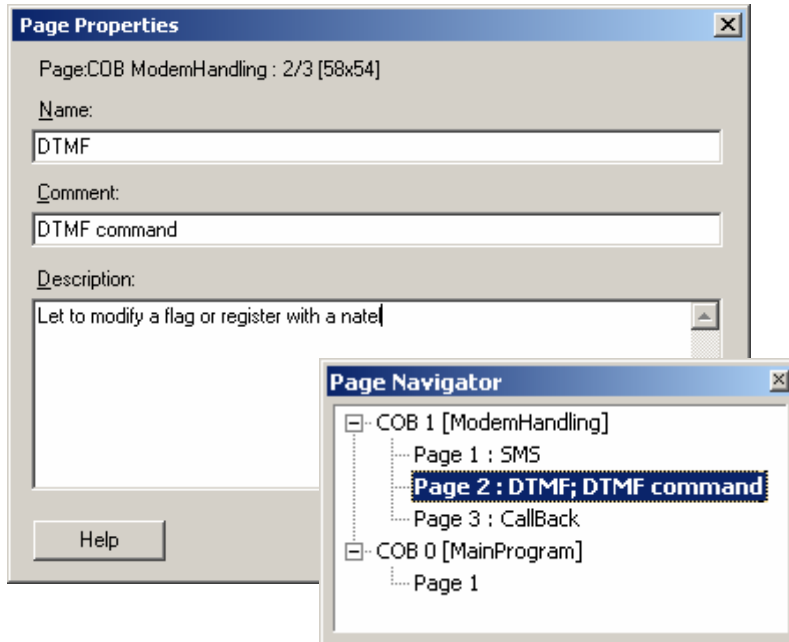

4.9.5 Processing of program by the PCD

The PCD processes the pages of each block from the top left of the first page to the bottom right of the last page. For more precise details on the order in which FBoxes are processed by the PCD, select menu path: *Page, FBox Priorities*

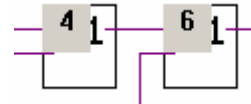

4.10 Copy and paste

Certain parts of a program may be repetitive. It is not necessary to edit them again in full. It is much faster to duplicate them by copying and pasting, and then adapt them as required.

4.10.1 Copy/paste part of a program

1. Click on the Select Mode button.
2. Mark the area to be copied:
 - Press the left mouse button.
 - With button still pressed, slide mouse.
 - Release left mouse button.
3. Add an FBox or connection to the selection:
 - Press the *Ctrl* key.
 - Keeping the *Ctrl* key down, select the connectors and FBoxes to add.
4. Copy the selection with the *Edit Copy* menu path, or with the *Ctrl+C* keys.
5. Paste a copy of the selection with the *Edit Paste* menu path, or the *Ctrl+V* keys.
6. Position the copy on the Fupla page:
 - Position mouse pointer in middle of copy.
 - Press left mouse button.
 - With button still pressed, slide mouse.

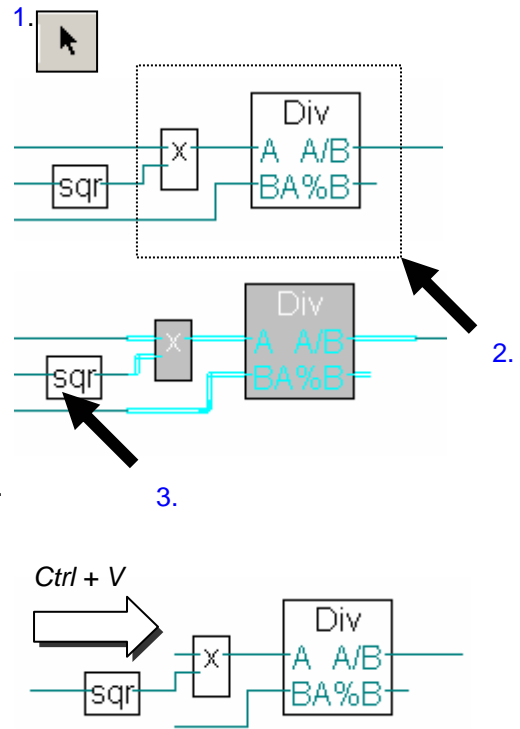

4.10.2 Copy and paste symbols

1. Click on the *Select Mode* button.
2. Mark a list of symbols:
 - Position mouse pointer on first symbol.
 - Left-click with mouse.
 - Position mouse pointer on last symbol.
 - Press *Shift* key. *)
 - Keeping *Shift* key down, left-click with mouse.
3. Copy the selection with the *Edit Copy* menu path, or with the *Ctrl+C* keys.
4. Position the mouse pointer on a free part of the margin.
5. Paste a copy of the selection using the *Edit Paste* menu path or the *Ctrl+V* keys..

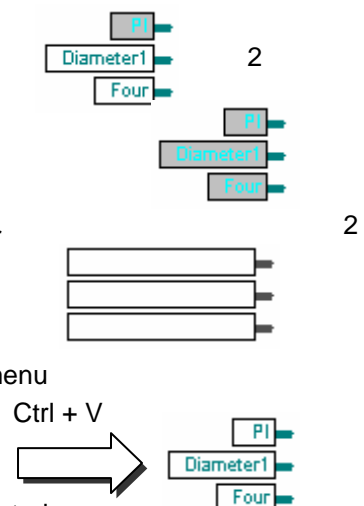

*) The *Ctrl* key allows non-consecutive symbols to be selected.

4.11 Page export and page import

Page export/import is a complementary tool to the copy/paste function, but much more powerful. It offers the following advantages:

- Copying and pasting several pages
- Modification of imported symbols and addresses
- Possibility of creating a component library

4.11.1 Page export

Page export can be used to select one or more pages from a Fupla program and save them in a file – along with FBoxes, connections, comments and symbols. In this way, parts of programs currently used in one or more files (*.fxp) can be brought together to form a component library that can be used to build future applications more quickly.

For example, let us assume you often use daily, weekly and monthly timers to switch a digital output on or off at a specific time in any day, week or month. You therefore create a program of several pages, in which each page corresponds to one of the timers currently used, and export the lot to a file: *Timer.fxp*.

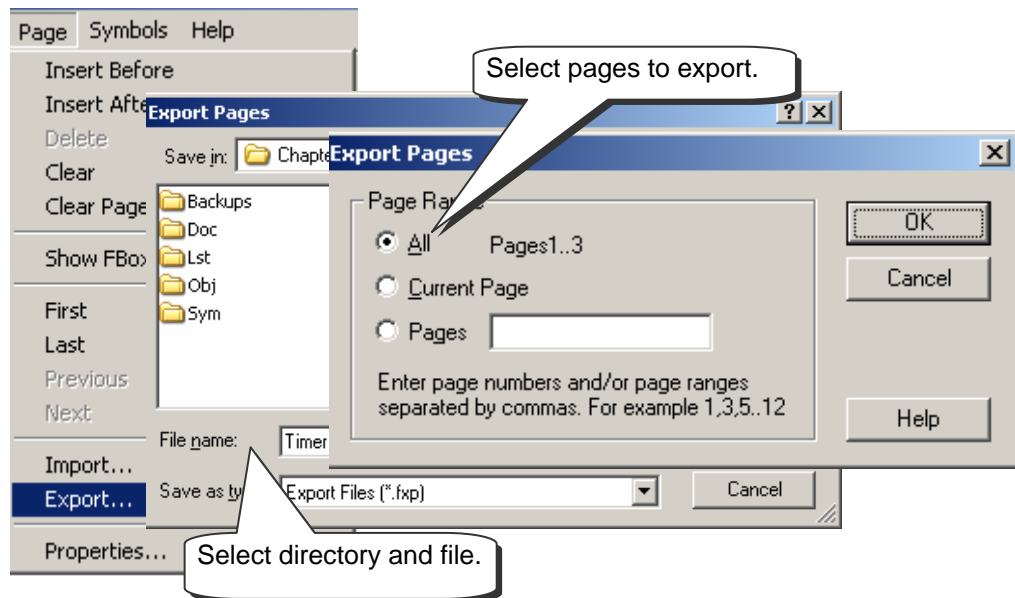

4.11.2 Page import

Page import supports the selection of one or more pages from a file (*.fxp) and the editing of symbols imported to the Fupla program.

The *Page Range* list allows the selection of page(s) to be imported.

To return to our example, each time you need a timer, you import the file *Timer.fxp* and select the page(s) that correspond to the component required for your application.

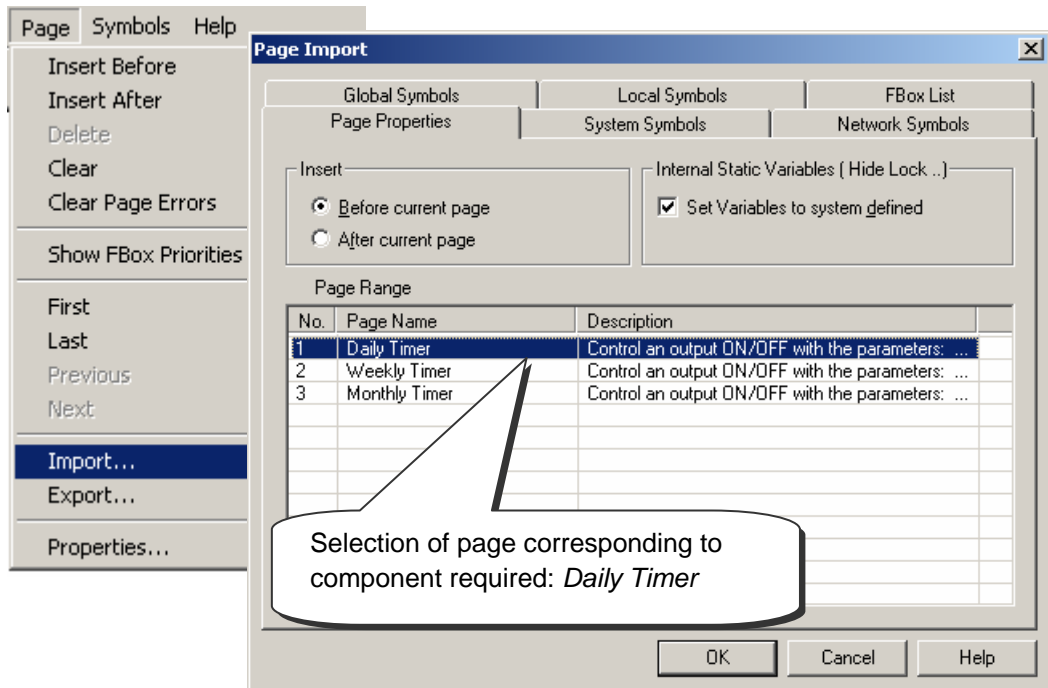

The *Global Symbols* and *Local Symbols* windows display a list of symbols that correspond to the selected pages. It is even possible to modify the name and value of each symbol.

Marking the symbols and putting them in a group is the fastest way to change the names of all symbols in an imported program.

The context menu *Insert Pre-group* allows the symbols selected to be put in a group with the name of your choice.

Marking all the symbols and renumbering them is also a fast way of changing the addresses of symbols in imported pages.

The context menu item *Renumber* allows the addresses of selected symbols to be changed, either using an address offset or from a base address.

The *FBox List* displays lists of symbols linked to a group of FBoxes. These symbols give access to internal FBox information, such as the addresses of adjust window parameters. This list allows modification of names that are attached to FBoxes from imported pages.

Returning to our little example, we propose importing symbols from the daily timer component into a *Heating* group. For each new daily timer, define a different group name. In this way, component symbols that are used more than once will belong to different groups and will not give rise to any addressing problems when the program is built.

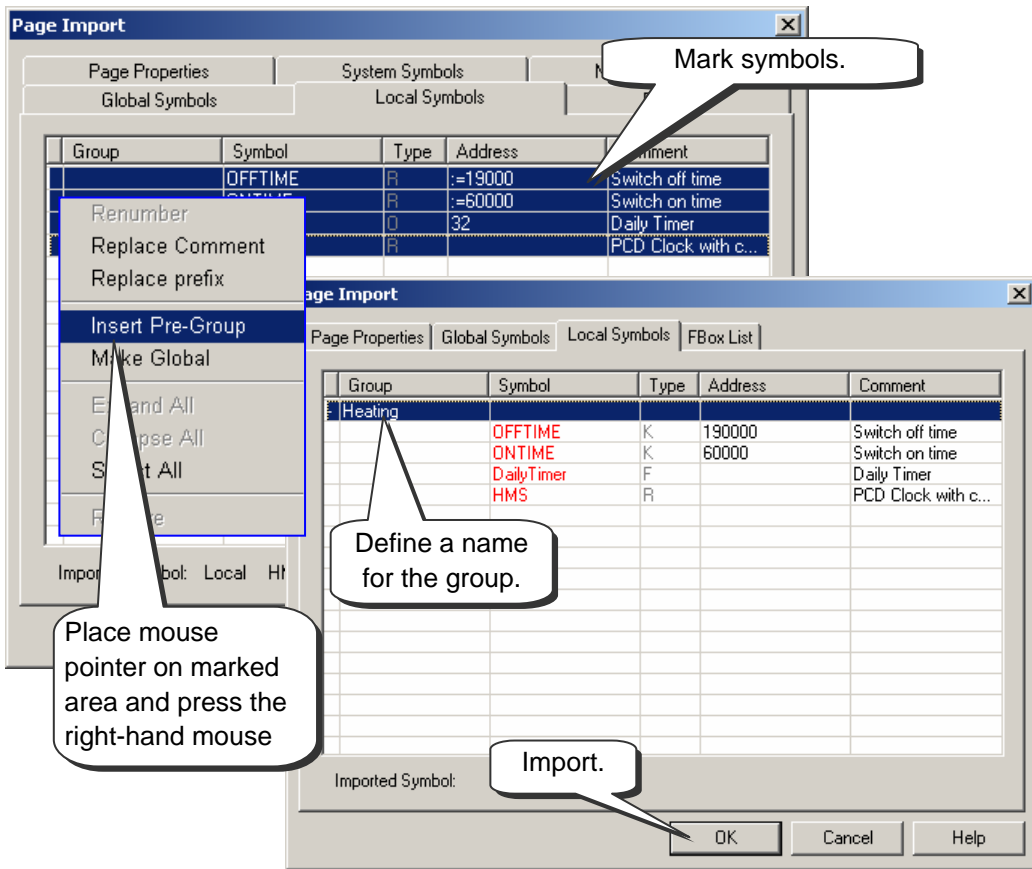

Component imported with its new symbols

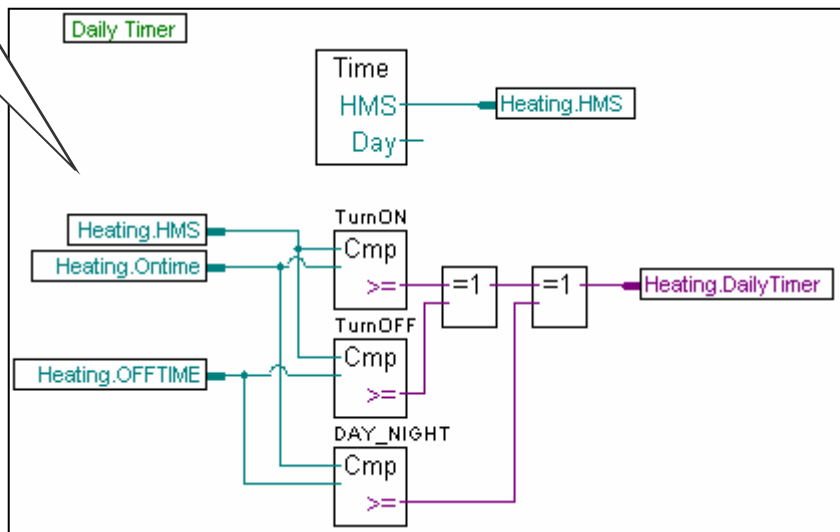

4.12 Editing a first Fupla program

4.12.1 Objective

Now that the working environment is known, the next step is to create a more complex program than the logic structures presented up to this point. We propose creating a daily timer to control a digital output (O 32) that comes on at 06.00 hrs and goes off at 19.00 hrs. Although this function is available with the HEAVAC library, we are going to reproduce it ourselves using standard FBoxes.

4.12.2 Method

Before starting to program, a method must be found that will behave according to our specification document and that can be implemented with the most elementary functions possible.

For this timer example, we propose making two comparisons. The first will determine whether the current time in *HMS* (i.e. the time by our watches or PCD time) is greater than or equal to the turn-on time: *ONTIME*. The second will determine whether current time is smaller than or equal to the turn-off time: *OFFTIME*. If both comparisons are verified by an expression – an exclusive OR logic function – the timer's digital output 32 *DailyTimer* must be switched on.

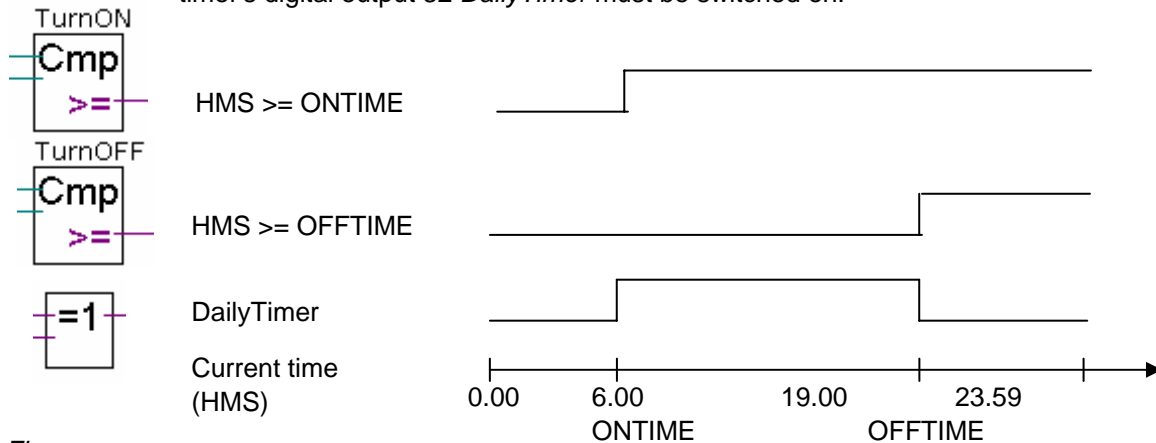

Fbox :

- Integer, Is greater or equal to
- Binary, Xor

This algorithm offers one solution, but it may leave some gaps. What happens if the turn-on and turn-off time instructions overlap? The following drawing demonstrates that the PCD output will be in the opposite state to that desired.

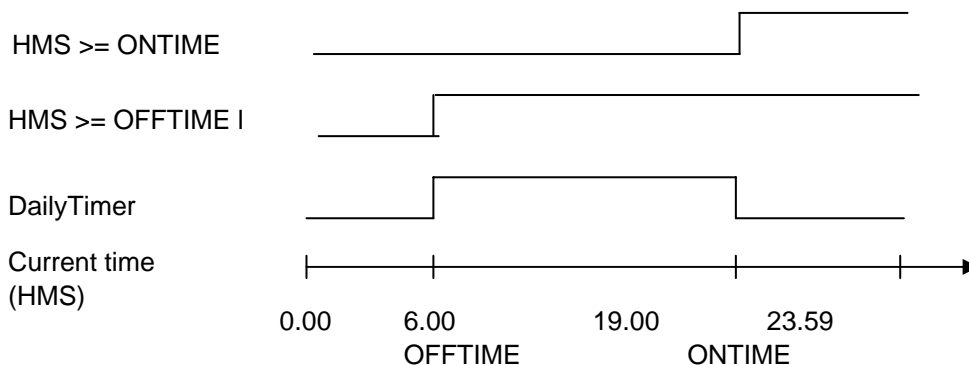

It is therefore necessary to complete our algorithm by adding a third comparison to determine whether the turn-on time is greater than or equal to the turn-off time. The final solution is therefore as follows.

Outputs active by day:

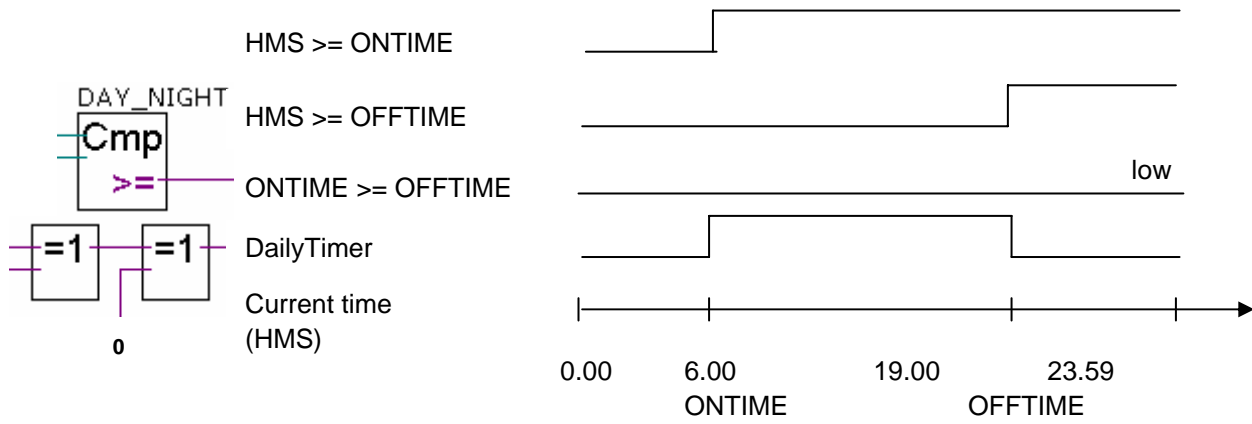

Outputs active by night:

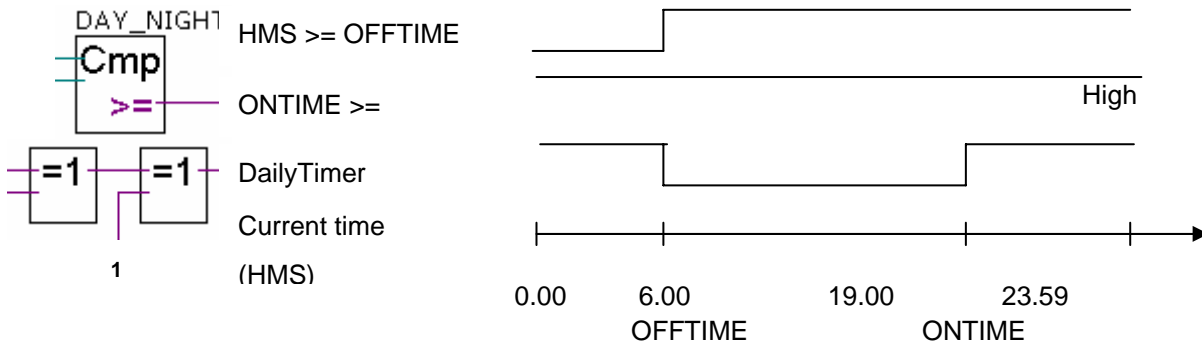

4.12.3 Programming

It is now time to move on to programming. At the beginning of this chapter we created a project with a file in it called: *DailyTimer.fup*. This is the file to which you will now write the present programming example.

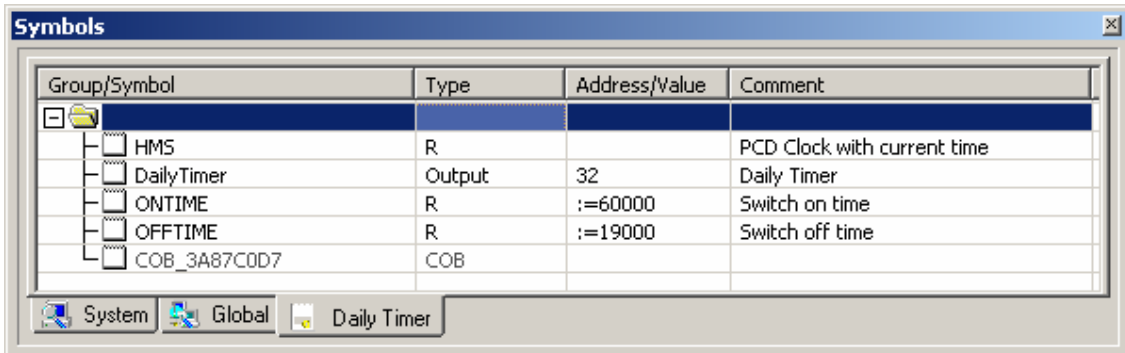

Start by creating the symbol list. Note that the current PCD time is saved in a dynamic HMS register. The address of this register has not been defined. The PG5 will automatically assign its address when the program is built.

The same applies for the turn-on and turn-off times (*ONTIME*, *OFFTIME*), except that «:=60000» is not a register address, but the value with which it will be initialised when the program is downloaded to the PCD (:=60000 means 6 hours 00 minutes 00 seconds).

N.B.: A PCD coldstart will not reinitialise these registers. They can only be reinitialised by downloading the program!

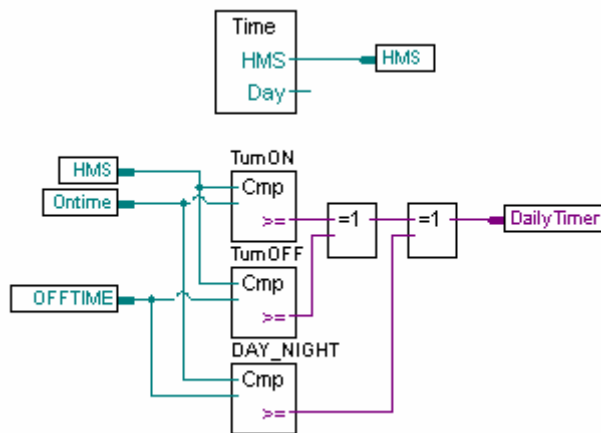

All the necessary FBoxes can be found in the *Standard* group of the *FBox Selector* window:

- Time related, Read time
- Integer, Is greater or equal to
- Binary, Xor

4.13 Building the program



Before the fully edited program can be read and executed by the PCD, it must be “built” (or converted) using the CPU Build menu command or the Build button.

Build All

The Message window shows the results of various stages of the program build (Compiling, Assembling, Linking etc.). If the program has been correctly edited, the build function concludes with the message: Build successful. *Total errors 0 Total warnings: 0*

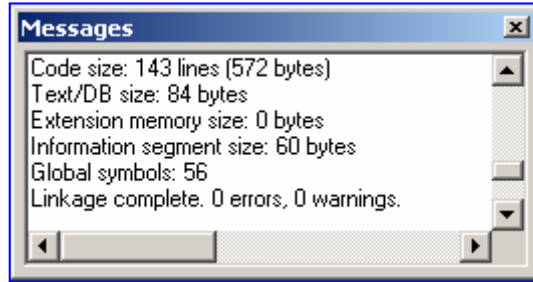

Any errors that arise are indicated with a red message. By double-clicking the mouse button, the error can easily be located in the user program.

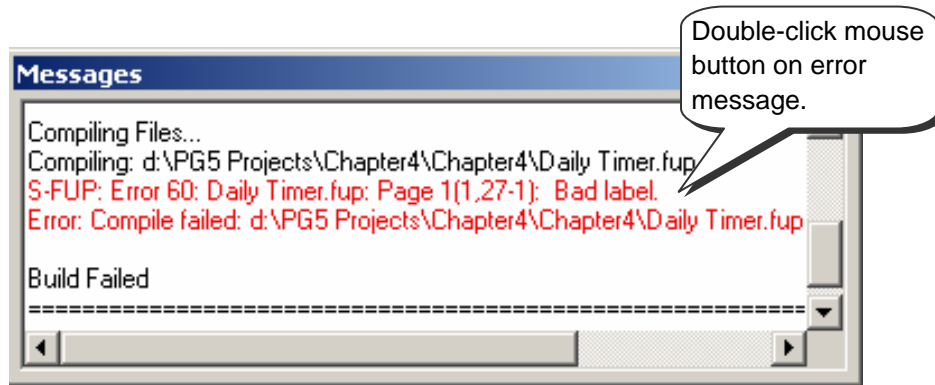

Error marked in red or indicated with an arrow

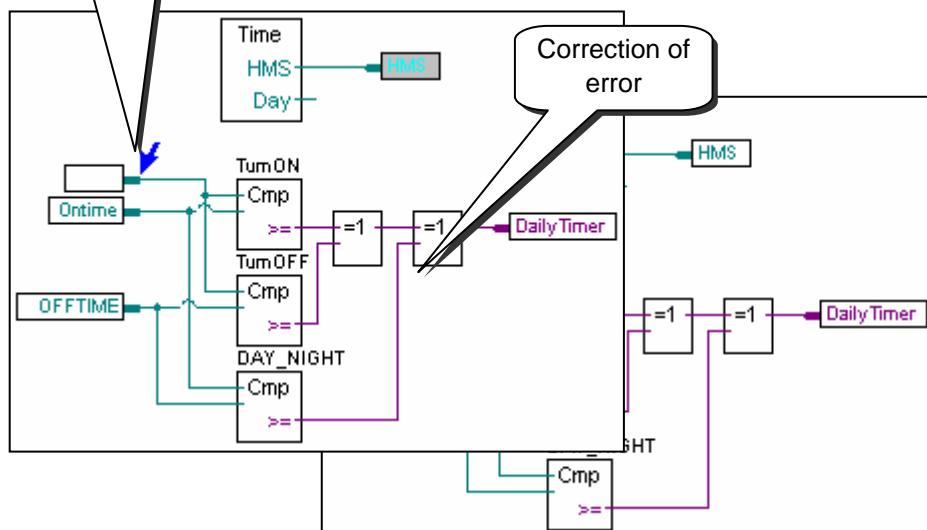

4.14 Downloading the program into the PCD



The user program is now ready. All that remains is to download it from the PC into the PCD. This is done with the Download Program button or via the SAIA Project Manager window, Online menu, Download Program.

Download Program

If any communications problems arise, check the configuration settings (Settings Online and Settings Hardware) and the PCD8.K111 cable connection between PC and PCD (PCD8.K111, USB).

4.15 Finding and correcting errors (Debug)

The first version of a program is not always perfect. A stringent test is always needed. The program test is supported by the same program editor that was used to write the program.

4.15.1 Go On/Offline – Run – Stop - Step-by-step

1. Press the *Go On /Offline* button
2. Start program with the *Run* button

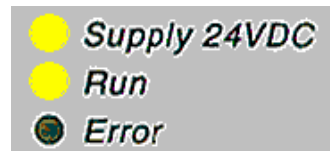

Parallèlement, observer la lampe *RUN* placée sur la face avant du PCD. A la sélection du bouton Run, la lampe *RUN* est allumée, le PCD exécute le programme utilisateur.

3. When the *Stop* button is selected, the *RUN* lamp goes off and the PCD stops execution of the user program.
4. The PCD executes one FBox each time the *Step-by-step* button or *F11* key is selected.



Observe the Stop marker which indicates the step-by-step progress of the program.

4.15.2 Breakpoints

Breakpoints let you stop a program at an event linked to one of its FBoxes, or to a symbol:

State low or high of input, output, flag or status flag

Value present in register or counter

Breakpoint on a symbol

The stop condition can be defined via the menu *Online Breakpoints*.

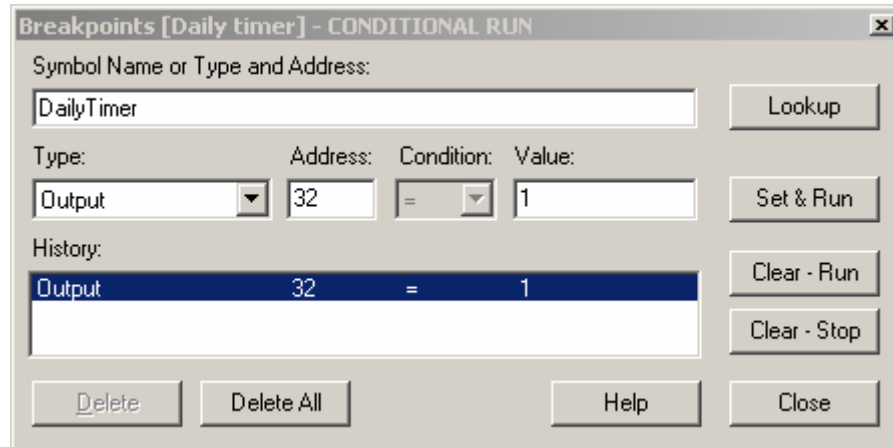

The above window is used to define symbol type and address/number. A symbol can simply be dragged from the symbol editor into the *Symbol Name* field, then the breakpoint condition and status/value are defined.

Pressing the *Set & Run* button will force the PCD into conditional Run mode. The PCD's *Run* LED will flash and its *Run* button will alternate between green and red.

The PCD will automatically put itself in stop mode when the breakpoint condition is reached. For example, when an instruction modifies the output value, the status of 32 is high. The last FBox processed by the PCD is shown in red. It is possible to continue processing the program in step-by-step mode, or with another breakpoint condition.

If necessary, conditional Run mode can be interrupted:

The *Clear-Run* button forces the PCD into RUN mode. The PCD's *Run* LED will come on the its *Run* button will be green.

The *Clear-Stop* button forces the PCD into Stop mode. The PCD's *Run* LED will go out and its *Run* button will be red.

If a number of conditional breakpoints are defined, they will all be recorded in the *History* field. Any of them can then be selected with the mouse and activated with the *Set & Run* button.

Breakpoint on a program FBox

Select any FBox within the program, followed by the menu *Online, Run to, Fbox*, to make the program stop at the chosen FBox, and then continue in step-by-step mode.

4.15.3 Display symbols or addresses

The *Show Operand as symbol* or *value* button allows information from the connectors to be displayed with their symbols or addresses. If pressing it does not replace a symbol with its corresponding address, that symbol's address is assigned by the build.

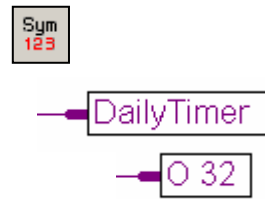

4.15.4 Display symbol state with Fupla

When the editor is Online and the PCD is in *RUN* mode, each individual symbol used by the program can be displayed:



Place Probe

The logical state of binary information is shown with a heavy or fine line (heavy = 1 and fine = 0)
 All other information can be displayed by clicking the left-hand mouse button on the connection desired.

Double-clicking on a probe opens the *Probe Display Format* window, allowing a choice of format for values consulted: integer, hexadecimal, binary, floating point, boolean or ASCII.

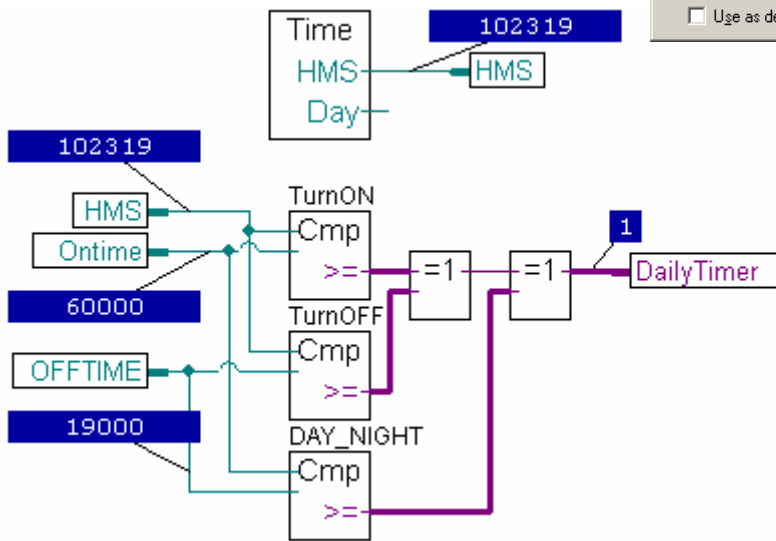
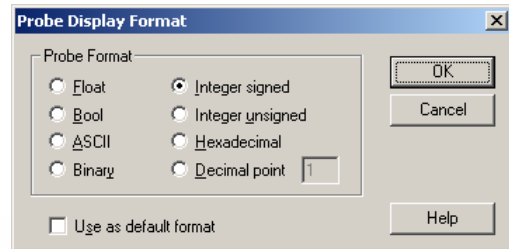

4.15.5 Edit symbols online

When checking program behaviour under certain conditions of use, it is sometimes helpful to change the states/values of symbols present in the input connectors.

Select an input connector with the mouse and right-click to display the context menu. The *Edit Data* context menu lets you modify the state/value of a symbol inside a connector.

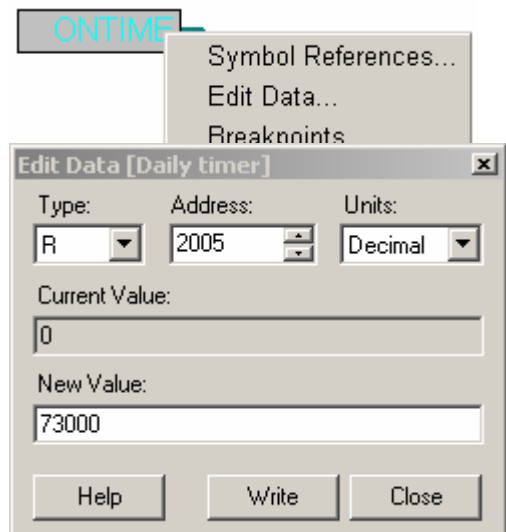

4.15.6 Display symbol state with *Watch window*

Another useful way to test and display the symbol states in our example is in the *Watch Window*. Press the *Watch Window* button. Then drag symbols from the symbol editor to the *Watch Window*:

1. Place mouse pointer in centre of symbol icon. Press left mouse button.

2. Keep mouse button depressed and drag symbol into watch window.

3. Symbols with their comments and states

4. Start/Stop Monitoring

To test the proper functioning of our daily clock example, we will now modify the turn-on/off instructions (*ONTIME* and *OFFTIME*) and observe the state of the *DailyTimer* output. To edit an instruction, proceed as follows:

1. Start/Stop Monitoring

2. Place mouse pointer on value to edit. Double-click on the left mouse button and edit the new value.

3. Download Values

Symbol	Address	Value	Modify Value	Symbol Comment
HMS	R 2113	104852		PCD Clock with current time
DailyTimer	O 32	1		Daily Timer
Ontime	R 2115	60000	43000	Switch on time
OFFTIME	R 2114			Switch off time

4.15.7 Setting the PCD clock

When a PLC is commissioned, its internal clock is not always at the correct time. To adjust it, proceed as follows:

1. Select the *Online Configurator* button on the *Project Manager* window. Then select *Clock*.



2. Copy the time from the PC to the PLC with the *Copy to PCD >>>* button, or adjust clock settings in the *SAIA PCD Clock* fields.

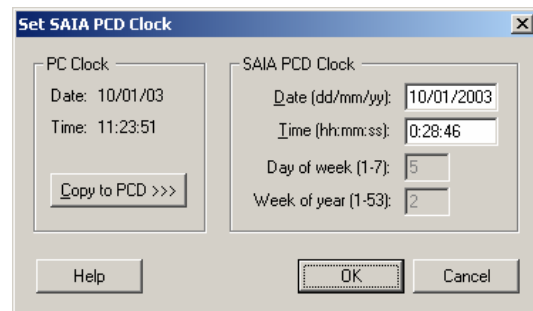

4.16 Adjust windows

Some FBoxes, identified by a black triangle in one corner, sit a number of adjustable parameters. These adjustable parameters are used with the HEAVAC library, and also with other FBox libraries.

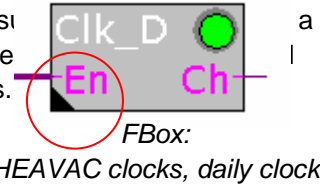

Parameters in the adjust windows define variables in the same way as input links, but with additional benefits such as: individual parameter descriptions, on-line correction, simplicity of use, etc. To display the adjust window, double-click with the left-hand mouse button on any FBox that has a black triangle.

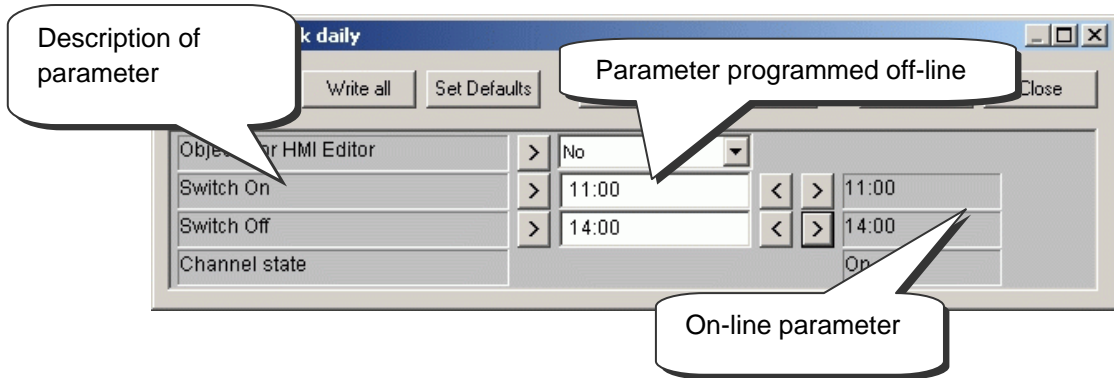

The adjust window has three columns :

Adjust parameter description column. Describes the use of the parameter. Additional information is available if the description ends with three dots - double-click on the text with the left-hand mouse button.

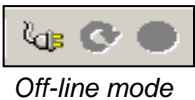

Off-line mode

Off-line parameter value column. This value was defined when the application was programmed. It has been saved in the Fupla file. The parameter can be defined generally in the form of an integer, a multiple-choice selection, or sometimes with a button. With some parameters, the value can also be edited when the PCD is on-line.



On-line mode

On-line value column. This column displays the information saved in PCD memory (register or flag). It is the data used by the PCD program when it is in *Run* mode.

4.16.1 Types of adjust parameter

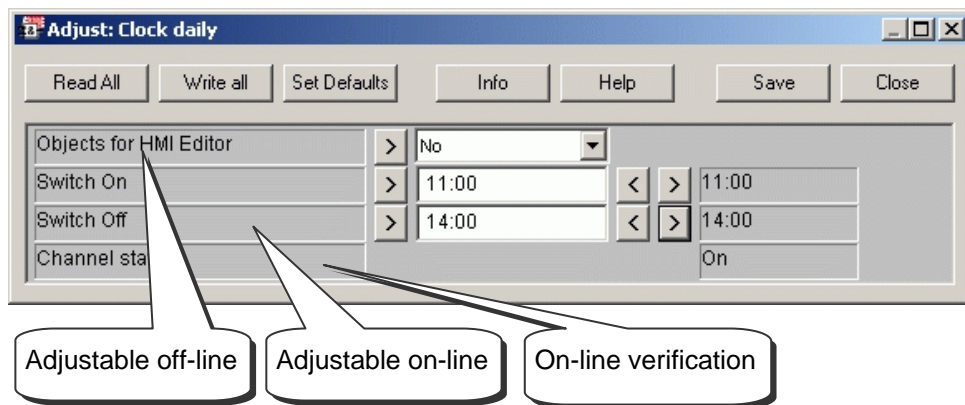

Adjust parameters can be divided into three main groups.

Off-line adjustable parameters

Each off-line modification of a parameter requires a *Build All* and a *Download Program* before the PCD program will take it into account.

On-line adjustable parameters

On-line modification of a parameter does not require any *Build All* or *Download Program* before it will be taken into account by the PCD program. The parameter is adjusted directly in PCD memory.

On-line verification parameters

These parameters are not intended for modification. They are displayed for information and to verify the proper functioning of a program or FBox.

4.16.2 Initialization of HEAVAC FBox

When using certain FBox libraries, such as the HEAVAC applications, an initialization FBox must always be positioned at the start of the Fupla file. It allows some of the library's common tasks to be managed, such as initialisation of the library after the program has been downloaded or after a PCD coldstart (PCD power-up).

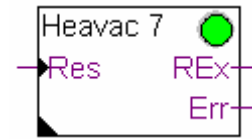

Fbox: CVC Init, Initialization CVC 7

After any program download and PCD coldstart, the *Res* input of this FBox and the adjust parameters shown below have an important influence on initialisation of the adjust parameters for all the other HEAVAC FBoxes in the program.



Downloading the program and the automatic Reset parameter:

With the Active option, the adjust parameters of all HEAVAC FBoxes will be initialised with the values defined by the program.

With the Not active option, all existing parameters in the PCD will be preserved.

Res input and the Evaluate Reset input parameter:

If the status of the reset input is high, the adjust parameters of all HEAVAC FBoxes will be initialised with values defined during programming.

Depending on the option selected for the Evaluate Reset input parameter, the Res input will only be taken into account in case of a PCD coldstart or during runtime (always).

Green/red LED

Some FBoxes have a simulated LED that can display three different colours: grey when the controller is off-line, green or red when the controller is on-line. Green signifies that everything is functioning properly, red indicates an error (generally caused by information at FBox inputs or by the selection of unsuitable adjust parameters. For more detailed information, please consult the guides regarding FBox errors).

N.B.:

Within the HEAVAC library you will find different versions of the initialisation function (Initialisation HEAVAC 4, ...7). Version 7 is the most recent. We recommend the use of function 6 for all new applications.

4.16.3 HEAVAC FBox with adjust parameters

The *CIK_D* FBox allows a daily clock to be produced just like in this chapter, but with a single FBox available in the HEAVAC library. The FBox output can be switched on or off according to time window.



FBox: HEAVAC clocks, Daily clock

The parameter *Objet pour HMI editor* is only used in the presence of HMI terminals. If this option is not used, keep the proposed standard parameter. Input *En* allows the clock function to be disabled. If *En* is low, output *Ch* will remain inactive.

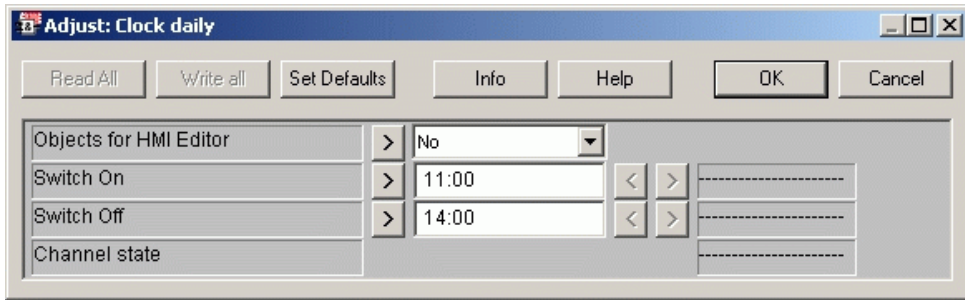

4.16.4 Mini HEAVAC application

To try out the operation of adjust window parameters we can once again use the daily clock program presented at the beginning of this chapter. However, this time we will achieve it with the help of the HEAVAC library.

The two FBoxes described above are the only ones we need. Create the program as set out below, then execute *Build All*, *Download Program* and *Go Online*.



Rebuild All



Download Program



Go Online

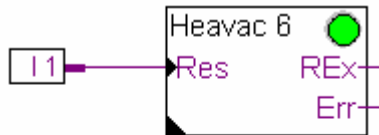

If the program is extended with several other HEAVAC FBoxes, the *Initialisation HEAVAC 7* FBox must be positioned once only at the top of the first Fupla page.

4.16.5 Parameters after download program

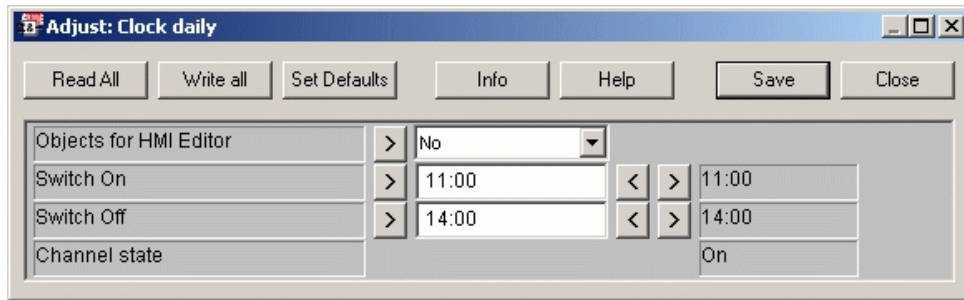

The middle column shows switch-on and switch-off parameters for the daily clock as defined during programming.

As a general rule¹, these will be the same parameters used in the PCD and displayed in the right-hand column. (switch-on/switch-off parameters and state of output Ch)

4.16.6 Writing parameters on-line

During on-line testing, it is possible to edit new switch-on and switch-off parameter values for the FBox output channel:

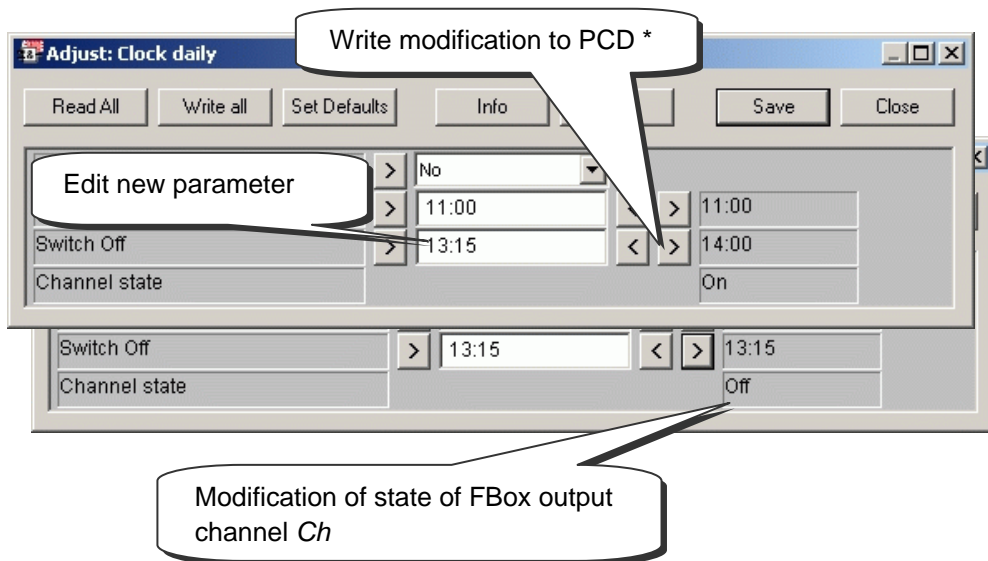

* It is also possible to write all adjust window parameters by selecting the *Write All* button.

If the corrected parameters are to be saved in the Fupla program for the next *Build All*, close the adjust window with the *Save* button, otherwise just use the *Close* button.

¹ This may be different depending on the options defined in the adjust window *Heavac 7* and the state of the *Res* input during a PCD coldstart.

4.16.7 Read on-line parameters

Sometimes the user may wish to read and save existing adjust parameters in the controller's memory for the next *Build All*. This operation with transfer parameters from the controller's memory to the Fupla file.

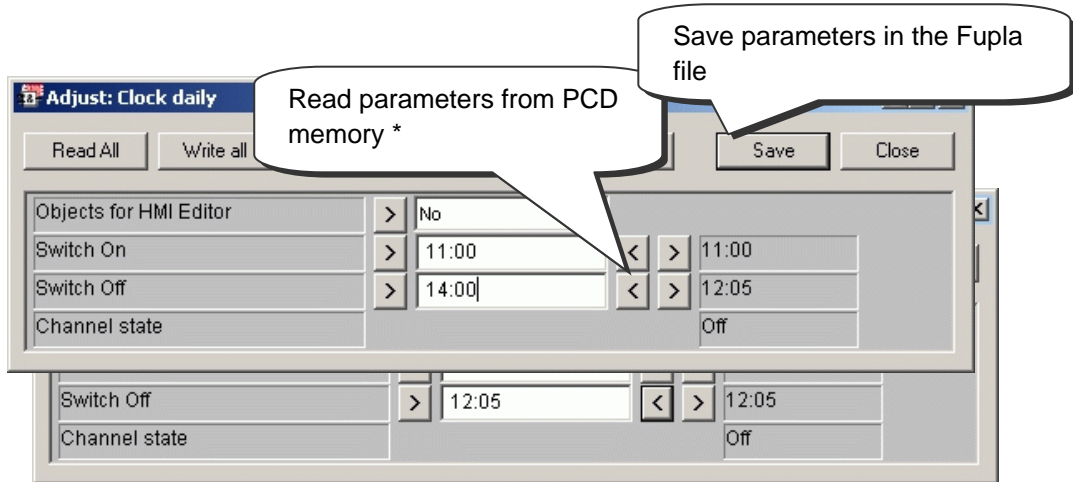

* It is also possible to read all adjust window parameters by pressing the *Read All* button.

* It is also possible to read all adjust parameters of all FBoxes in the Fupla file in PCD memory with the menu path: *Online, Read Fbox Adjust parameter*

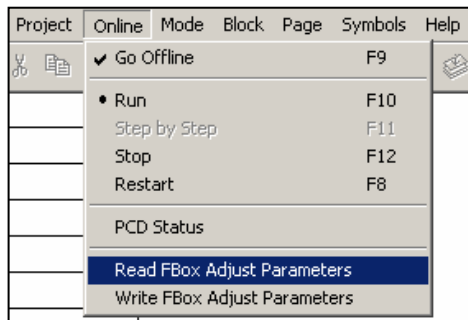

4.16.8 Restore default parameters

Even after numerous parameter modifications, it is still possible to restore the default parameters. These are the parameters as defined when the FBox was inserted in the Fupla page for the first time.

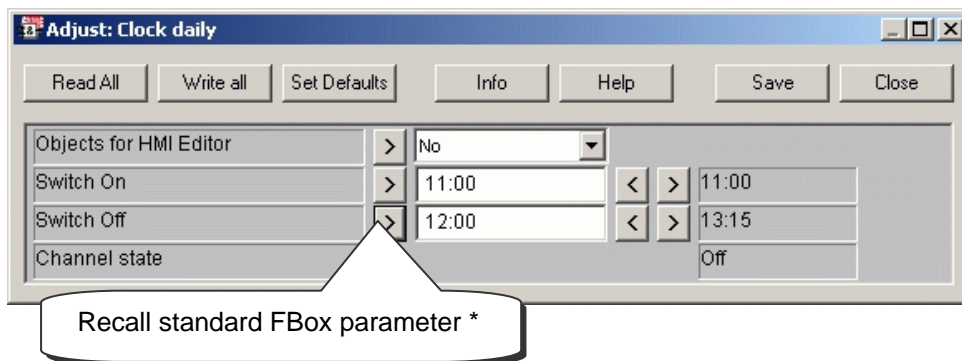

* It is also possible to restore all default adjust window parameters by selecting the *Set Defaults* button.

4.16.9 Define symbols for adjust parameters

Sometimes it is necessary to read or write adjust window parameters from the Fupla program, the communications network, or the supervisory system.

This is possible if symbols have been defined for flags or registers corresponding to parameters displayed in the FBox adjust window.

To define these symbols, right-click on the FBox to display the context menu. Select menu item *FBox Properties...* Define a symbol name for a group of parameters linked to the selected FBox.

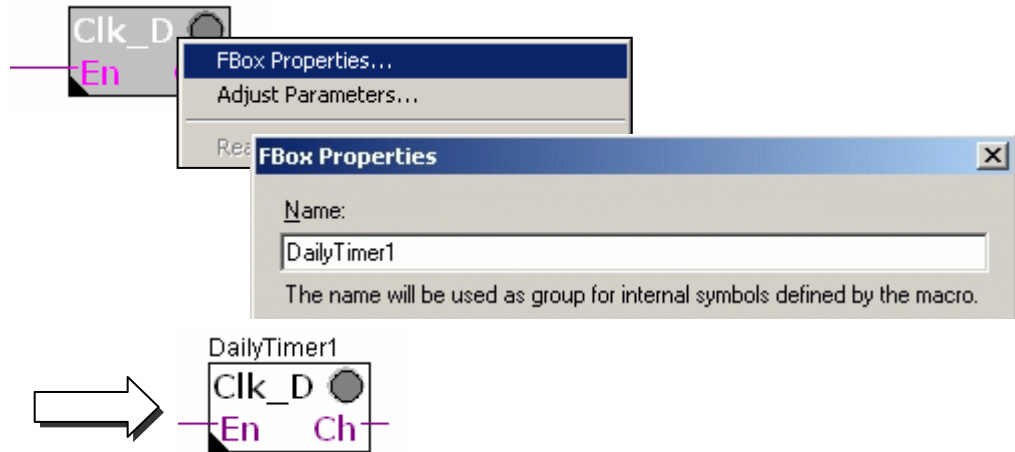

Build the program and open the symbol editor. A new *System* directory is now visible. It contains a list of the PCD's system symbols.

With the HEAVAC library, all system symbols corresponding to adjust window parameters are grouped under A.HVC.name (where name is the FBox name).

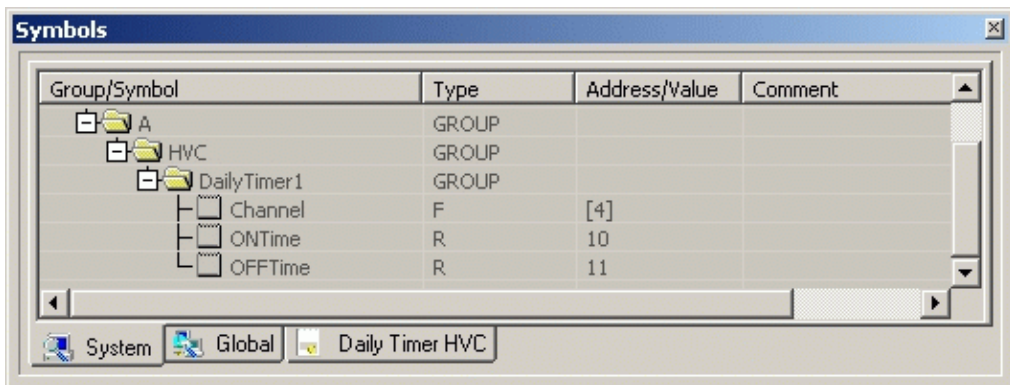

Now it is just a question of using these new symbols in the Fupla program.



4.16.10 Define adjust parameter addresses

Define adjust parameter symbol as described earlier and add address as follows:

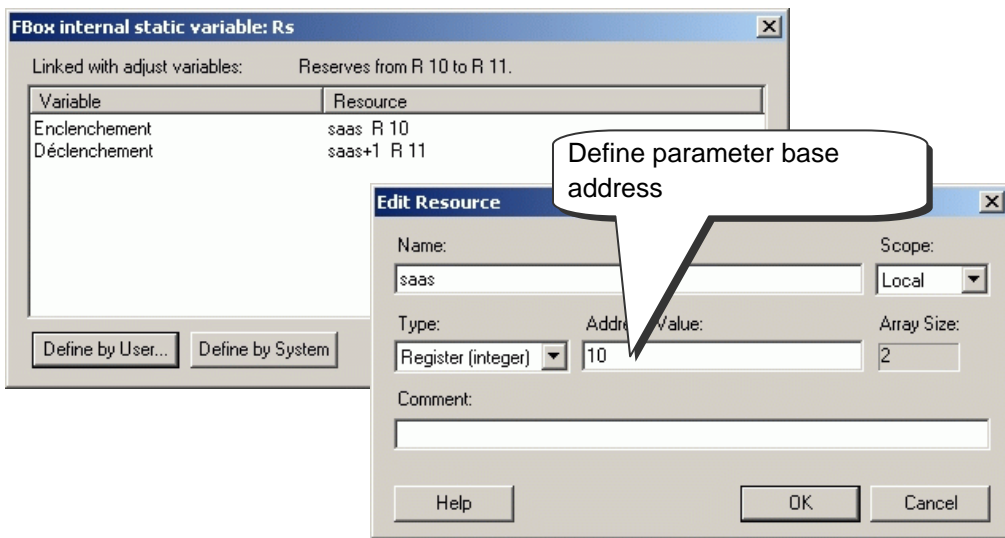
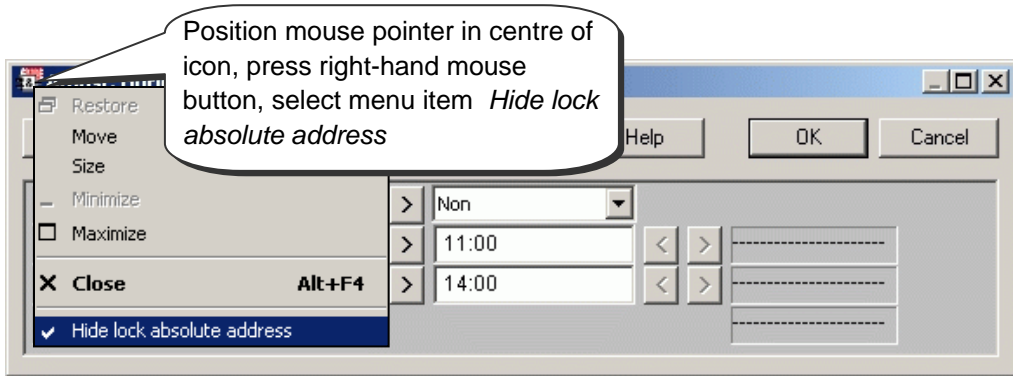

Build the program and open the symbol editor. System symbols have been assigned the register addresses shown below.



Rebuild All



Show/Hide Symbol Editor

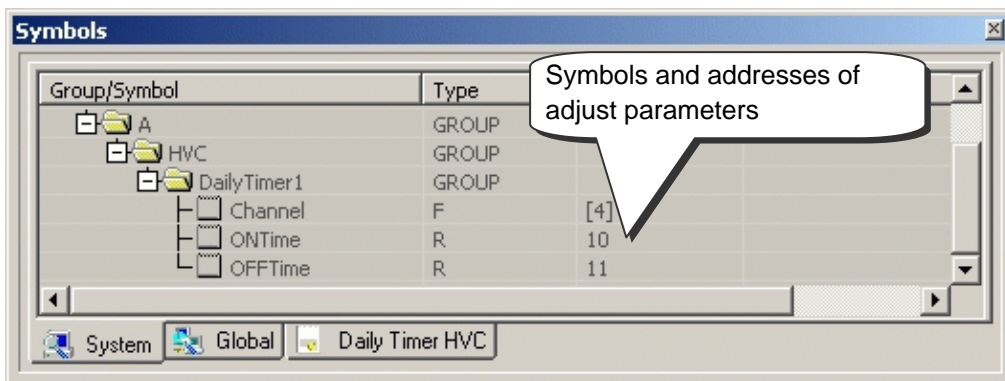

4.17 Commissioning an analogue module

4.17.1 Acquisition of an analogue measurement

The sample programs presented up until now make use of digital inputs and outputs, putting their addresses or symbols in the margin of the FUPLA editor.



With analogue input or output modules, an FBox must be used to acquire the analogue value. These FBoxes are available with libraries: *Standard*, *Analogue modules*, *Applications*, and *HEAVAC-Analogue*.

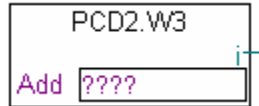

These libraries offer a wide variety of FBoxes, each corresponding to an analogue module. The name that appears in the *FBox Selector* matches the module item number.

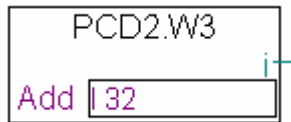

Analogue FBoxes are expandable. The user can define the number of measurement channels required by an application. If some measurement channels are not used, or if an extra channel is added, the context menu *Resize FBox* can be used to adjust its dimensions. However, an FBox can also be defined with the maximum number of channels, even if they are not all used.

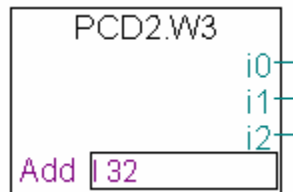

The *Add* field allows the base address of the analogue module to be defined. This address indicates where the module has been inserted in the PCD : 0, 16, 32, ...

Analogue measurements are available at FBox inputs I 0 to I 7. They can be connected directly to other FBoxes, or the values can be saved to a register. Saving a value to a register is a good solution, particularly when the value is used on several different pages of the program.

Attention:

Be careful never to define more than one FBox per analogue module, and never to insert the analogue module at the PCD watchdog address (255). Otherwise the value supplied by the module may be incorrect.

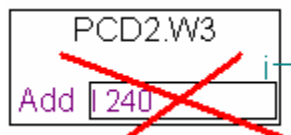

4.17.2 Example for PCD2.W340 analogue input modules

If the PCD is equipped with a PCD2.W340 module, which has 8 universal input channels, the user can take one of the following FUPLA FBoxes and define the required number of measurement channels.

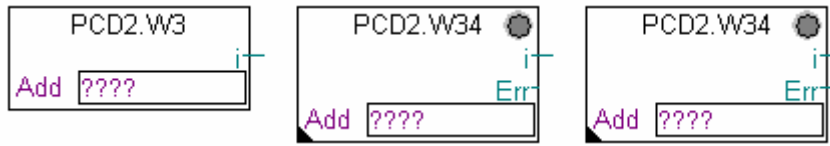

FBoxes: PCD2.W3, PCD2.W34, PCD2.W34 with error

Units of measurement depend on the module, FBox, and adjust parameters selected.

The PCD2.W340 is a universal module. It supports measurement of ranges 0..10V, 0..2.5V, 0..20 mA and Pt/Ni 1000 temperature sensors. A bridge must be selected on the module to define the measurement range. Resolution is 12 bits, equating to 4095 distinct measured states. (For more detailed information about these modules, please refer to your PCD hardware manual).

The *PCD2.W3* FBox supplies a raw measurement. For this module with a resolution of 12 bits, that corresponds to a measured value between 0 and 4095. The user then has the task of converting the measurement into a standard physical unit.

The *PCD2.W34* FBox is more elaborate. An adjust window allows units of measurement to be defined for each channel. The FBox LED turns red if one of the measurements exceeds the valid range: short-circuit or break in sensor cable. The error can be acknowledged with the *Acknowledge* button in the adjust window.

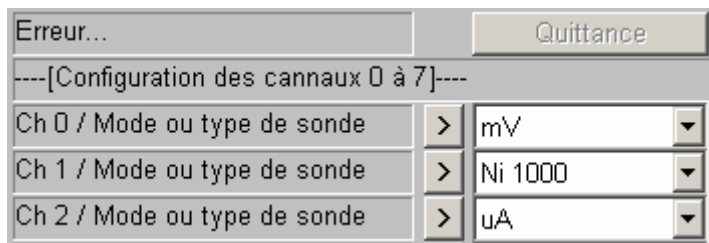

The *PCD2.W34 with error* FBox offers the same services for converting units, but also has an error output indicating which channel has the error, plus an additional adjust parameter to define a default value in case of error.

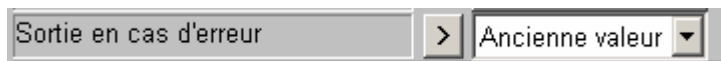

4.17.3 Example for PCD2.W610 analogue output modules

The same principle applies as for inputs: the user puts an FBox corresponding to the analogue output module on the FUPLA page, drags it to select the number of output channels and defines the module base address.

Unlike input FBoxes, the setpoints of analogue outputs are displayed on the left side of the FBox.

These inputs can be linked directly to other FBoxes, or to registers defined in the left margin of the FUPLA page.

If the PCD is equipped with a PCD2.W610 module, which has 4 universal analogue outputs, the FBox below may be used to output a current of 0...20 mA, or a voltage of 0...10 V.

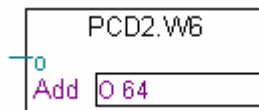

Fbox: PCD2.W6

A bridge must be selected on the module to define the output range. The resolution of this module is 12 bits, equating to 4095 distinct setpoint states. The integer value at the FBox input determines the output voltage or current of the channel:

Input value at Fbox	Output voltage [V]	Output current [mA]
0	0	0
2047	5	10
4095	10	20

Other FBoxes have an adjust window for adapting the range of setpoint values applied to the FBox input (e.g. the FBox for the PCD2.W605 module, which has 6 electrically isolated outputs of 0...10 V):

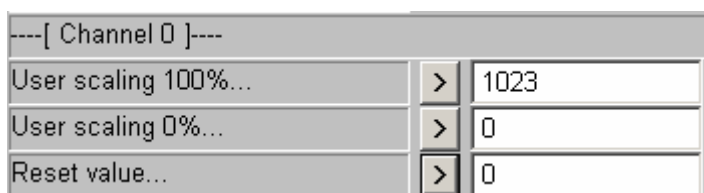

The parameters *User scaling 0 and 100%* allow values to be defined for the minimum and maximum channel voltages applied to the FBox input.

The *Reset value* parameter corresponds to the value applied to the channel when the PCD is powered up.

Contents

5	PROGRAM STRUCTURES	3
5.1	Introduction	3
5.2	Cyclic Organization Block (COB 0 to 15)	4
5.2.1	Definition	4
5.2.2	Example	5
5.2.3	Add a structure	5
5.2.4	Supervision time	6
5.3	Program Blocks (PB 0 to 299)	7
5.3.1	Definition	7
5.3.2	Example	7
5.4	Function Blocks (FB 0 to 999)	9
5.4.1	Definition	9
5.4.2	Example with a call to a function	9
5.5	View Structure	10
5.6	Exception Block (XOB)	11
5.6.1	Definition	11
5.6.2	All the XOBs of the PCD family	12
5.6.3	Use of XOBs	13
5.6.4	History Table	16
5.6.5	Description of XOBs	17
5.7	Sequential Blocks (SB 0 to 31, 96)	21
5.8	Summary table.	21

5 Program structures

5.1 Introduction

The success of a good program lies in its structure. It simplifies the program, and makes it quick to maintain and develop. The SAIA PCD programming language is a structured language which uses different organisation blocks to hold the application's instructions. Each block type provides different services for the user. These organisation blocks are available: cyclic organisation blocks (COB), function blocks (FB), program blocks (PB), exception organisation blocks (XOBs) and sequential blocks (SB).

5.2 Cyclic Organization Block (COB 0 to 15)

5.2.1 Definition

Cyclic Organization Blocks (COBs) are parts of a program that are executed without program loops and without waiting for events that are internal or external to the PCD. When the PCD starts up, the program executes COB 0 first. COBs 1 to 15 are then executed consecutively, if present in the program. They are automatically called in succession, in a continuous loop.

All signals which need to be dealt with on a regular basis (e.g. end switches for motor movements, external power-cut or emergency-stop signals, human protection devices, ...) have to be inside a COB.

There must to be at least one COB in the PCD!

A proper understanding of the concept of cyclic organization blocks is important. The lack of wait loops is not a shortcoming in the programming, but a safety measure. It is in fact the only way to guarantee that important application signals are checked at regular intervals.

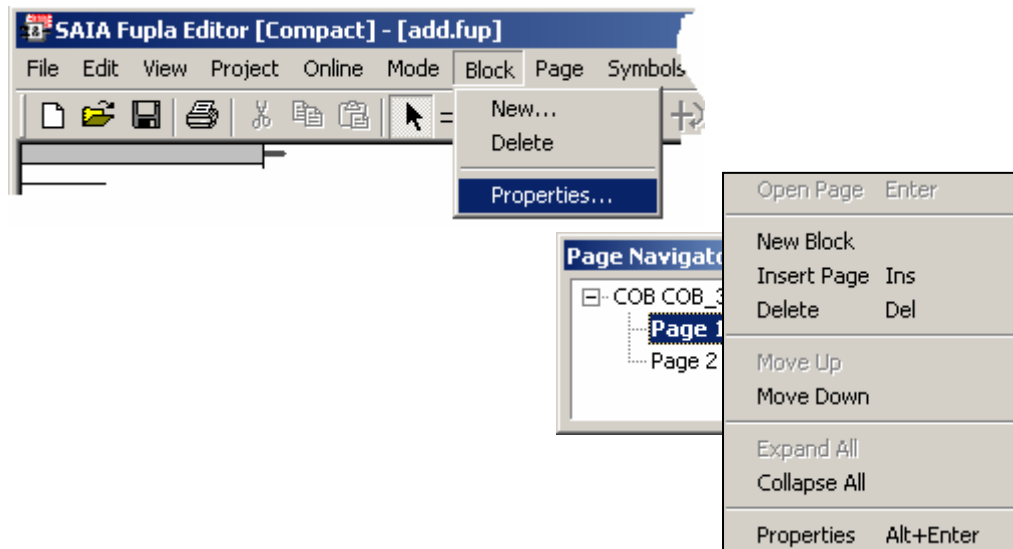

If you write your programs with the Fupla editor, the new files are automatically opened with a COB. You can then change the block type or comment using the *Block, Properties* menu.

In instruction list (IL) programs, the block is defined by instructions which enclose the program code.

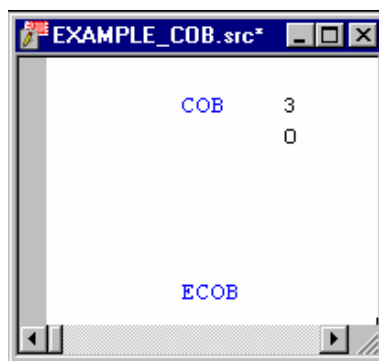

5.2.2 Example

Here you have an example program (shown both in IL and FUPLA) which makes output 64 blink at a rate of 1.5 seconds. The program is written in COB 0, which is then followed by other COBs 1 to 15.

IL program

```

COB 0 ;Start COB 0
      0 ;Supervision time
STL T 1 ;IF timer T1 = 0,
LD T 1 ; load it with 1.5 s.
      15
COM O 64 ;and toggle the output 64
ECOB ;COB 0 ends here

COB 15 ; Next block
      0
NOP
ECOB

;Next COBs
    
```

Fupla program

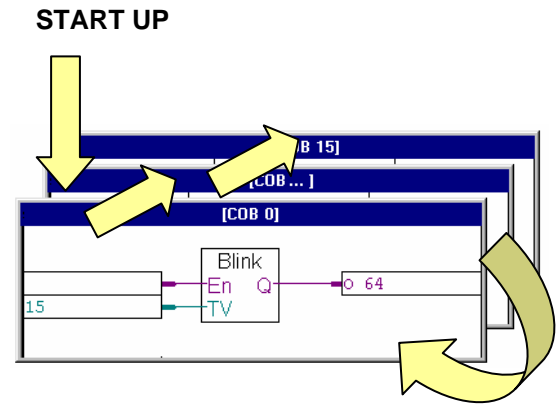

Fbox: *Blinker, Blink delay T*

5.2.3 Add a structure

A Fupla file may contain several program blocks which can be added, deleted or edited using the *Block* menu.

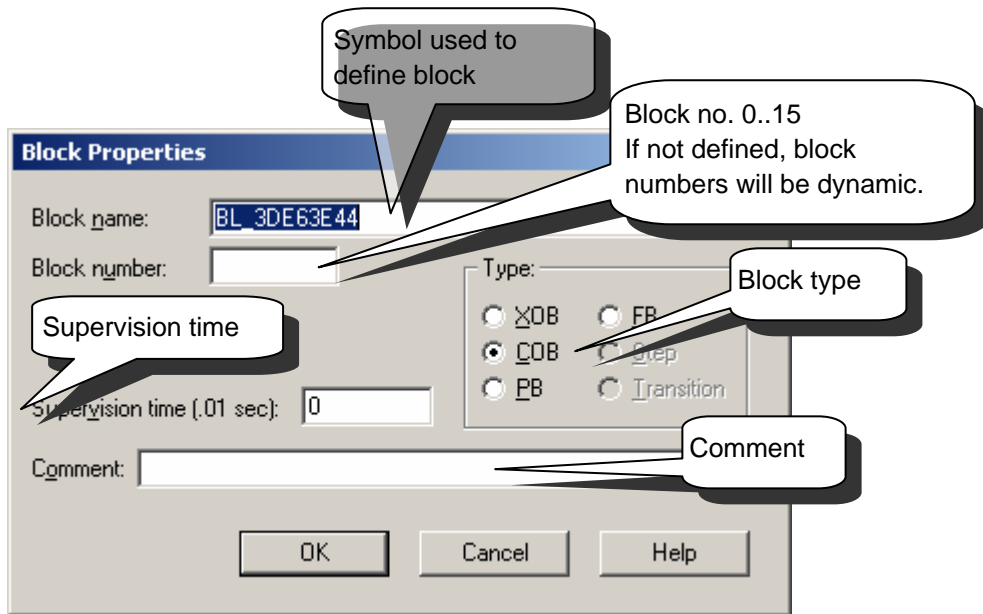

5.2.4 Supervision time

The supervision time allows the definition of a maximum time for processing a COB from start to finish. After this time, two scenarios are possible:

If XOB 11 has not been programmed, the COB will be exited to process successive COBs up to the last one. The error lamp will be on. In the next program cycle, the COB that ran out of supervision time will start up again with a new supervision time from the point where it broke off.

If XOB 11 has been programmed, the COB will be exited to process XOB 11. At the end of XOB 11, the COB that ran out of supervision time will start up again with a new supervision time from the point where it broke off. The error lamp will not be on, because the error was foreseen and handled by the user program.

A supervision time of zero means that the supervision time has been deactivated.

5.3 Program Blocks (PB 0 to 299)

5.3.1 Definition

You may also work with Program Blocks. PBs offer a good way to organize your program in a hierarchical manner. PBs are only activated if they are called from a COB, PB, FB or SB (Sequential Block).

There are two ways to call a PB: conditional call or unconditional call. Conditional calls depend on the result of a logical operation. You can call the same PB several times in the program. One PB can call another PB and so on, up to seven levels of nesting.

Beyond the seventh nesting level, the PCD will call error handler XOB 10.

5.3.2 Example

Realization of a two-speed blinker depending on the logical state of input *Condition*

Fupla program:

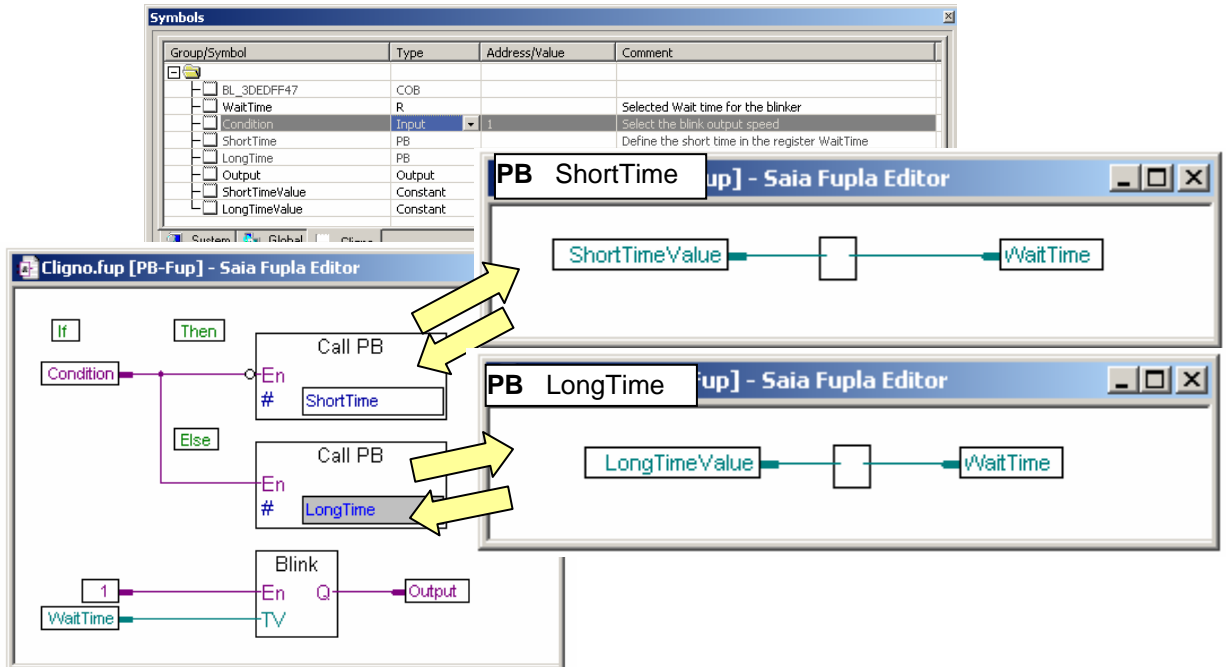

If the logical state of digital input *Condition* is low, the PCD will call PB *ShortTime* and transfer a constant *ShortTimeValue* of 5 to register *WaitTime*. If not, the PCD will call PB *LongTime* and transfer a constant *LongTimeValue* of 15 to register *WaitTime*. The *WaitTime* register defines the length of the pause between two changes of blinker state ("*Blink*"). To ensure initialization of the *WaitTime* register during a cold start, the blinker must be positioned after both PB calls.

IL program:

SAIA IL Editor [PB-IL] - [cligno.src]

File Edit Search View Project Online Tools Symbols Window Help

Group/Symbol	Type	Address/Value	Comment
ShortTimeValue	Constant	5	0.5 s
LongTimeValue	Constant	15	1.5 s
Tempo	Timer		

System Global cligno

```

COB      0
          0
STH      Condition           ;IF (Condition is high)
CPB      L ShortTime         ; THEN Call PB ShortTime
CPB      H LongTime          ; ELSE Call PB LongTime
ECOB

PB       ShortTime
STL     Tempo                ;IF tempo is low
LD      Tempo                ; load it with a short value
COM     ShortTimeValue
EPB

PB       LongTime
STL     Tempo                ;IF tempo is low
LD      Tempo                ; load it with a long value
COM     LongTimeValue
EPB      Output              ; invert the output

```

5.4 Function Blocks (FB 0 to 999)

5.4.1 Definition

Function blocks are nearly the same as PBs. Like PBs, FBs also contain program parts that can be called from other blocks. This call can be conditional or unconditional.

The unique difference is that FBs give you the possibility to call the block with parameters, whereas with PBs you cannot.

FBs offer an ideal solution for developing libraries of programs that can be used for different projects, thereby reducing commissioning times. FBs with parameters can only be called from an IL program.

Function block calls can be nested within each other to a maximum of 7 levels. Beyond 7 nesting levels, the PCD will call an XOB 10.

5.4.2 Example with a call to a function

The following example shows an FB that makes an output blink.

The FB is called twice. Its first call makes output 64 blink at a rate of 1.5 seconds. Its second call makes output 65 blink at a rate of 3 seconds.

```

      FB      1          ;Start FB

tempo DEF  = 1          ;[T]  Address of timer
delay DEF  = 2          ;[W]  Pause between two blinker inversions
blinker DEF = 3          ;[O,F] Blinker address

      STL    =tempo      ;If timer state is low
      LDL    =tempo      ; initialize timer with parameter =2
              =delay
      COM    =blinker    ; invert parameter =3
      EFB

      COB    0
              0

      CFB    1          ;Call FB for first time
              T 1
              15
              O 64

      CFB    1          ;Call FB for second time
              T 2
              30
              O 65

      ECOB

```

5.5 View Structure

Once you have built your program, you can view its block structure. Click on the Button Block Structure View, located on Project Manager's toolbar. This will display the structure, showing which COB calls which PB, FB, or SB. The display below is for the FB example on the preceding page. It shows that FB1 is called by COB 0 twice.

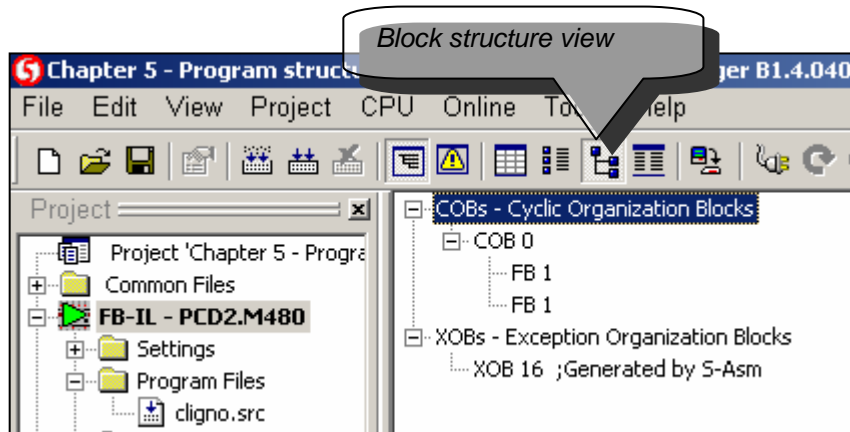

5.6 Exception Block (XOB)

5.6.1 Definition

Exception blocks are programs that are called automatically as soon as a particular event occurs. Each hardware or software event is linked to an XOB. These events cannot be modified by the user. However, the user is free to program the action to be taken inside each XOB.

Example:

When the power is switched on, the PLC must zero a register that serves to count pulses INB1 at a maximum frequency of 1 kHz. No special program is necessary within the COBs !

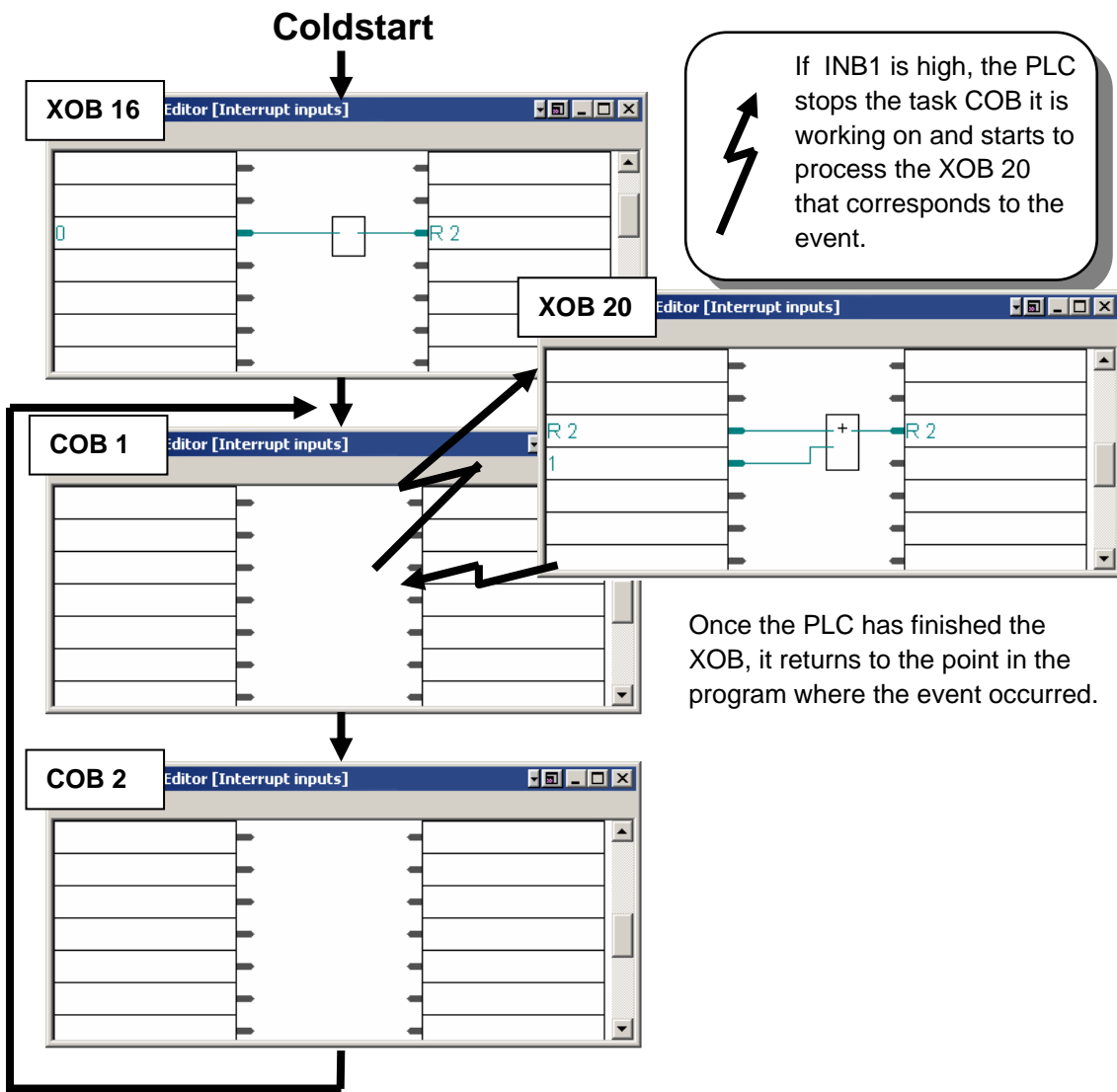

Example:

Turn on your PCD, take out the battery and the error LED will light up. If your program had included an XOB 2 (see table), the LED would not have come on and XOB 2 would have been executed instead.

5.6.2 All the XOBs of the PCD family

XOB	Description	Priority
0	Power problem in the main rack (PCD6) or Watchdog (PCD1/2)	4
1	Power problem in the extension rack (PCD 6)	2
2	Battery low	2
4	Parity error on the I/O bus (PCD6)	1
5	No response on a module I/O (PCD4/6)	1
7	Overload of the system due to multiple events.	3
8	Instruction not valid	4
9	To many active tasks (Graftec)	1
10	To many PB/FB levels	1
11	Watchdog COB	3
12	To many index registers used	1
13	Error flag is set	1
14	Interruption cyclic	3
15	Interruption cyclic	3
16	PCD cold start	4
17	S-Bus telegram	3
18	S-Bus telegram	3
19	S-Bus telegram	3
20	Interrupt input INB1	3
25	Interrupt input INB2	3
30	No connection with RIO	1

If an error occurs and the corresponding XOBs have not been programmed, the error LED on the front of the PCD will come on and the user program will continue its work.

If an error occurs and the XOBs have been programmed, the error LED on the front of the PCD will remain off and the exception routine will be called.

A prioritising mechanism ensures processing of the most important XOBs. Priority level 4 is highest.

5.6.3 Use of XOBs

Help find errors in your program configuration:

- errors in module addresses
- more then seven program levels
- more then 32 active transitions in a Graftec structure
- never-ending loop
- error in a mathematical operation
- errors in communication

Fupla example:

Use of all available tools for the systematic location of a user program error.

With Fupla it is not even necessary to create XOBs. They are added automatically by the Fbox: *Special, Diagnostic XOB*

Diagnostic information is available on the function outputs, error counter, XOB number, program line number,...

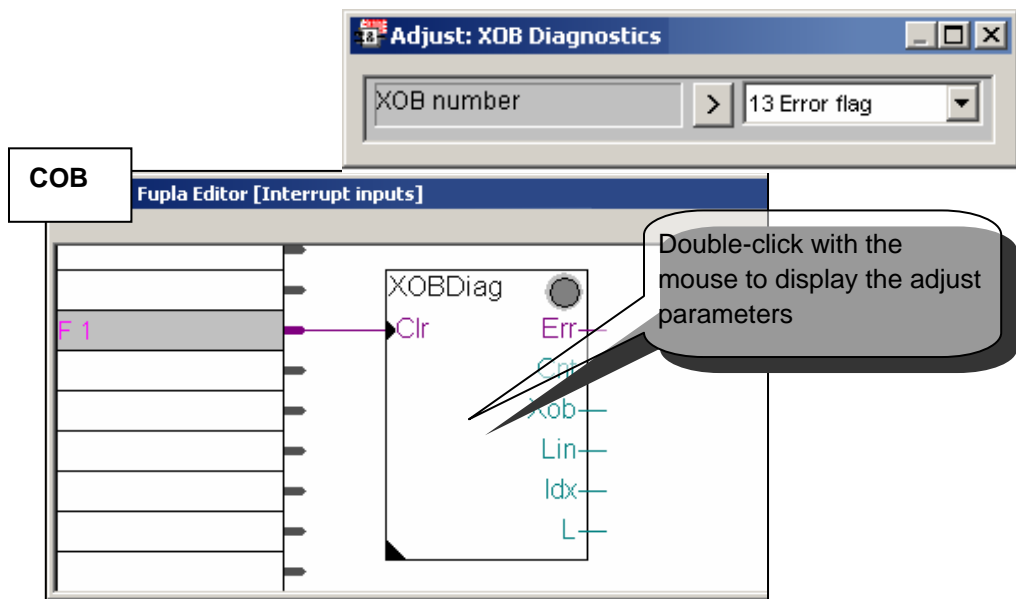

IL example:

The IL program's diagnostics supply the same information as above in registers Rdiag + 0 ... +12.

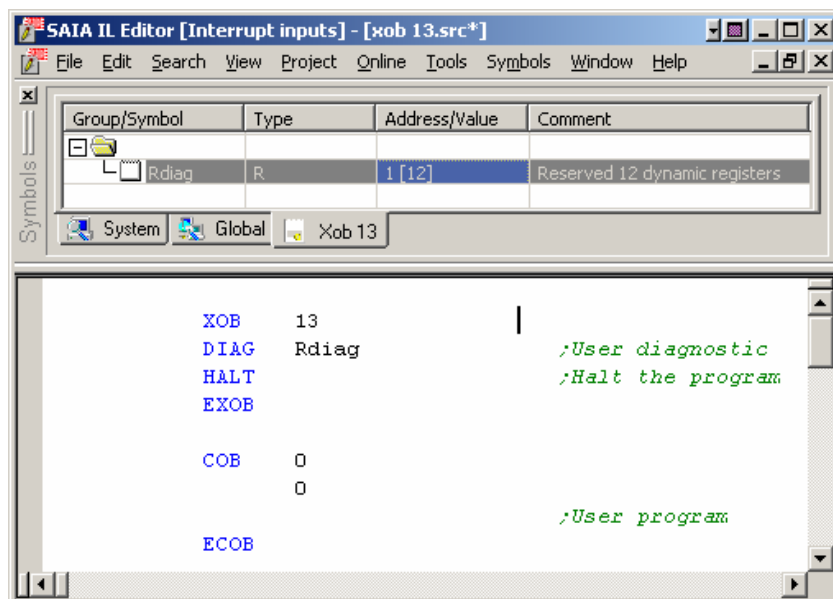

Maintenance of your PLC:

- Monitoring of batteries (need to be changed every 3 to 4 years)

Fupla example:

With Fupla it is not even necessary to create an XOB 2 block. It will be added automatically by the Fbox: *Special, Battery*

The Battery_Failure output will be high for any battery problem.

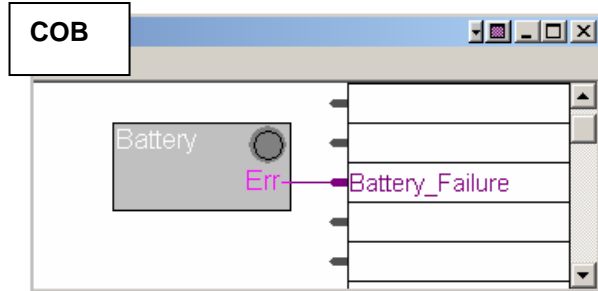

IL Example:

If there is a PCD battery failure, the battery lamp on the front of the PCD will come on and XOB 2 will then be called automatically at regular intervals.

In the above example, XOB 2 loads a timer with a delay of 1 second. As the exception block is called regularly, the timer will be initialised frequently and will not have the chance to count down to zero. The binary state of this timer will therefore be high for a battery failure, falling to low approximately 1 second after the battery has been replaced.

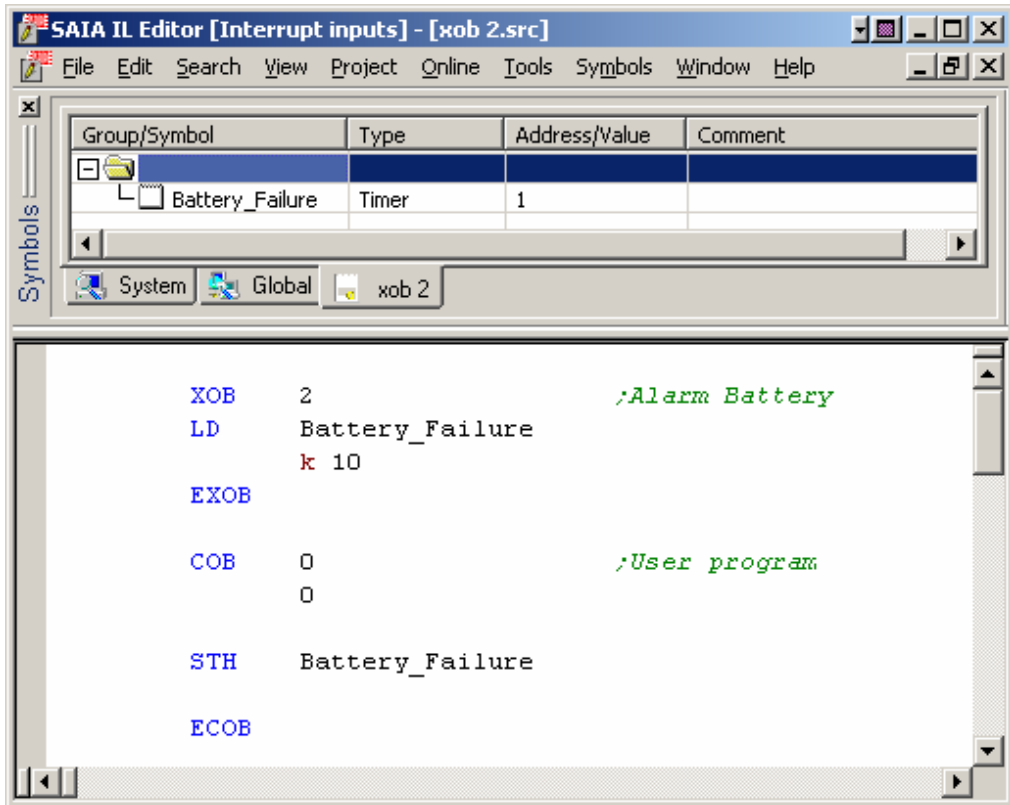

Monitoring special events or very fast reactions to external signals:

- interrupt inputs
- interruption of the program every once in a while
- interruption of the program when a telegram arrives
- cold start. Initial values

Fupla example:

Output pulses to a digital output. Use functions *Special* , *Install cyclic task* and *Binary Direct transfer*.

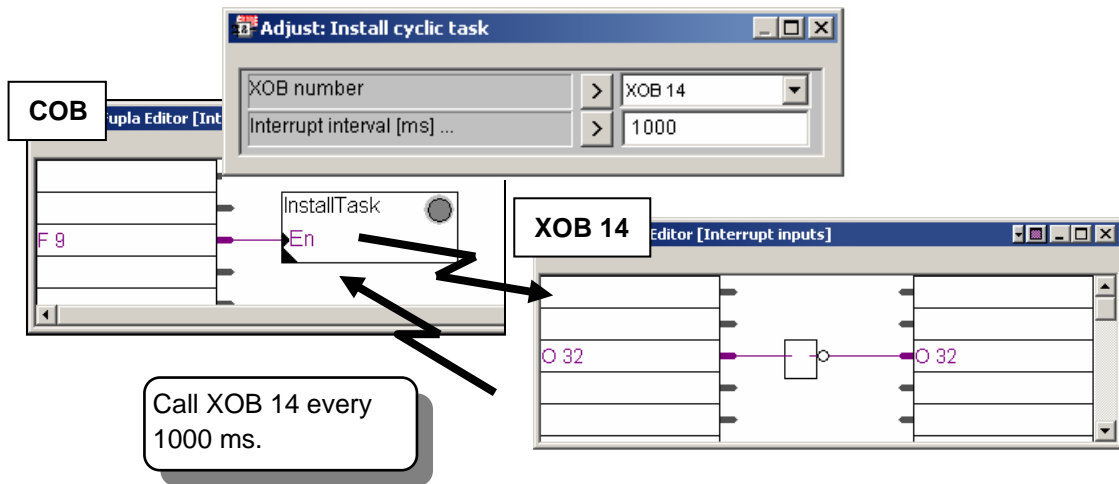

IL example:

```

XOB      16
SYSWR    4014      ;Initialise XOB 14
                    ;with a 1000 ms interrupt

EXOB

COB      0
          0
                    ;User program

ECOB

XOB      14      ;Cyclic interrupt
COM      O 32    ;with inversion of output O 32
EXOB
    
```

5.6.4 History Table

The *PCD History Table* lists all the hardware and software errors that have occurred. This table is updated even if the XOBs are not programmed.

To consult the history table, click on the *Online Configurator* button or go via the menu *Tool, Online Configurator*



Online Configurator

Reason	Address	Time	Date
>7 CALL LEVELS	30	14:09:43	06/01/2003
>7 CALL LEVELS	30	14:09:43	06/01/2003
>7 CALL LEVELS	30	14:09:43	06/01/2003
>7 CALL LEVELS	30	14:09:43	06/01/2003
>7 CALL LEVELS	30	14:09:44	06/01/2003
>> >7 CALL LEVELS	30	14:09:44	06/01/2003
>7 CALL LEVELS	30	14:09:44	06/01/2003
>7 CALL LEVELS	30	14:09:44	06/01/2003
>7 CALL LEVELS	30	14:09:44	06/01/2003
>7 CALL LEVELS	30	14:09:44	06/01/2003
>7 CALL LEVELS	30	14:09:44	06/01/2003
>7 CALL LEVELS	30	14:09:44	06/01/2003
>7 CALL LEVELS	30	14:09:44	06/01/2003
>7 CALL LEVELS	30	14:09:44	06/01/2003
BATT FAIL	816 0	14:09:43	06/01/2003
IR OVERFLOW	0 0	12:00:00	06/01/2003
ERROR FLAG	772 6	14:09:44	06/01/2003

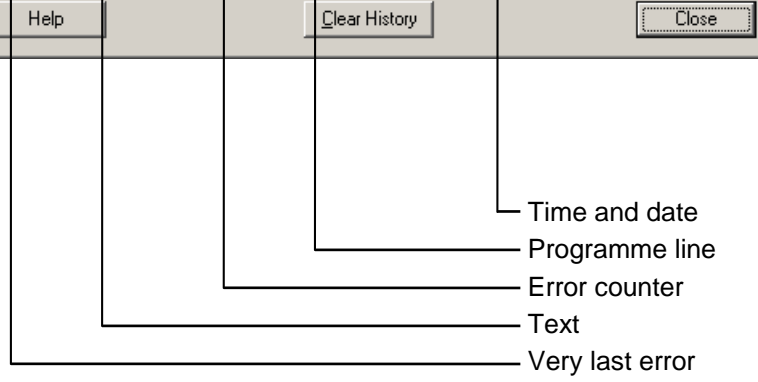

Note:

- Every CPU has his own history.
- The line *BATT FAIL* only exists on CPU 0.
- If the error can be assigned to a program line, the line will be indicated. Otherwise it will be displayed in hexadecimal.
- XOB 0 is only called if it has been programmed.

5.6.5 Description of XOBs

XOB 0: Power failure in main rack

The voltage monitor in the supply module of the main rack has detected an excessive drop in voltage.

In this case, all outputs are reset as follow:

- for the PCD4: immediately
- for the PCD6: after 1.5 ms.

XOB 0 is invoked and all CPUs are put into the HALT state.

From the moment when XOB 0 is invoked until CPU HALT is an interval of approx. 5 ms. During this time, XOB 0 continues processing, so that data can still be saved.

XOB 1: Power failure in extension rack (PCD6)

The voltage monitor in the supply module of an extension rack (PCD 2 or PCD6) detected an excessive drop in voltage.

In this case all outputs of the extension rack are set low within 2ms and XOB 1 is called.

If outputs from this “dead” extension rack continue to be handled (set, reset or polled) by the user program in any CPU, XOB 4 and/or XOB 5 are also called.

XOB 2: Battery failure or low battery

The battery is low, has failed or is missing.

Information in non-volatile flags, registers or the user program in RAM as well as the hardware clock may be altered. After prolonged non-use of the PCD (more than 2 months without supply) battery failure can be indicated also, but without leading to loss of data.

Even a new PCD which has never been used can show the same symptoms.

XOB 4 : Parity error on address bus (PCD6)

XOB 4 can only be called if the PCD has extension racks.

The monitor circuit of the address bus has noticed a parity error. This can either arise from a faulty extension cable, a defective extension rack or from a bus extension module, or else it is simply because the extension rack addressed is not present. If there is a fault, the wrong element could be addressed.

XOB 5: No response from I/O module (PCD4/6)

The PCD's input and output modules return a signal to the CPU which has addressed them. If this signal is not returned, XOB 5 is called.

Generally occurs if the module is not present, but it can also happen in case of faulty address decoding on the module.

For a PCD4 module with only 8 elements, XOB 5 is not called if one of the absent elements is addressed, since this address is still decoded and the signal is sent. For the PCD6, this signal is only returned by the new PCD6 modules.

Most of the PCA2 modules used up to now do not cause invocation of XOB 5, even when they are absent.

XOB 7: System overload

The waiting mechanism for XOBs with priority levels 2 or 3 is overloaded.

If a level 2 or 3 XOB is processed at the same instant as an XOB with a higher priority (level 4), the lower priority XOB is put on hold until the XOB with priority has finished. XOB 7 is called when the queue is full.

XOB 8: Invalid opcode

The CPU has noticed an invalid instruction code.

If edited user programs or routines are assembled, linked and loaded into the PCD, incorrect opcodes cannot occur because the program is very strictly checked by both the IL editor (S-Edit) and then by the assembler. However, if the user program is subsequently changed directly using the Debug program or with the hand-help programming unit, almost any error could be introduced, which could lead to the invocation of XOB 8.

Errors often incorporated in this way are: calling non-existent blocks; missing end of block instructions; program jumps to the second line of multi-line instructions; jumps from one block into another, etc.

XOB 9: Too many active GRAFTEC branches

More than 32 Graftec branches were simultaneously activated in a Sequential Block (SB). Of course, more than 32 parallel branches can be programmed in a single SB, however, only a maximum of 32 are allowed to run simultaneously.

XOB 10: More than 7 nested PB/FB calls

PBs and FBs can be nested to a depth of 7 levels. An additional call (calling the 8th level) results in XOB 10 executing. The 8th level call is not executed.

XOB 11: COB monitoring time exceeded

If the second line of the COB instruction indicates a monitoring time (in 1/100 seconds) and if COB processing time exceeds this defined duration, XOB11 is called. COB processing time is the time which can elapse between the COB and ECOB instructions. The original purpose of this monitoring time was the immediate discovery and subsequent eradication of any blockage or delay in the user program resulting from bad programming (wait loops, over-long count loops). It is in fact, a "software watchdog". As already mentioned, wait and count loops (program jumps) are not encouraged. This minimizes the possibility of blocking user programs. However, even in properly structured programs, one or more COBs may be programmed with very lengthy mathematical calculations etc. which cause a long execution time, and other COBs with only monitoring and control functions may be delayed.

If a monitoring time defined for this lengthy calculation program elapses, the COB will be abandoned to continue from the start of the next COB. The "release point" is automatically stored in memory together with the ACCU status.

When the original COB is next invoked, it will continue from the release address+1. If this technique is used, XOB 11 should not be programmed as otherwise time is wasted when the timeout is not actually an error.

A further programming technique (timeslice) is explained in "Other programming techniques".

XOB 12: Index Register overflow

The size of the Index Register is 13 bits (0 to 8191). This is sufficient to reference all element addresses.

If a program contains an indexed element which falls outside its address range, then XOB 12 is called.

For example, the indexed Flag 8000 is referenced and the Index Register contains 500, such that flag 8500 would be referenced, which lies outside the Flag's address range of 0 - 8191.

XOB 13: ERROR flag set

Many instructions in the PCD instruction set can set the Error flag, see the "Reference Guide": line "FLAGS".

If an error should arise, apart from setting the Error flag, XOB 13 is also called so that any general arrangements (alarm, error message to a printer, etc.) can be made. XOB 13 is always called when the Error flag is set, irrespective of whether the cause is a calculation, data transfer or communications error.

If a more closely derived diagnosis is required for the Error flag, a PB (or FB) can be conditionally called after every instruction which could set the Error flag.

Example:

```
....
DIV  R 500 ; value 1
R 520      ; value 2
R 550      ; result
R 551      ; remainder
CPB  E 73   ;if error then call PB 73 ....
....
PB   73     ; Divide by zero
SET  O 99
INC  C 1591
EPB
...
```

PB 73 is called after a division by zero and turns on Output 99, indicating division by zero. Counter C 1591 counts how often this event occurs. An overflow from multiplication could, for example, activate output 98 and Counter C1590 could count these events.

XOB 13 should also be programmed, but can be empty.

If it is not programmed, the Error lamp on the CPU front panel is turned on when the Error flag is set, which may not be satisfactory.

**IMPORTANT:**

The Error flag and other arithmetic status flags (Positive, Negative, Zero) are set in case of a particular event or state, and, if they are of interest, must be processed immediately, as these status flags always refer to the last executed instruction which can affect them.

For example, if a correct addition had followed the division by zero example above, the Error flag would be reset.

XOB 14, 15: Cyclic interrupt XOBs

XOBs 14 and 15 are called periodically with a frequency of between 10 ms and 1000 s. This frequency can be defined with the instruction SYSWR.

XOB 16: Coldstart

XOB 16 is a coldstart block. It is processed when the PCD is powered up or when a coldstart command is received from a programming tool. XOB 16 is used to initialise all sorts of information before processing the program. Once XOB 16 is finished, the program will process COBs in ascending number order, but will never return to XOB 16.

XOB 16 cannot be restarted by the user program. If a particular action has to be executable both by a COB and during initialisation, this action must be written in a PB or FB which can equally be called from XOB 16 or from a COB.

XOB 17, 18, 19: Request to interrupt an XOB via S-Bus

These three XOBs can be used as interrupt routines. It is possible to start processing them via the S-Bus communications bus. The instruction SYSWR or Fupla function *Special, execute XOB* can be used to start them.

XOB20 & XOB 25: Interrupt input change detected

XOB 20 (or 25) is called when interrupt input INB1 (or INB2) of the PCD2 has detected a rising edge (see PCD2 hardware manual for further details).

XOB 30: Loss of master slave connection with RIOs

The connection is tested after each message sent by the master station to the slave station. If the test is negative, the CPU master calls XOB 30. This occurs, for example, when an online station is disconnected from the network or powered off.

5.7 Sequential Blocks (SB 0 to 31, 96 ¹)

Sequential blocks SB are a collection of Steps and Transitions.

In each step you execute a part of your program and in each transition you wait for a condition to occur in order to continue with the following step. This is known as a Graftec program.

Graftec programs are created using a special editor called S-Graf, and the files have the extension *.sfc. The Graftec editor is explained in the next chapter. It is an excellent tool if you have to solve programming tasks, where your installation deals with a situation in a sequential manner.

SBs can be called from any other block.

5.8 Summary table.

Service	Média	Opérand	Notices
Cyclic Organization Block	COB	0...15	Minimum 1 COB by program
Programme Block	PB	0...299	Under programs called by a COB, PB,FB,SB or XOB
Function Block	FB	0...999	Function with parameters called by a COB, PB,FB,SB or XOB
Sequential Block	SB	0...32 0...96 ¹	Sequential under programs called by a COB, PB or FB (SB, XOB)
Step	ST	0...1999 0...5999 ¹	
Transition	TR	0...1999 0...5999 ¹	

¹ PCD2.M170/480, PCD4. M170 et PCD3

Contents

CONTENTS	1
6 GRAFTEC PROGRAMMING	3
6.1 Introduction	3
6.2 Sequential Blocks (SB 0 to 31, 96)	4
6.3 Cyclic Blocks	5
6.3.1 Cyclic programs	5
6.3.2 Cycle time	5
6.4 Make a new Graftec file	6
6.4.1 Create new project	6
6.4.2 Create a new Fupla or IL file	6
6.4.3 Call the SB from a COB	7
6.4.4 Create a new Graftec file	7
6.5 SB organisation	8
6.5.6 <i>Block Navigator</i>	8
6.5.7 General structure of an SB	9
6.5.8 Rules of evolution	9
6.5.9 Transitions (TR 0 to 1999)	10
6.5.10 Steps (ST 0 to 1999)	11
6.6 Typical sequential block structures	12
6.6.1 Simple sequence	12
6.6.2 Alternative branching (OR)	12
6.6.3 Simultaneous branching (AND)	12
6.6.4 Jump over a sequence	12
6.6.5 Repeat a sequence	12
6.7 Edit a sequence	13
6.7.6 Edit a simple sequence	13
6.7.7 Edit a connection	13
6.7.8 Draw an alternative task (OR)	14
6.7.9 Close an alternative task	14
6.7.10 Edit a simultaneous task (AND)	14
6.7.11 Close simultaneous task	14
6.7.12 Add a comment	14
6.7.13 Insert a sequence	15
6.7.14 Delete a sequence	15
6.7.15 Copy-paste a sequence	16
6.8 Write your first sequential block	17
6.8.1 Open the file	17
6.8.2 Draw the basic structure	17
6.8.3 Choice the IL or Fupla editor	18
6.8.4 Prepare the symbols	19

6.8.5	Edit the program code	19
6.8.6	How to program a transition	19
6.8.7	Using timers in an SB	20
6.8.8	Wait on the timer decrementation:	20
6.8.9	Repeat the step and transition for the time were the pulse is off	21
6.8.10	Decrement a counter	21
6.8.11	Alternate branching	22
6.9	Build and debug your program	23
6.9.1	Message Window	23
6.9.2	Online tools	23
6.10	Graftec structure with pages	24
6.10.1	Define a page	24
6.10.2	Edit a page	25

6 Graftec programming

6.1 Introduction

The Graftec editor is provided for creating sequential programs using the Fupla or IL languages. This chapter introduces the use of Graftec to edit programs that contain sequential blocks (SBs), steps and transitions.

6.2 Sequential Blocks (SB 0 to 31, 96¹)

In the following pages we will describe a program structuring technique called Graftec (or Sequential Function Chart), which is particularly effective for sequential programs where it is necessary to wait for events that may either be programmed or external to the controller.

Because these waits are of indeterminate length, we cannot estimate the cycle time of sequential programs. It is therefore important to separate cyclic programs completely from sequential programs.

Waiting for a sequential event must never block the continuous execution of cyclic programs. To meet this requirement, sequential programs are located inside one of the 32 available SB structures that can be called in each program cycle.

A particular feature of SBs is the fact that, when a sequential program located within the SB is waiting for an event, the PCD will set aside that SB and continue processing the cyclic programs. The rest of the SB will then be processed during the next program cycle.

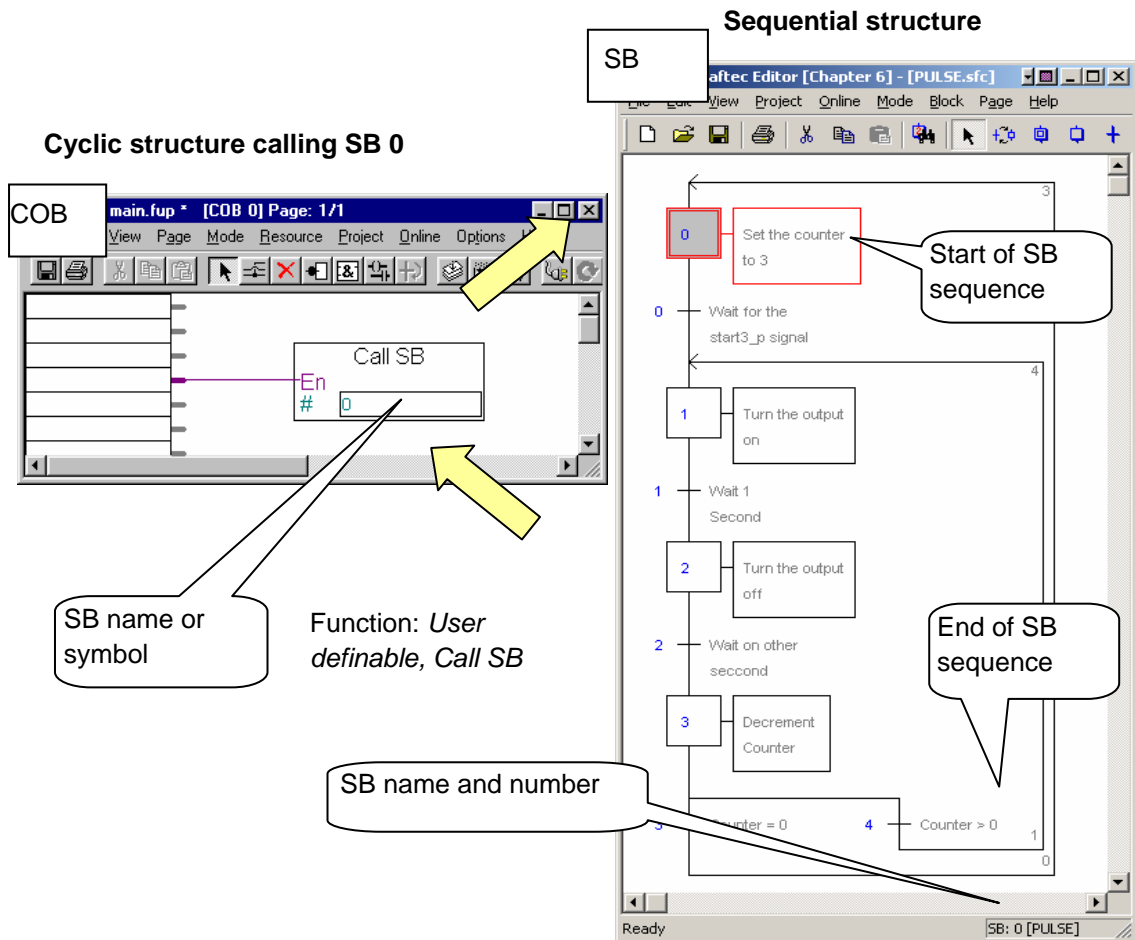

¹ The new PCD2/4.M170, PCD2.M480 and PCD3 support until 96 SB

6.3 Cyclic Blocks

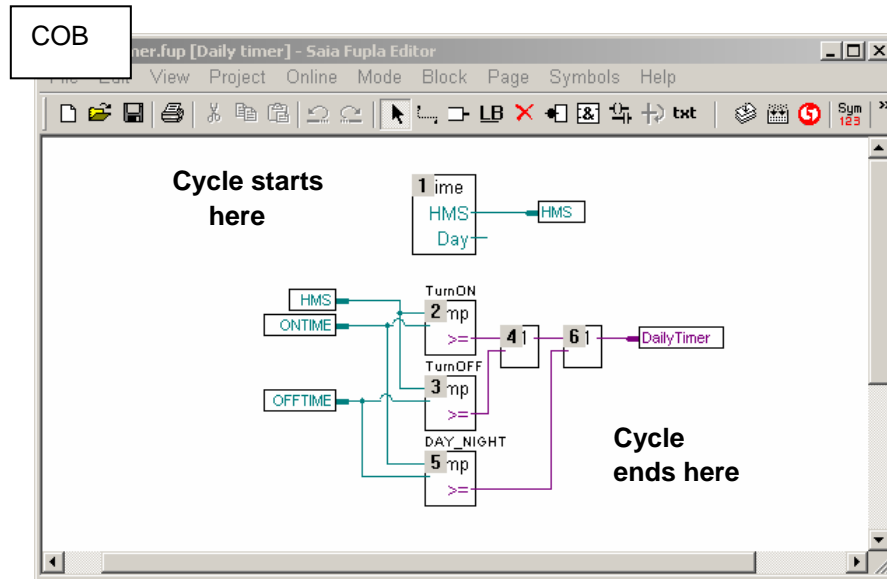

6.3.1 Cyclic programs

Programs presented previously have been entirely cyclic: created from a list of graphical functions or instructions that are processed one after another by the PLC as quickly as possible from program start to end, then it returns to the beginning of the task for a new cycle.

6.3.2 Cycle time

The time required to process a program cycle is fixed. It corresponds to the sum total of execution times for each instruction and function. This is what we call the *cycle time* of a program.

Generally, the cycle time amounts to a few milliseconds. If information at a digital input changes state, digital outputs dependent on the input states can be updated with a refresh time that is almost instantaneous. The delay is, in fact, equivalent to the cycle time.

Cyclic programs belong to structures of the types: COB, PB, FB or XOB.

6.4 Make a new Graftec file

As an example, we recommend the creation of a new project in which we are to prepare files for editing Graftec programs:

For graphical programming, prepare one Fupla file and a second Graftec file.
For instruction list programming, prepare one IL file and a second Graftec file.

6.4.1 Create new project

From the SAIA Project Manager window, select the menu *Project, New...* and create the new project.

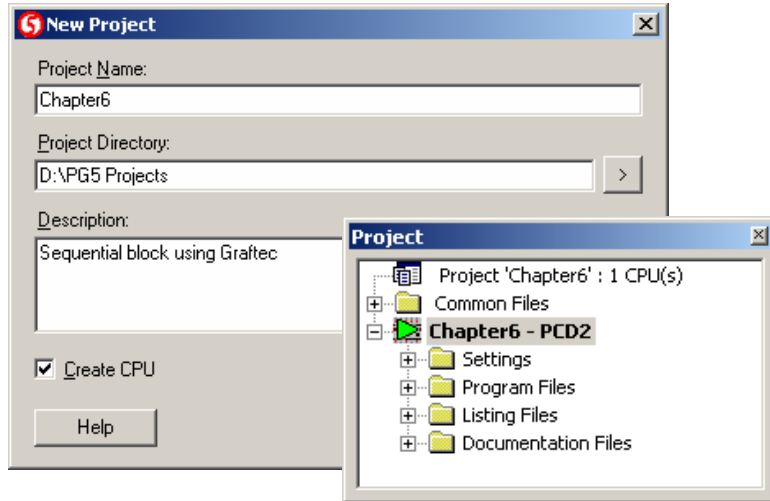

6.4.2 Create a new Fupla or IL file

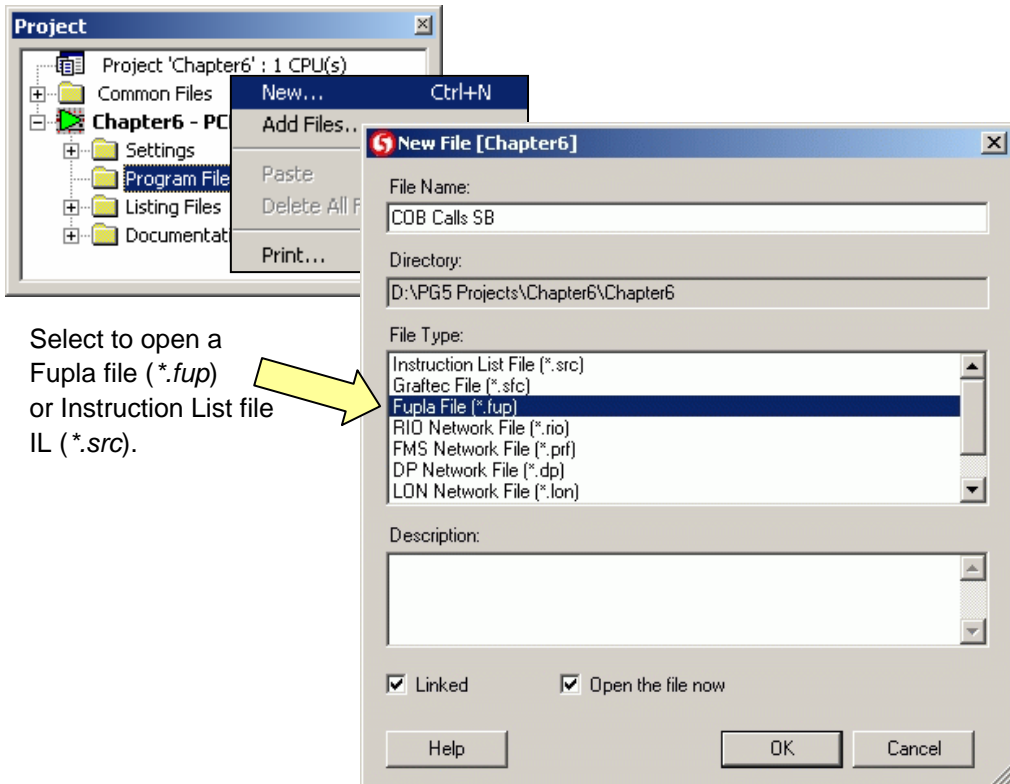

6.4.3 Call the SB from a COB

Depending on the way you intend to write your program (IL or Fupla) you call the SB using an instruction *CSB* or a function *Call SB*. There is no difference between the two examples. Open the new file and write the program as shown below.

IL program:

```

COB 1      ;Cyclic Block
starts
0

CSB 0      ; calls the SB 0

ECOB      ;Cyclic Block
          ;ends
    
```

Fupla program:

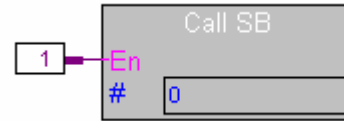

Fbox: User definable, Call SB

6.4.4 Create a new Graftec file

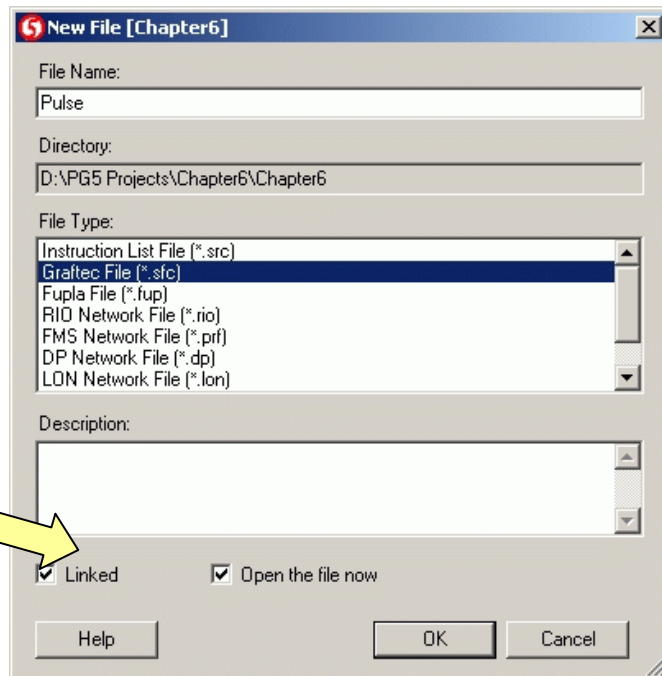
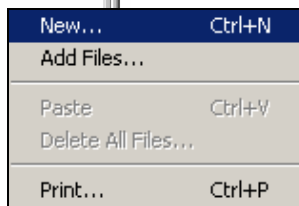
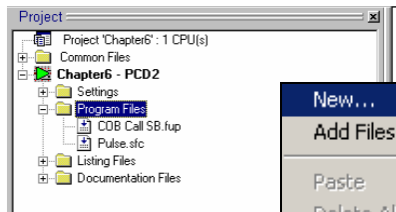

Select to open a Graftec file (*.sfc)



6.5 SB organisation

6.5.6 *Block Navigator*

When a Graftec file is created, the editor generates the sequential block SB 0 and an initial step. If the *Block Navigator* button is selected, it displays a list of all SBs and pages that make up the file.

To add a new SB to the file, position the mouse pointer on the *Block Navigator*, right-click with the mouse and select context menu *New Block*.

The field *Number* shows the number of the SB. Do not confuse the SB number with step and transition numbers. The SB number includes all the sequence of steps and transitions in the SB identified by the symbol in the *Name* field. You are advised to name each SB with a symbol, because this makes blocks easier to navigate.

To display the Graftec structure of any SB present in the *Block Navigator*, position the mouse pointer over the block and select context menu *Open Block*

The *Properties* context menu lets you modify the name and number of any block selected in the *Block Navigator*.

We can now structure the SB with steps and transitions.



Block Navigator

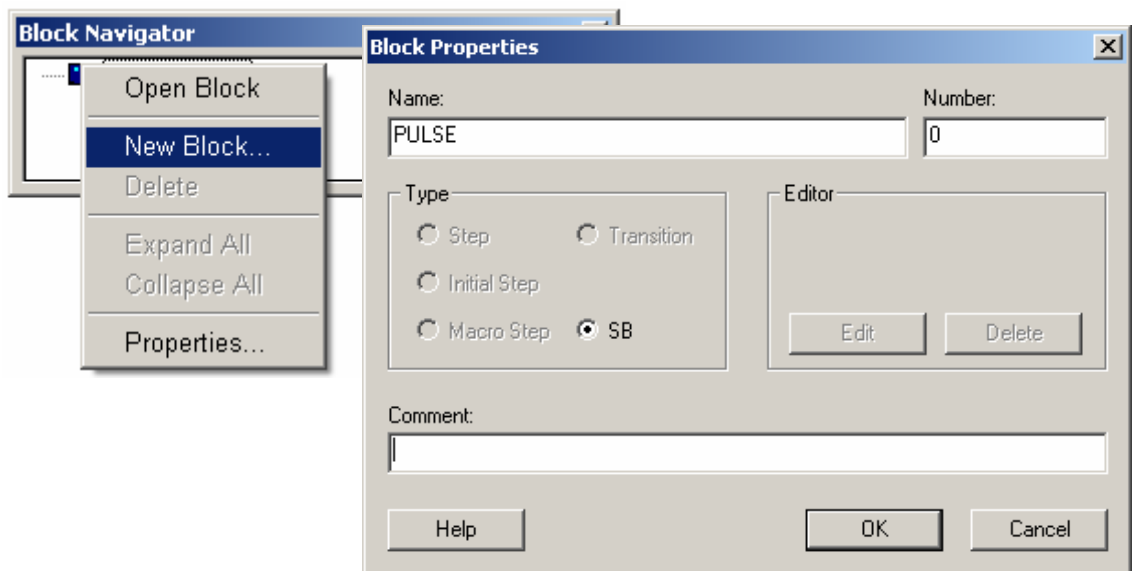

6.5.7 General structure of an SB

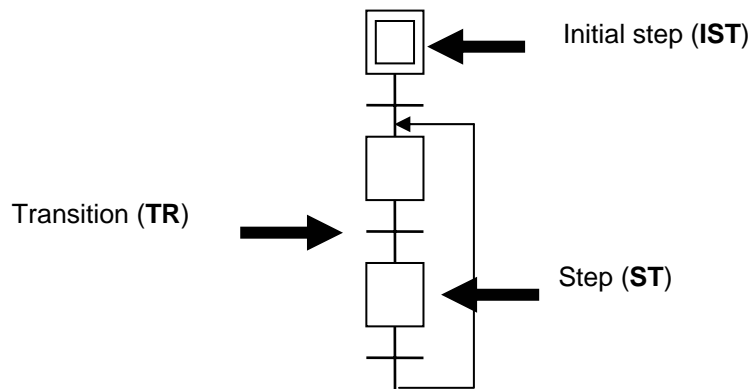

The Graftec editor allows the structure of sequential blocks to be edited as a sequence of steps and transitions, into which the user writes code in the form of graphical functions or instruction list.

A sequential block (SB) starts with an initial step, the symbol for which is a double square. It represents the start of the program. This is where the program will start when the block is called for the first time (coldstart).

6.5.8 Rules of evolution

Sequential blocks have a strict syntax.

A sequential block always starts with an initial step, then transitions and steps must alternate all the time. So you must never have two steps or transitions connected together.

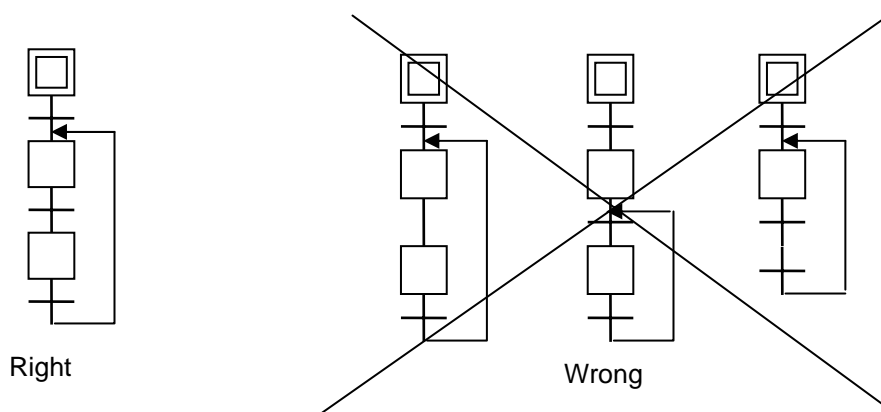

6.5.9 Transitions (TR 0 to 1999 ¹)

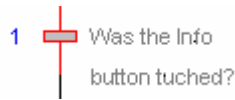

Put into a transition any part of a program that has to run repeatedly until a certain situation occurs, for example:

- wait for a character from a serial port
- wait for the end of a timer
- wait on an end switch

The transition always ends with an *ETR* FBox. The transition is repeated continuously if the *ETR* FBox input is low, or if the ACCU is low at the end of an instruction list transition.

Example: flag 2 is toggled with each program cycle until input 0 is high..

Fupla program:

IL program:

You do not have to insert a program in every transition. A transition without a program is always true and will be skipped.

Transitions written in instruction list: the ACCU is always high at the beginning of a transition or a step.

You can edit a maximum of 32 ¹ sequential blocks with 2000 ¹ steps and transitions.

¹ The new PCD2/4.M170, PCD2.M480 and PCD3 support up to 6000 ST/TRs and 96 SBs

6.5.10 Steps (ST 0 to 1999 ¹)

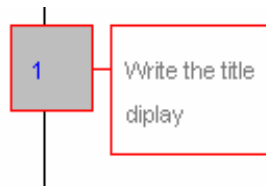

Steps normally contain the 'action' parts of a program, which are executed once when the preceding transition activates.

You want to make your motor move from A to B.

Typically you would first set the speed and direction of the movement. Then you would start the movement. Both these tasks are non-repetitive and can be in a single step, since the step is only executed once.

Once movement is underway, you have to monitor it and stop the motor as soon as it arrives at destination B. This monitoring (for example: reading the end-switch) has to be done over and over again until the motor arrives. This would ideally take place in a transition, because transitions are executed cyclically.

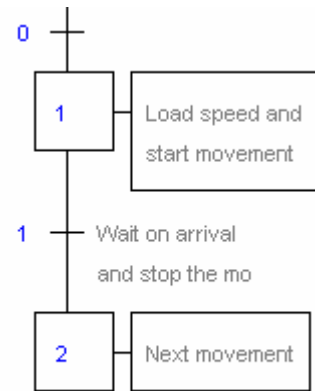

A step without a program goes directly to the next transition.
 A step is only processed once! A step is not cyclic!

¹ The new PCD2/4.M170, PCD2.M480 and PCD3 support up to 6000 ST/TRs and 96 SBs

6.6 Typical sequential block structures

6.6.1 Simple sequence

The simple sequence comprises alternating steps and transitions. There cannot be two steps or two transitions in a row.

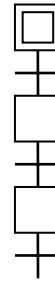

6.6.2 Alternative branching (OR)

Alternative branching is a choice of one sequence among several possibilities. Transitions are executed from left to right, and the first transition to have a true condition determines which sequence is processed.

Alternative branching always begins with one step branching into a number of transitions and ends with an inversion of that structure: a number of transitions channelled into a single step.

The Graftec editor supports up to 32 branches. Above 32 branches, the PCD calls XOB 9 (see chapter 5).

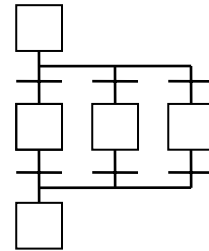

6.6.3 Simultaneous branching (AND)

Simultaneous branching comprises a number of sequences that are to be processed at the same time.

Simultaneous branching always begins with one transition branching into a number of steps and ends with an inversion of that structure: a number of steps channelled into a single synchronizing transition. The Graftec editor supports up to 32 branches. Above 32 branches, the PCD calls XOB 9 (see chapter 5).

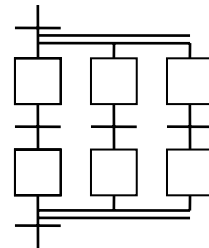

6.6.4 Jump over a sequence

Alternative branching can be used to skip a sequence, thereby allowing the conditional processing of that sequence.

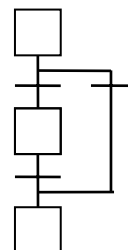

6.6.5 Repeat a sequence

Repetition of a sequence is also possible with alternative branching. For example, a counter is initialised with a number of program loops. You then enter a simple sequence of any length, decrement the counter and, if the counter has not reached zero, the loop is repeated.

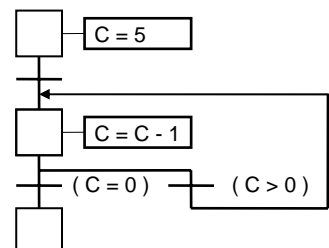

6.7 Edit a sequence

Once you open a new Graftec file, the initial step is displayed. The execution of an SB always starts from here. New elements can be added to the drawing either with the toolbar or the keyboard.

6.7.6 Edit a simple sequence

1. Select button *Mixed mode*
2. Move pointer onto the initial step and click the left mouse button.
3. Move pointer onto the new transition and click the left mouse button again.
4. Follow this format.

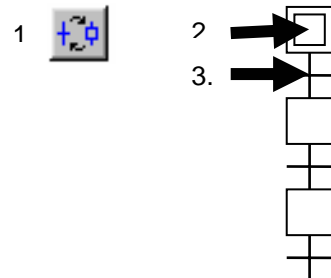

6.7.7 Edit a connection

Once the sequence is finished the program is finished also. If you want the program to restart, then add a loop. You cannot draw a connection between two steps or between two transitions. A loop always starts at a transition and goes to a step.

1. Select the button *Select mode*
2. Mark the transition you start from.
3. Select the button *Link mode*
4. Click on the step that you want to connect to the transition.

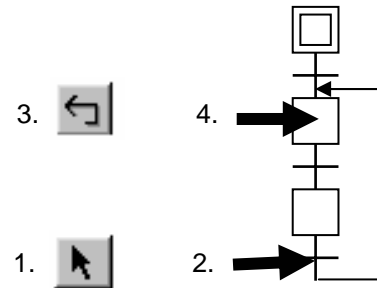

6.7.8 Draw an alternative task (OR)

1. Select the button *Transition mode*
2. Click on a transition followed by a step.
3. An additional transition is drawn with each mouse click

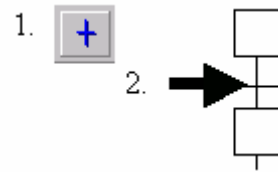

6.7.9 Close an alternative task

In order to resynchronize your alternative task:

1. Select the button *Select mode*
2. Mark the transition you want to close.
3. Select the button *Link mode*
4. Click on the step you want to connect.

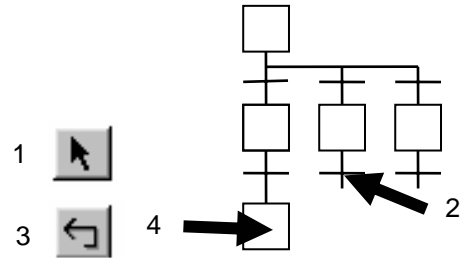

6.7.10 Edit a simultaneous task (AND)

1. Select the button *Step mode*
2. Click on a step followed by a transition.
3. An additional step is drawn with each click.

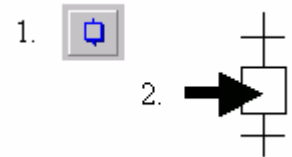

6.7.11 Close simultaneous task

In order to close your simultaneous task:

1. Select the button *Select mode*
2. Mark the step you want to close
3. Select the button *Link mode*
4. Click on the transition you want to connect

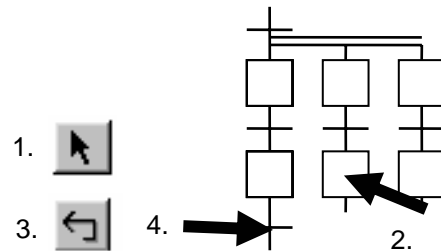

6.7.12 Add a comment

1. Activate the button *Select mode*
2. Use the right mouse button to click on an element. Choose the menu *Properties...*
3. Enter the comment in the *Comment* field

Note:

To edit a comment over two lines, insert the characters \n .

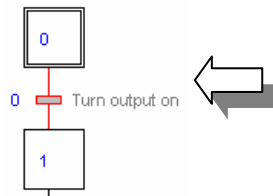

0	Edit Code	Enter
0	Cut	Ctrl+X
1	Copy	Ctrl+C
1	Paste	Ctrl+V
1	Delete	Del
2	Properties...	Alt+Enter

Element Properties

Name: PULSE_ST_1 Number:

Type: Step Transition

Initial Step

Macro Step SB

Editor: Function Block Diagram

Comment: Turn the output on

6.7.13 Insert a sequence

1. Select the button *Transition mode*
2. Click on a step followed by a transition
3. The editor will insert a new transition and a new step.

The editor adds a new step and transition.

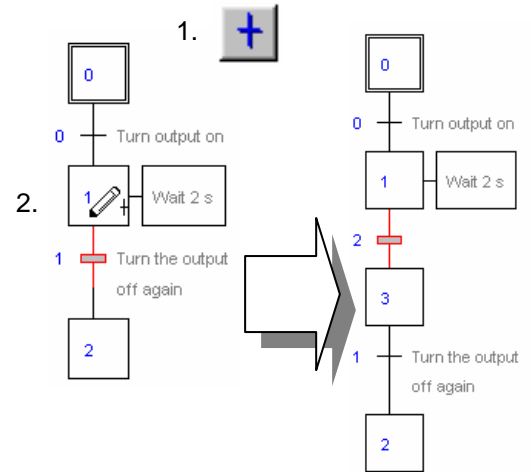

6.7.14 Delete a sequence

1. Activate the button *Select mode*
2. Click on the first transition of your sequence.
3. Click on the last step of the sequence you want to delete while holding the *Shift* key down.
4. Press the *Del* key.

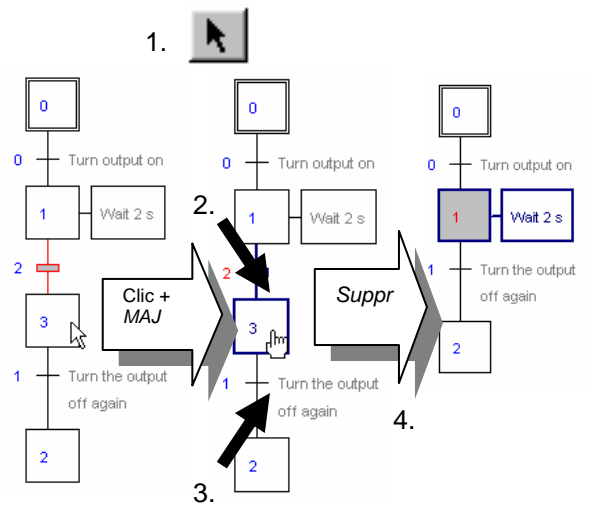

6.7.15 Copy-paste a sequence

Copy a sequence:

1. Activate the button *Select Mode*
2. Mark the start of sequence.
3. Mark the last step of the sequence while holding the *Shift* key down.
4. Select the menu *Edit, Copy*
5. Activate the button *Select mode*
6. Click on the point where you want to insert the sequence.
7. Select the menu *Edit, Paste*

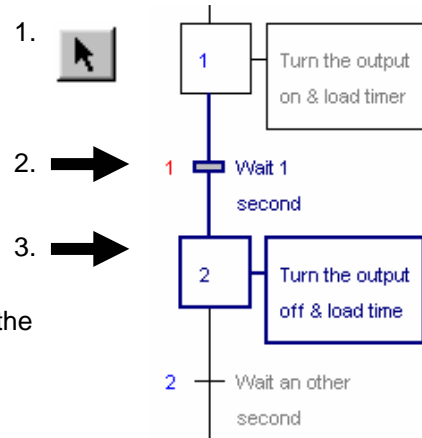

Past a sequence:

Remark:

Depending on the position of the element (transition or step) you select to insert, the sequence might be inserted underneath or beside the selected element.

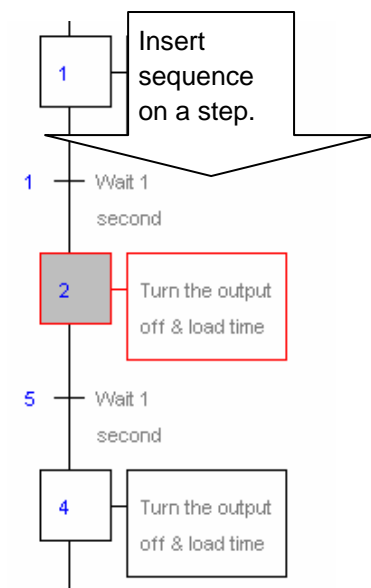
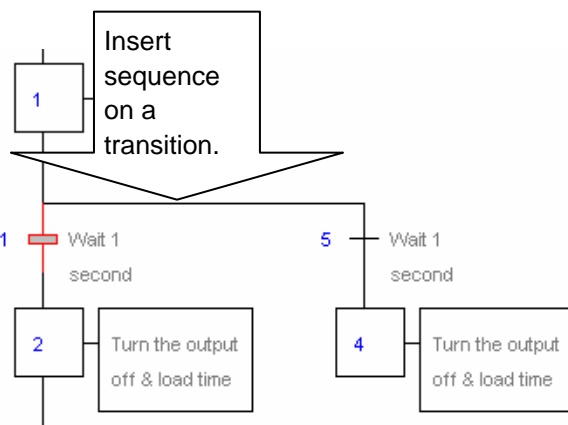
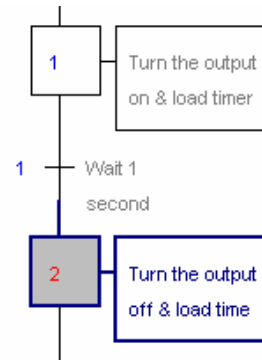
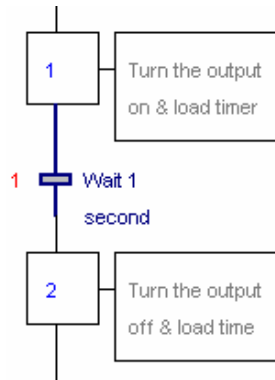
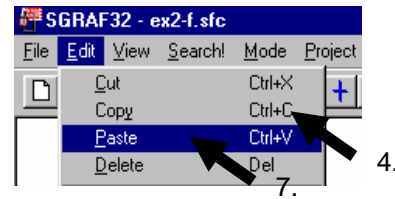

6.8 Write your first sequential block

6.8.1 Open the file

Open the file *PULSE.sfc*. Go to the SB list and load the SB called *PULSE*.

Goal:

We will write a program that makes a digital output (*Three_pulses* O 33) blink three times each time a digital input (*Start_3_pulses* I 2) goes high.

Diagram

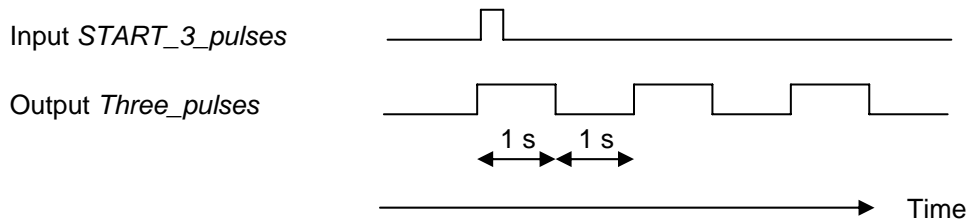

6.8.2 Draw the basic structure

We always start with an initial step: the starting point after a cold start. Once initialisation is complete, we can wait for the start signal: *Start_3_pulses*. Draw the elements as shown and add comments to the fields:

The screenshot shows a software interface with a ladder logic diagram on the left and an 'Element Properties' dialog box on the right. The diagram includes a timer block labeled ':0' with a comment 'Set the counter to 3' and a transition block labeled ':0' with a comment 'Wait for the start3_p signal'. The dialog box has the following fields and options:

- Name:** PULSE_TR_0
- Number:** (empty)
- Type:**
 - Step
 - Transition
 - Initial Step
 - Macro Step
 - SB
- Editor:** Function Block Diagram (with Edit and Delete buttons)
- Comment:** Wait for the \nstart3_p signal

When we start the sequence, we turn output *Three_pulses* on for 1 second. After one second, we turn the output off for another second. We do so three times and then we restart the sequence:

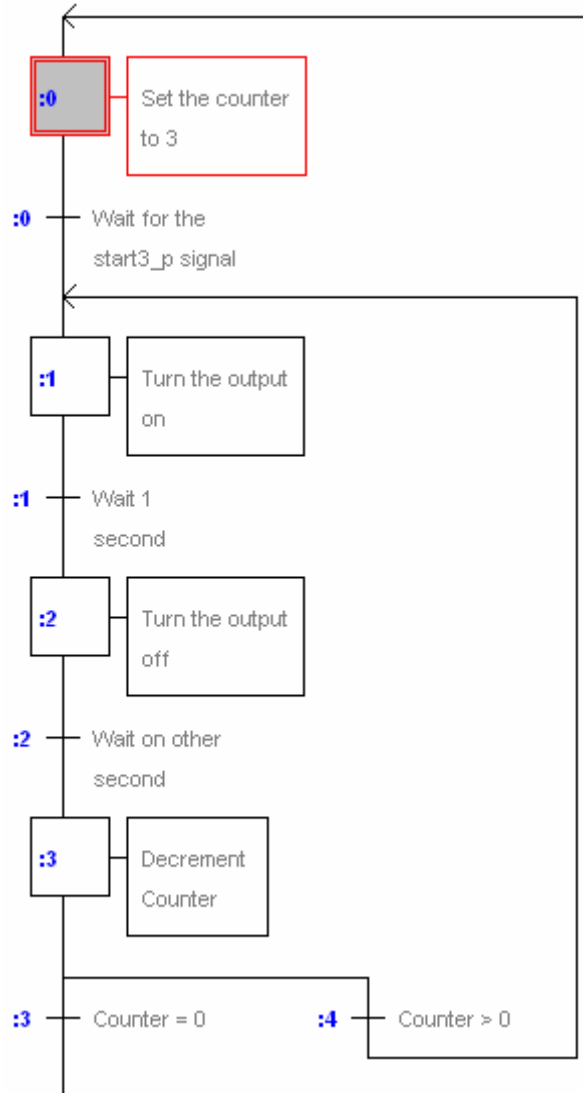

6.8.3 Choice the IL or Fupla editor

Our sequence is finished now. We only have to fill in the program code in each step and transition. We can edit each step and transition in instruction list or Fupla, whichever you prefer. We will program our initial step using the Fupla editor. Double-click on the initial step and choose the Fupla editor:

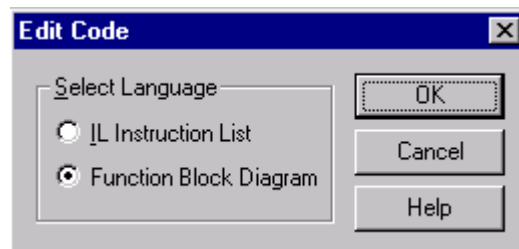

6.8.4 Prepare the symbols

First we will draw up a list with all the elements we are going to use in the symbol editor. Enter the elements as shown in the picture below.

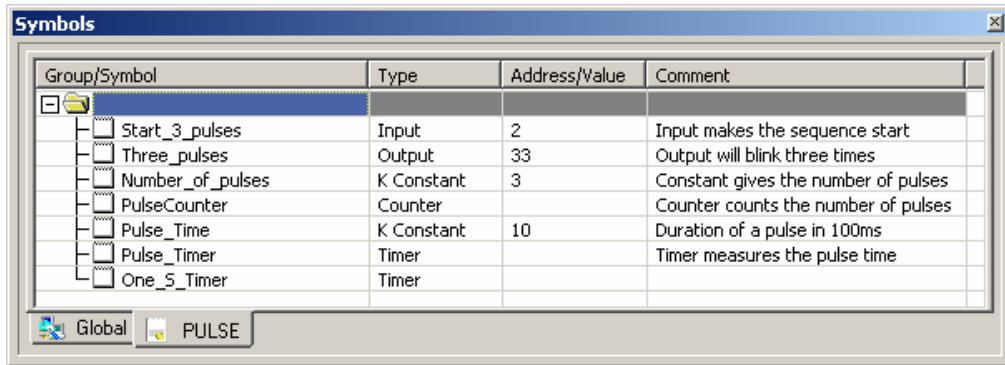

6.8.5 Edit the program code

Next load the counter *PulseCounter* with the constant *Number_of_pulses* equal to 3.

Fupla program:

Use the FBox: Graftec, Load counter

Remember, do not take counters or timers from the other families. They are designed to run in a cyclic program only.

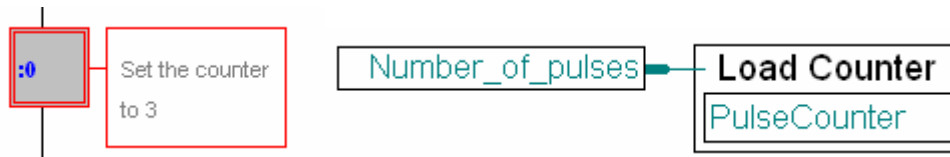

IL program:

```
LD PulseCounter ;Counter initialisation
Number_of_pulses
```

6.8.6 How to program a transition

A transition is repeated endlessly until the end of transition is active *ETR* (Fupla program) or the accumulator (instruction list program). In transition 0 we will wait inside the transition until the input *Start_3_pulses* goes high. Open transition 0 and add the program as shown below:

Fupla program:

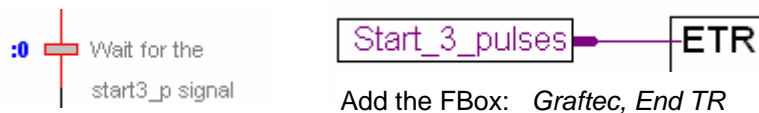

IL program:

```
STH Start_3_pulses ; Copy the information Start_3_pulses into the accu
```

6.8.7 Using timers in an SB

Proceed as follows: activate the output and load the timer into the step, then go to the wait transition, which polls the timer until the end of the delay (timer = 0).

Fupla program:

Timers and counters from the Fupla library are not designed for use in SBs. They are designed for COBs, which are executed cyclically over and over again. If you want to use timers or counters inside an SB, use the ones from the *Graftec* family. They are especially designed for sequential blocks, because you can load them in one step and query their state later on from another step or transition.

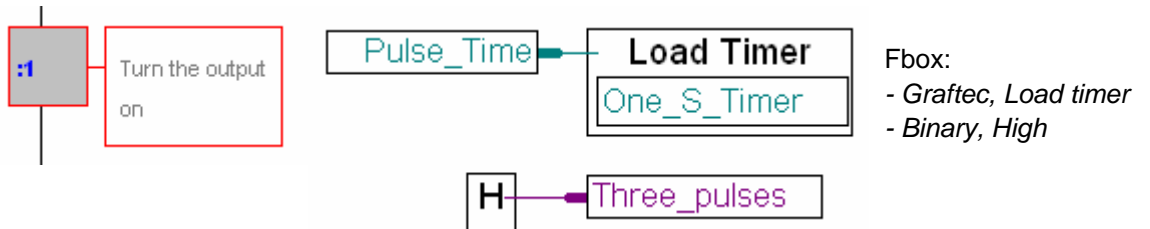

IL program:

```

SET      Three_pulses      ;Set the output high
LD       One_S_Timer       ;Load the timer
                Pulse_Time
    
```

6.8.8 Wait on the timer decrementation:

Fupla program:

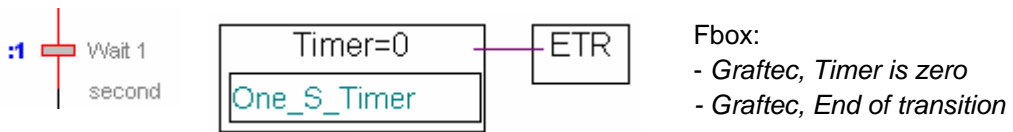

IL program:

```

STL     One_S_Timer       ;Set the accu high at the end
                                ;of the timer
    
```

6.8.9 Repeat the step and transition for the time were the pulse is off

The step 2 and transition 2 are the same as step1 and transition 1, except the output *Three_pulses* which is set low.

Fupla program:

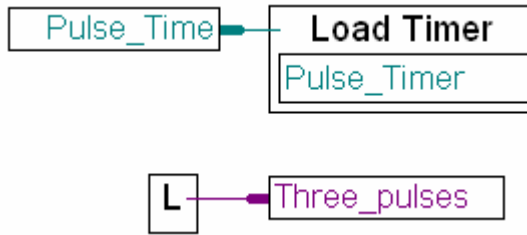
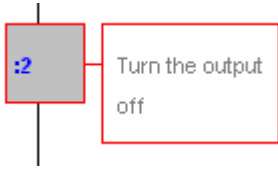

Fbox:
 - Graftec, Load timer
 - Binary, Low

IL program:

```
RES Three_pulses ;Set the output low
LD Pulse_Timer ;Load the timer
Pulse_Time
```

TR:

Fupla program:

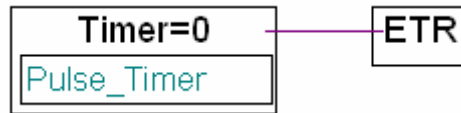
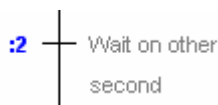

IL program:

```
STL Pulse_Timer ;Activates the accu when timing
;has ended
```

Note: Two different timers (*One_S_Timer* and *Pulse_Timer*) have been used for ST/TR 1 and 2. However, to save available timer addresses, we could just as well have used the same timer twice (*One_S_Timer* or *Pulse_Timer*) because they are not used simultaneously, but one after the other!

6.8.10 Decrement a counter

Fupla program:

The counter decrements with each program pass, but only if the binary input status is high (see online help on FBox).

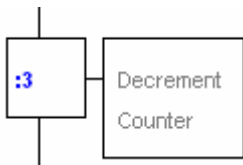

Fbox: Graftec, Decrement counter

IL program:

```
DEC PulseCounter ;If the accu is still at 1, decrement counter.
```

(N.B.: The accu is always at 1 at the start of an ST/TR)

6.8.11 Alternate branching

The last two transitions are then straightforward:

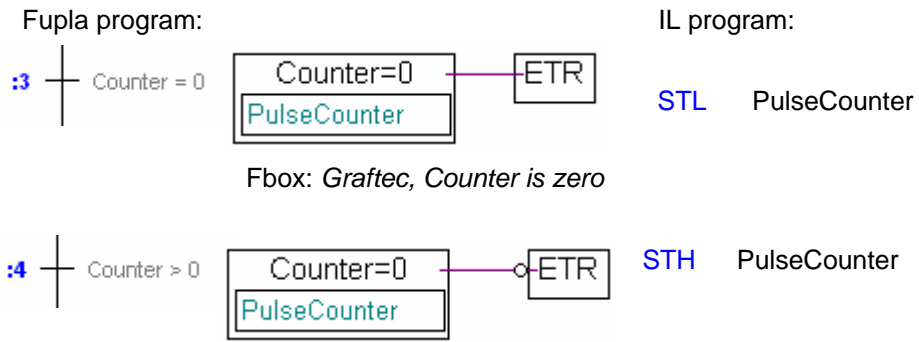

Transition 3: the input ETR is active if the counter value is zero.

Transition 4: the input ETR is active if the counter value is not zero.



Invert Binary connector

Put an inversion at the input of function *ETR* with button: *invert binary connector*.

6.9 Build and debug your program



Once you have finished the drawing, you can compile the entire program by clicking on the *Build* button.

Build All

6.9.1 Message Window

The message window will provide all the information you need.

If you have entered the program correctly, the message window will now report:

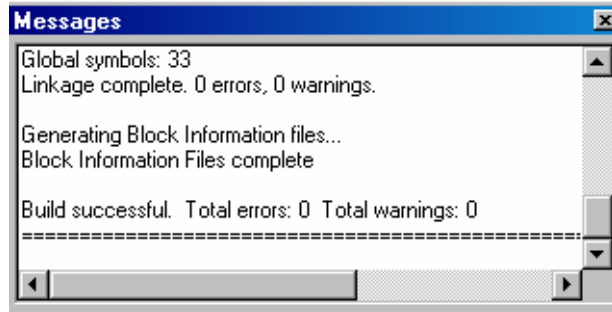

Build successful. Total errors: 0 Total warnings: 0

If there are any errors, they will be indicated in red text. Double-clicking on the error message will take you to the error.

6.9.2 Online tools

Now download the program and go online.



The sequential block can be observed online. The red spot always tells you which transition or step is active.

Download Program

6.10 Graftec structure with pages

6.10.1 Define a page

PG5 can keep big programs manageable by creating a simple overall structure, which then calls subpages.

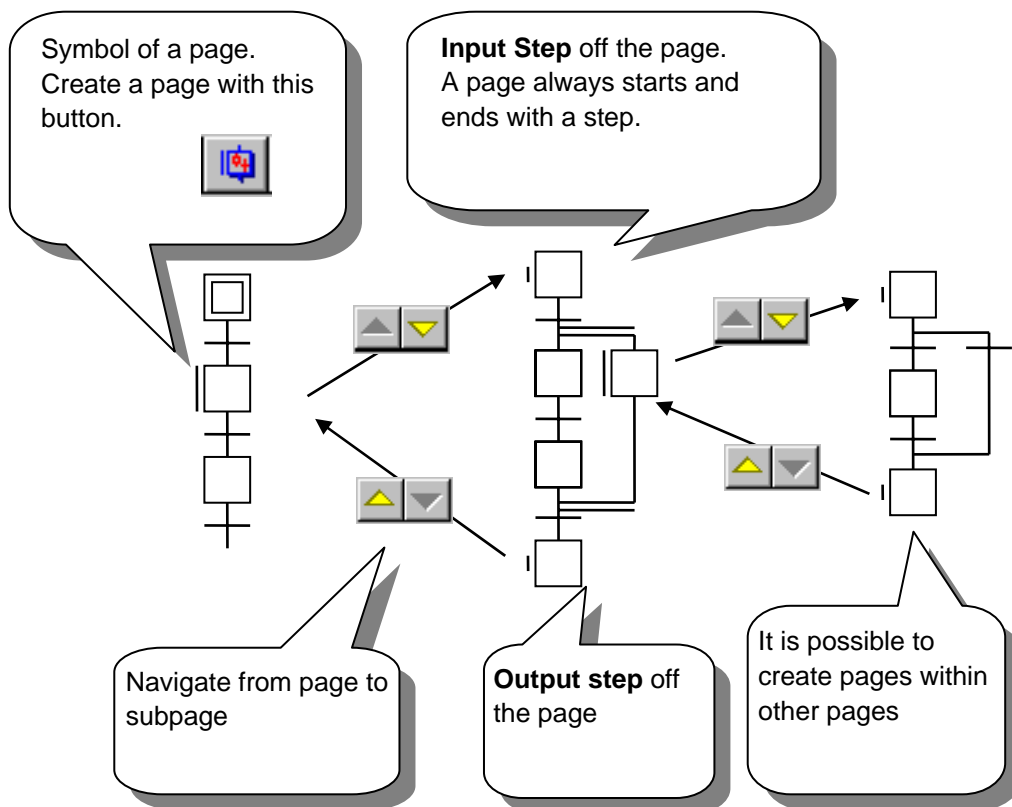

Roles while using pages:

A page always starts and ends with a step.

A page can have only one input step and only one output step.

You can have pages within pages (as many as you like).

You can neither move nor delete an "input/output step".

6.10.2 Edit a page

Create a page:

Let to create a page from a sequence.

1. Select the button *Select mode*
2. Click on the first step of your sequence.
3. Press the *Shift* key and click on the last step of your sequence.
4. Select the menu *Page, Create*.

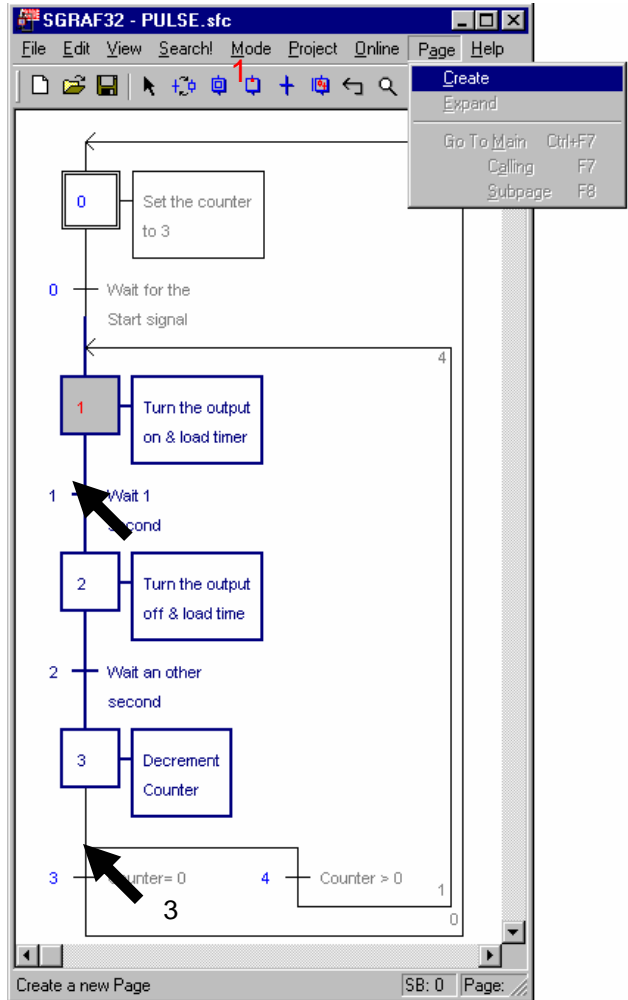

Open a page:

Display the content represented by the page symbol.

1. Select the button *Select mode*
2. Click with your mouse on the page.
3. Select the menu *Page, Subpage*

Supress a page:

Replace the symbol page by the whole sequence.

1. Select the button *Select mode*
2. Click with your mouse on the page.
3. Select the menu *Page, Expand*

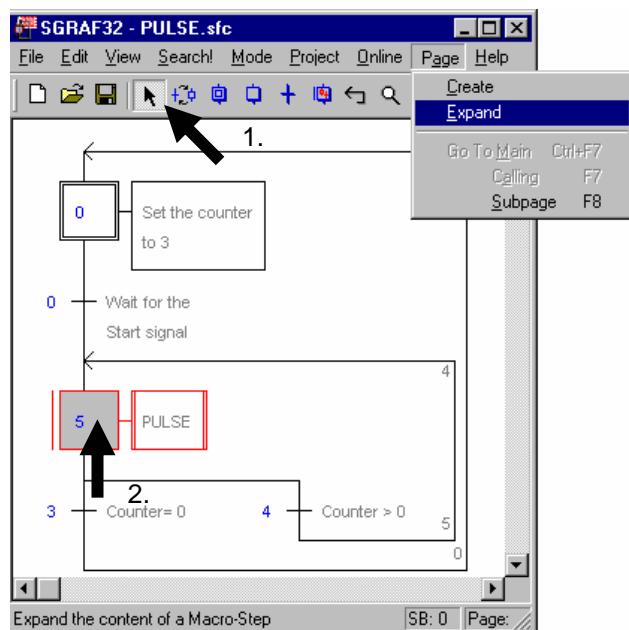

Note: The *Block Navigator* eases navigation between pages within any SB

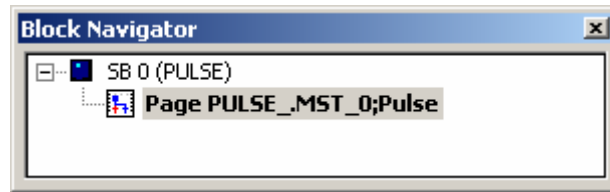

Contents

7	PROGRAMMING IN IL (INSTRUCTION LIST)	3
7.1	Chapter summary	3
7.2	Preparing an IL project	4
7.2.1	Create new project	4
7.2.2	Create new IL file	4
7.3	Organization of an IL edit window	5
7.3.1	Editing a line of code	6
7.3.2	Page format of instruction lines	7
7.3.3	Edit organization block	7
7.3.4	Sequence of processing for instructions and blocks	7
7.3.5	Rules to follow when editing blocks	8
7.4	Symbols window	9
7.4.1	Add new symbol to <i>Symbols</i> list	10
7.4.2	Operand addressing modes	11
7.4.3	Using a symbol from the <i>Symbols</i> list in an IL program	12
7.4.4	Local and global symbols	13
7.5	Introduction to the PCD instruction set	14
7.5.1	The accumulator	14
7.5.2	Binary instructions	15
7.5.3	Dynamisation	19
7.5.4	Status flags	20
7.5.5	Instruction words for timers	21
7.5.6	Instructions for counters	23
7.5.7	Accumulator-dependent instructions	24
7.5.8	Word instructions for integer arithmetic	25
7.5.9	Word instructions for floating-point arithmetic	26
7.5.10	Conversion of integer and floating-point registers	26
7.5.11	Index register	27
7.5.12	Program jumps	28
7.6	Editing a first application program	30
7.7	Building the program	32
7.8	Load program into PCD	33
7.9	Debugging a program	33
7.9.1	Viewing compiled code	33
7.9.2	Go On/Offline, Run and Stop	34
7.9.3	Step-by-step mode	35
7.9.4	Breakpoints	36
7.9.5	Online modification of the program	37
7.9.6	Viewing and modifying symbol states with the <i>Watch Window</i>	38
7.10	Commissioning an analogue module	39

7.10.1	Example for PCD2.W340 analogue input modules	39
7.10.2	Example for PCD2.W610 analogue output modules	40

7 Programming in IL (instruction list)

7.1 Chapter summary

The IL editor is the most flexible and powerful tool with which PCD controllers can be programmed. IL stands for instruction list: a non-graphical programming environment where the user writes programs with the help of the powerful PCD instruction set. All PCD controllers use this instruction set, thereby guaranteeing portability of programs from one PCD to another. The IL editor is more than just a valuable aid to program editing, it is also a diagnostic and on-line testing tool.

7.2 Preparing an IL project

Before producing an example, we recommend you prepare a new project and file in which to edit the IL program.

7.2.1 Create new project

In the SAIA Project Manager window, select menu *File, Project, New...* and create the new project.

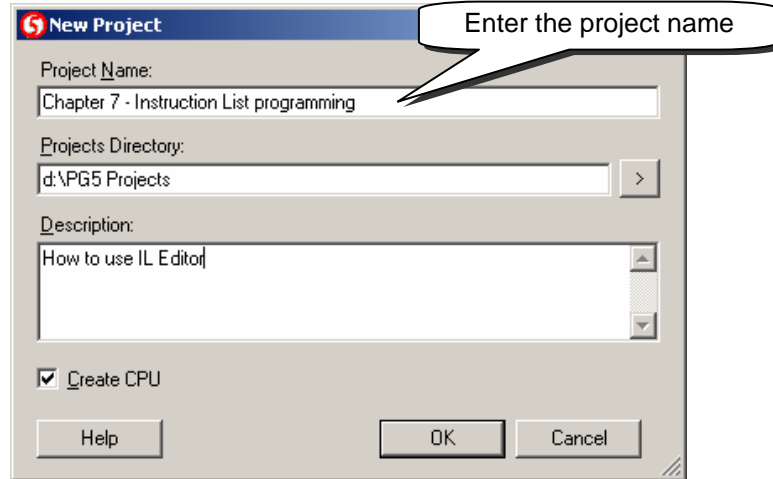

7.2.2 Create new IL file

To add a new program file to the project, select the folder *Program Files*, right-click with the mouse, and select menu *New...* (or press the *New File* button on the toolbar):

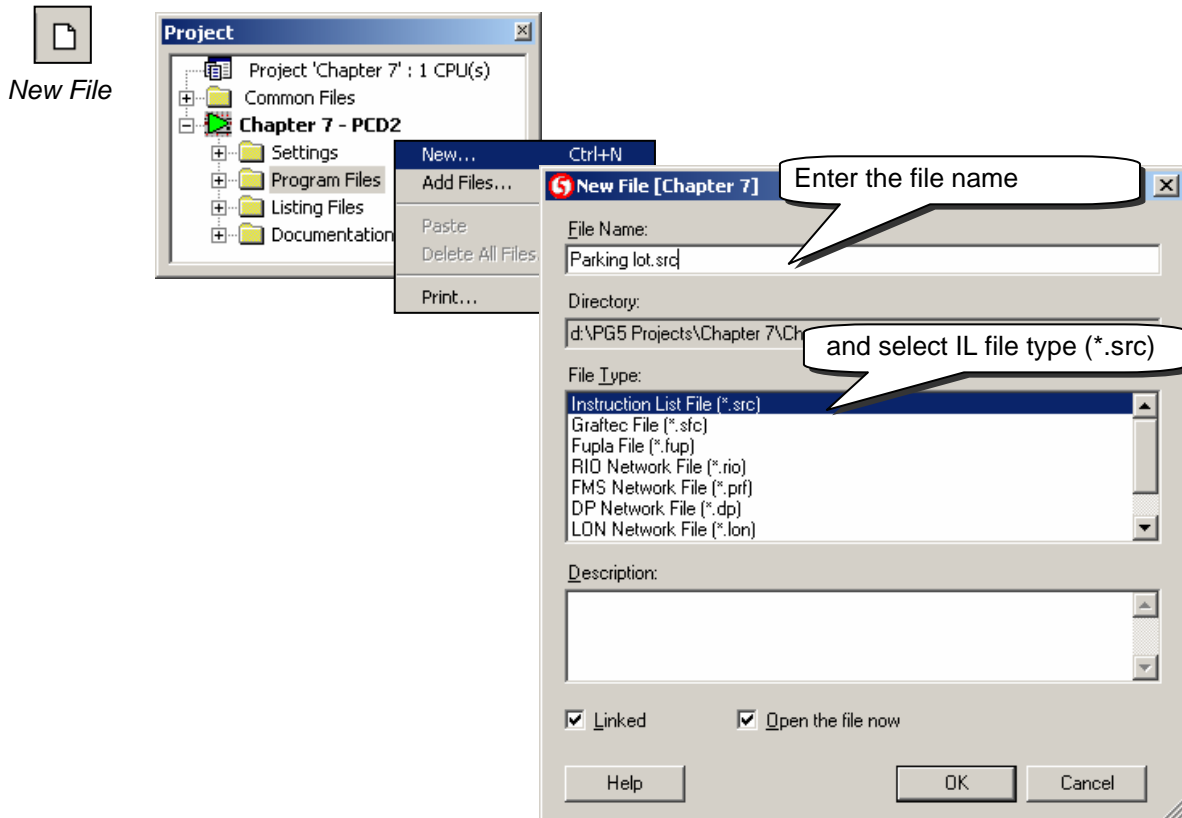

7.3 Organization of an IL edit window

Mnemonics

Labels	Operands	Comments
; Cyclical Organisation Block		
COB	0 0	; Cyclical program ; No supervision time
STH DYN DEC	Car_incoming Dynamise_incoming_car_signal Number_of_free_slots	; A car comes into the parking; ; On the positiv flank of incor ; Decrement the number of fre
STH DYN INC	Car_outgoing Dynamise_leaving_car_signal Number_of_free_slots	; A car leaves into the parking ; On the positiv flank of outgo ; Increment the number of fre
STL OUT	Number_of_free_slots Red_light	; If no more free parking slots ; Set the red light
ECOB		; End of Cyclical program

Group/Symbol	Type	Address...	Comment
Car_incoming	Input	0	Gets high when a car comes into the parking
Car_outgoing	Input	1	Gets high when a car leaves the parking
Red_light	Output	32	Stops new cars at the entry
Number_of_free_slots	Counter		Counts the number of free parking slots
Dynamise_incoming_car_signal	F		Flag detects the rising edge of the car incoming
Dynamise_leaving_car_signal	F		Flag detects the rising edge on the car leaving

Annotations: Start of COB, End of COB, Sequence of instruction processing within block

The IL editor is similar to any other commercial text editor. The same text functions are present, such as *Copy/Paste* or *Find/Replace*. However, the IL editor offers more than conventional text editing:

- Page layout specially adapted to writing PCD programs
- Colours enabling each type of information to be identified
- Symbols used by a program are listed in the *Symbols* window
- The program can be displayed visually on-line and tested step-by-step

7.3.1 Editing a line of code

Label	Mnemo.	Operand	Comment
	;Increment a register		
	STH	Flag	;Copy the Flag state into the accu
	DYN	DFlag	;On a positiv flank of the Flag , set the accu eigh
	JR	L Next	;If the accu is low, jump to the label Next
	INC	Register	; Increment the register
Next:	NOP		;No instruction

IL program lines are formatted into 4 columns:

Label

Represented by the colour red, the label is a symbol name for a program line. This is useful for program jumps. (JR L Next)

Mnemonic

Represented by the colour blue, the mnemonic - or program instruction - defines the operation to be performed on the operand: input, output, flag, register, ...

Operand

Represented by the colour black, the operand defines the data type: input, output, flag, register, ... and address.



View Symbols or Values

The *View Symbols or Values* button allows either the operand address or its symbol to be displayed.

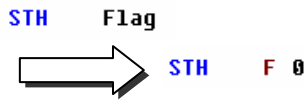

Comment

User comments are shown in green and begin with a semi-colon. They appear to the right of the mnemonic and operand, but may also occupy a whole line.

```

$SKIP
Author: Dupont Fred
Date: 28.10.2003
File: Logic.src
$ENDSKIP
    
```

If a comment extends to several lines, it is not always necessary to start each line with a semi-colon. Instead, the comment can be edited between two assembly instructions: \$skip and \$endskip. These tell the assembler to disregard all text which appears between them.



View User or Auto Comment

The *View User or Auto Comment* button can be used to view either the user comments attached to each line of the program, or the automatic comments attached to each symbol used as an operand.

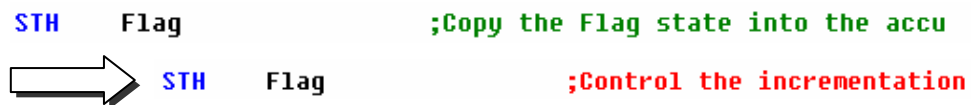

7.3.2 Page format of instruction lines

If the *Auto Format while Typing* option is selected, pressing the keyboard *Enter* key will automatically format each line of the program on the page. See menu *Tools, Options* in the IL editor. Column widths can also be configured.

If page formatting is not appropriate, it is also possible to mark a few lines, or all the lines in a file, with the mouse and reformat them with menu *Tools, Auto Format*.

7.3.3 Edit organization block

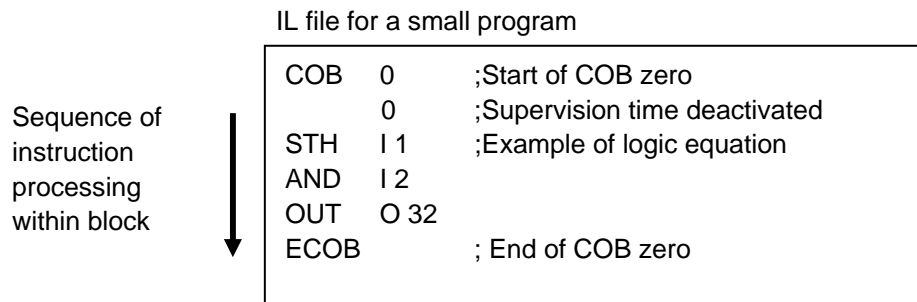

The SAIA PCD programming language is structured using organization blocks, in which the user writes application programs.

Each block provides a particular service: cyclical organization blocks (COB) for cyclical programs; sequential blocks (SB) for sequential programs, program blocks (PB) for subroutines; function blocks (FB) for subroutines with parameters; exception organization blocks (XOB) for exception routines.

Blocks are delimited by a start instruction and an end instruction. For example, the instruction COB marks the start of a cyclic organization block, which ends with the same instruction preceded by the letter E for "end" (ECOB). All program code belonging to this block must be placed between the instructions COB and ECOB, never outside the block.

Even the smallest PCD program will always have a COB. Other blocks may then be added as required.

7.3.4 Sequence of processing for instructions and blocks

Within each block, the PCD processes program instructions line by line, from the start instruction to the end-of-block instruction.

The order in which instruction lines are written within an organization block is important. However, the order in which the organization blocks themselves are written is not important. Different rules define the sequence of block processing:

In a PCD coldstart, the programmable controller first looks for XOB 16, the coldstart block. If it is present, it will always be processed first, regardless of whether it is at the beginning or end of the file.

Then, the machine looks for COBs in the program and processes them in numerical order: COB 0, COB 1, ... COB 15, regardless of the order in which they appear in the file. After the last COB, the program will start again from COB 0.

All the blocks for sequential programs (SB), subroutines (PB) and functions (FB) are called by the user program with the instructions CSB (Call SB), CPB (Call PB) and CFB (Call FB). The user program therefore determines when and in what order SBs, PBs and FBs are processed.

All exception blocks are automatically called as soon as the particular event concerned occurs. These events are unpredictable and may happen at any time. The order in which they are processed cannot be defined. Each hardware or software event is linked to a distinct XOB. These events cannot be modified by the user. However, the user is free to program which action to take within each of the XOBs.

7.3.5 Rules to follow when editing blocks

Even though blocks can be written in any order, the following rules must be followed:

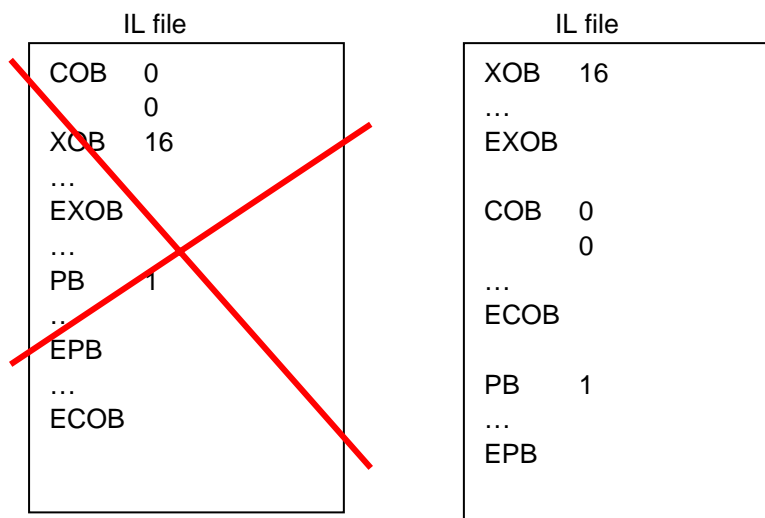

- Blocks cannot be written inside other blocks. They must always follow each other.
- No program instructions may be defined outside a block, with the exception of symbol definitions, texts and data blocks.

7.4 Symbols window



Show/Hide
Symbols Editor

Group/Symbol	Type	Address...	Comment
Car_incoming	Input	0	Gets high when a car comes into the parking
Car_outgoing	Input	1	Gets high when a car leaves the parking
Red_light	Output	32	Stops new cars at the entry
Number_of_free_slots	Counter		Counts the number of free parking slots
Dynamise_incoming_car_signal	F		Flag detects the rising edge of the car incoming
Dynamise_leaving_car_signal	F		Flag detects the rising edge on the car leaving

System Global Parking lot

The *Symbols* window contains a list of all operands in a program. It can be viewed with the *Show/Hide Symbol Editor* button, or via the menu command *View/Symbol Editor*. Each line defines all the information relative to an operand and constitutes a symbol:

Symbol

A symbol is a name that indicates the address of an input, output, flag, register,... It is advisable to use symbol names when editing a program, rather than the direct address of a flag or register. This allows correction of an address or data type from the *Symbols* window. Instead of having to copy the correction to each line of the program, it is only necessary to correct it in the *Symbols* window. There is no risk of forgetting to correct a line in the program and creating an error that is hard to find.

Syntax for symbol names

The first character is always a letter, followed by other letters, numbers, or the underscore character. Avoid accented characters (ö,è,ç,...).

Differences of case (upper or lower) have no significance: MotorOn and MOTORON are the same symbol.

Type

Defines operand type: input (I), output (O), register (R), counter (C), timer (T), text (X), DB, ...

Address

Each operand type has its own range of available addresses:

Inputs and outputs:	dependent on I/O modules inserted in PC
Flags:	F 0, ..., F 8191
Registers:	R 0, ..., R 4095
Timers/counters:	T/C 0, ..., T/C 1599
...	

Comment

The comment is linked to the symbol and can be viewed instead of the user comment linked to each line of program code.

Toggle with the button *View User* or *Auto Comment*.





View User or
Auto Comment

STH	Flag	;Copy the Flag state into the accu
	STH	Flag
		;Control the incrementation

7.4.2 Operand addressing modes



A symbol definition does not necessarily include all the information presented below. We distinguish between three types of addressing:

Absolute addresses

Group/Symbol	Type	Address/Value	Comment
 	Output	32	Stops new cars



The data is defined only with a type and address (e.g. 32), and an optional comment. Using absolute addressing directly in the program is a disadvantage when changing the type or address. The user program will not be updated by changes made in the symbol list. Changes must be made manually for each line of a program. It is therefore preferable to use symbol names, with optional dynamic addressing.

Symbol names

Group/Symbol	Type	Address/Value	Comment
  red_light	Output	32	Stops new cars

The data is defined with a symbol name, type, address and optional comment. Correction of symbol, type or address is supported from the symbol list and each user program line automatically updated if the symbol is changed.

Dynamic addressing

Group/Symbol	Type	Address/Value	Comment
  red_light	F		Stops new cars

This is a form of symbolic addressing in which the address is not defined. The address is assigned automatically during the program build. The address is taken from an address range defined by the *Software Settings*. (See Project Manager.)

N.B.: Dynamic addressing is available with flags, counters, timers, registers, texts, DBs, COBs, PBs, FBs and SBs. However, absolute addresses must always be defined for inputs, outputs and XOBs.

7.4.3 Using a symbol from the *Symbols* list in an IL program

When a program is edited, symbols already defined in the *Symbols* window may be used in different ways:

Symbol entry from the keyboard

The symbol name is entered in full from the keyboard for each instruction that uses it. This method might allow a symbol name to be edited with a typing error, which would only become evident when the program was built.

Symbol entry by selective searching

Group/Symbol	Type	Address...	Comment
Car_incoming	Input	0	Gets high when a
Car_outgoing	Input	1	Gets high when a
Red_light	Output	32	Stops new cars a
Number_of_free_slots	Counter		Counts the numb
Dynamise_incoming_car_signal	F		Flag detects the
Dynamise_leaving_car_			detects the

Ctrl + Space

sth Dyn

Choose a Symbol
 Dynamise_incoming_car_signal F ;Flag
 Dynamise_leaving_car_signal F ;Flag d

↑, ↓, Enter

⇒ DYN Dynamise_leaving_car_signal

If only the first few characters of the symbol name are entered from the keyboard, pressing the *Ctrl+Space* keys at the same time displays a window showing a list of all the symbols which start with the letters which have been typed. The required symbol can then be selected either with the mouse or the keyboard arrow keys (↑, ↓) and confirmed by pressing *Enter*.

Symbol entry by drag-and-drop

Position mouse cursor on symbol, press left mouse button and hold down.

Group	Type	Address/...	Comment
DynamiseCar_Leaving	F		Flag detect...

sth

Drag mouse cursor into IL editor

⇒ sth DynamiseCar_Leaving

Release mouse button

This way of using a symbol excludes any possibility of typing errors. In the *Symbols* window, position the mouse cursor on the definition line of a symbol, press the left mouse button and keep it down. Drag the mouse cursor into the IL editor and release the mouse button. The symbol chosen is automatically added at the place indicated by the mouse cursor.

7.4.4 Local and global symbols

The symbol definition window has two folders : *Global* and *Local*



Definition

Local symbols appear in a folder that bears the name of the file using them. These symbols may only be used within that file. (*Parking lot.src*)

The global symbols that appear in the *Global* folder may be used by all files in the CPU. (*Parking lot.src* and *Ventilation.src*)

Make Local/Global

If necessary, symbols in the *Symbols* window can be moved from the local folder to the global folder, and vice versa.

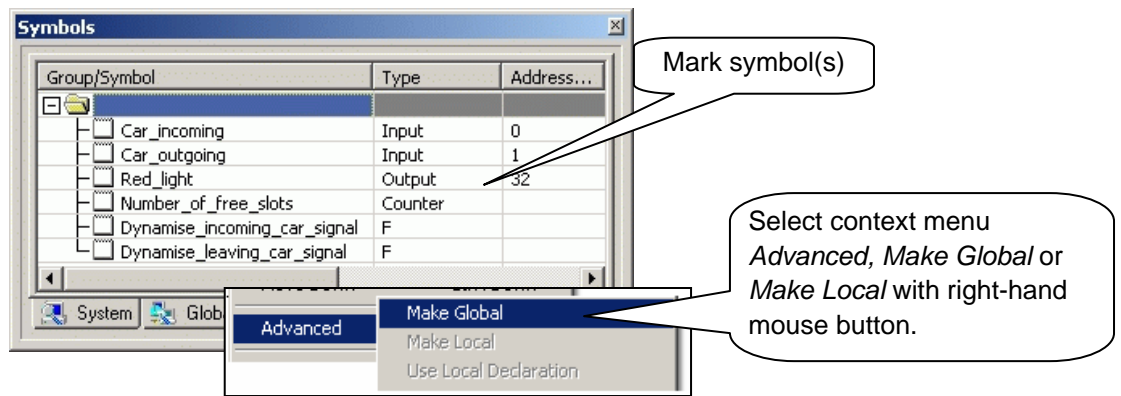

The symbol is moved into the *Global* or *Local* folder

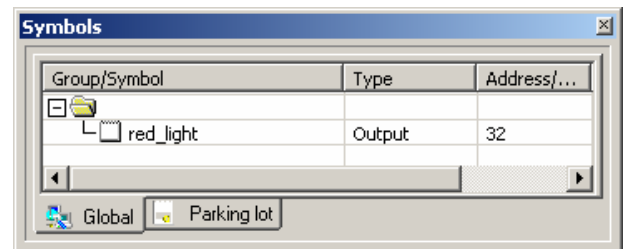

Any new symbol defined directly from the IL editor will be added either to the global or local folder, depending on settings in the *Global symbols* option. See context menu *Advanced, Options, Add symbols to Global table* of the *Symbols* window.

7.5 Introduction to the PCD instruction set

This section provides an overview of the PCD instruction set. For more detailed information, consult the full description of each instruction given in the manual *Guide to instructions 26/733* or in PG5 help screens. To obtain specific help about an instruction from the IL editor: write the instruction, put the cursor on it and press key *F1*. General help is also available with the menu *Help, Instruction List Help*.

7.5.1 The accumulator

The accumulator is a binary value whose value is set by binary instructions and a few integer instructions. The PCD has just one accumulator, which may be considered as a special kind of flag. The state of the accumulator can be forced with the *ACC* instruction. The *ACC* instruction also allows the accumulator to be forced with the value of a status flag (see description of status flags).

Examples:

ACC H

Forces accumulator state high

ACC L

Forces accumulator state low

ACC C

Inverts (complements) accumulator state

7.5.2 Binary instructions

Binary instructions use operands that may have just one of two distinct states: 0 or 1 (low or high). These instructions are used to perform binary equations with the states of PCD inputs, outputs, flags, counters and timers.

Binary instructions always involve the accumulator. Some binary instructions affect the state of the accumulator:

Examples:

ACC H
Forces accumulator state high

ACC L
Forces accumulator state low

STH I 4
Copies state at input 4 to accumulator.
The accumulator state will be high if 24 volts are applied to input 4.
The accumulator state will be low if zero volts are applied to input 4.

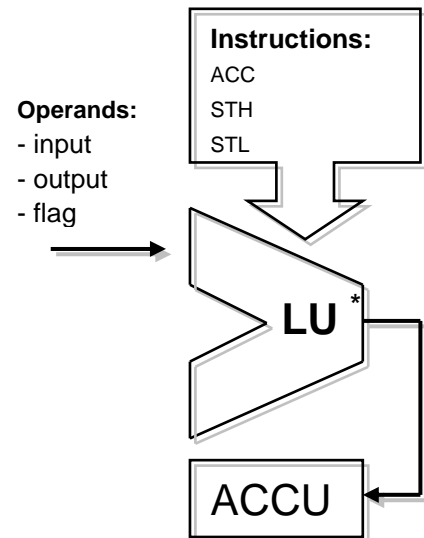

Other instructions read the state of the accumulator to execute a binary function and put the result back into the accumulator:

Examples:

ANH I 5
Reads accumulator state and executes logical AND function with state of input 5. The accumulator is set to the result.

ORH F 100
Reads accumulator state and executes logical OR function with the state of flag 100. The accumulator is set to the result.

XOR T 3
Reads accumulator state and executes logical XOR function with the state of timer 3. The accumulator is set to the result.

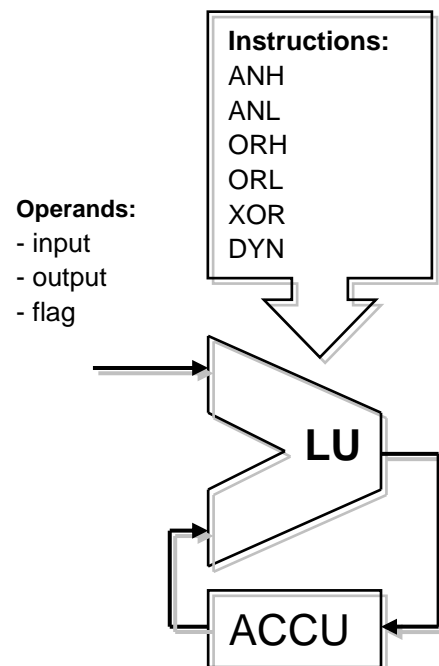

The result of any binary equation is always saved in the accumulator. The *OUT* instruction allows the content of the accumulator to be copied to an output or flag:

Example:
OUT O 32
 Copies accumulator state to output 32.
 If accumulator state is high, 24 volts will be applied to output 32.
 If accumulator state is low, zero volts will be applied to output 32.

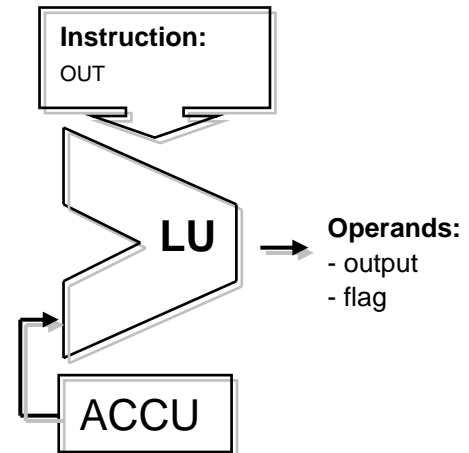

Example: programming a simple binary equation

This example of a program performs the binary equation: $O32 = I0 * I1 + I2 + I3 * I4 * I5$
 It may also be represented by the following diagram :

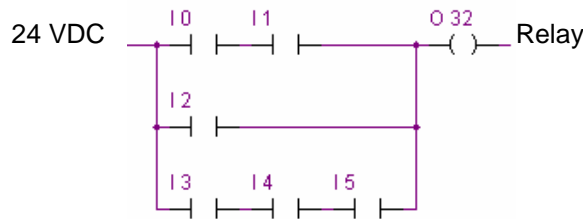

A binary equation always starts with a *STH* or *STL* instruction, which will then be followed by the necessary *ANH* (*), *ORH* (+), *XOR* functions.

Note that the *ORH* instruction has priority over *ANH*. Each *ORH* instruction marks the start of a new line of contacts in the above diagram. The partial or final result of a binary equation is always put in the accumulator. The *OUT* instruction enables the accumulator result to be used to modify the state of an output or flag.

```

COB  0           ;Start of cyclic program
      0
STH  I 0         ;Copies state of input I 0 to accumulator: Accu
= I0
ANH  I 1         ;AND function between state of accumulator
and input 1:Accu = I0*I1
ORH  I 2         ;OR function between state of accumulator
and input 2:Accu= I0*I1+I2
ORH  I 3         ; Accu = I0*I1+I2+I3
ANH  I 4         ; Accu = I0*I1+I2+I3*I4
ANH  I 5         ; Accu = I0*I1+I2+I3*I4*I5
OUT  O 32        ;Copies result of equation present in
accumulator to output
ECOB            ;End of cyclic program
    
```

Example: programming a binary equation with a changed order of evaluation

This example of a program performs the binary equation : $O33 = (I1 * I2 + I4) * I3$
 It may also be represented by the following diagram :

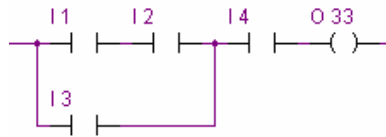

It is sometimes necessary to change the order of priority of binary functions. Generally, we do this by putting brackets into the equations. However, the PCD instruction set does not include brackets. The equation must therefore be divided into two smaller equations. The first equation works out the result of the bracketed part and saves it temporarily to a flag, while the second equation takes the interim result saved on the flag and calculates the final result.

```

COB  0
      0
STH  I 1           ;First equation
ANH  I 2
ORH  I 4
OUT  F 0           ;Result of bracketed function: F0 =(I1*I2+I4)

STH  F 0           ;Second equation
ANH  I 3
OUT  O 33          ;Final result : O 33 = F0*I3
ECOB
    
```

Other binary instructions also allow the accumulator to be used to modify the state of an output or flag. Each instruction supports a different function.

Example:

SET O 32
 If accumulator state is high, output 32 will be forced high. Otherwise the output will remain in its current state.

RES O 32
 If accumulator state is high, output 32 will be forced low. Otherwise the output will remain in its current state.

COM O 33
 If accumulator state is high, output 33 will be inverted high. Otherwise the output will remain in its current state.

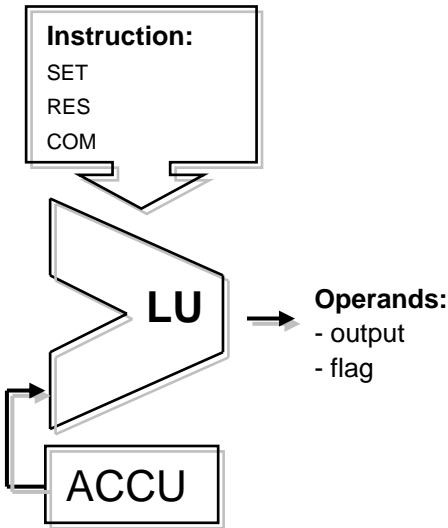

Example:

This example shows differences between the instructions OUT, SET, RES, and COM

```
COB  0
      0
STH  I 0
OUT  O 32 ; Copy I 0 to O 32
```

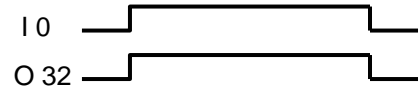

```
STH  I 0
SET  O 33 ; Save high state to output 33

STH  I 1
RES  O 33 ; Save low state to output 33
```

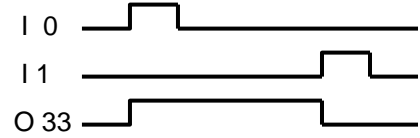

```
STH  I 0 ; On rising flank of I 0
DYN  F 1
COM  O 34 ; Invert state of output 34
ECOB
```

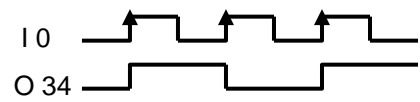

Some binary instructions end with the letter H or L. Instructions that end with L will invert the state of any information before performing their function.

Examples:

STH I 4
Copies state of input 4 to accumulator. Accumulator state is high if 24 volts are applied to input 4.

STL I 4
Copies inverse state of input 4 to accumulator. Accumulator state is low if 24 volts are applied to input 4.

ANH I 5
Performs a logical AND function between the accumulator state and the state of input 5.

ANL I 5
Performs a logical AND function between the accumulator state and the inverse state of input 5.

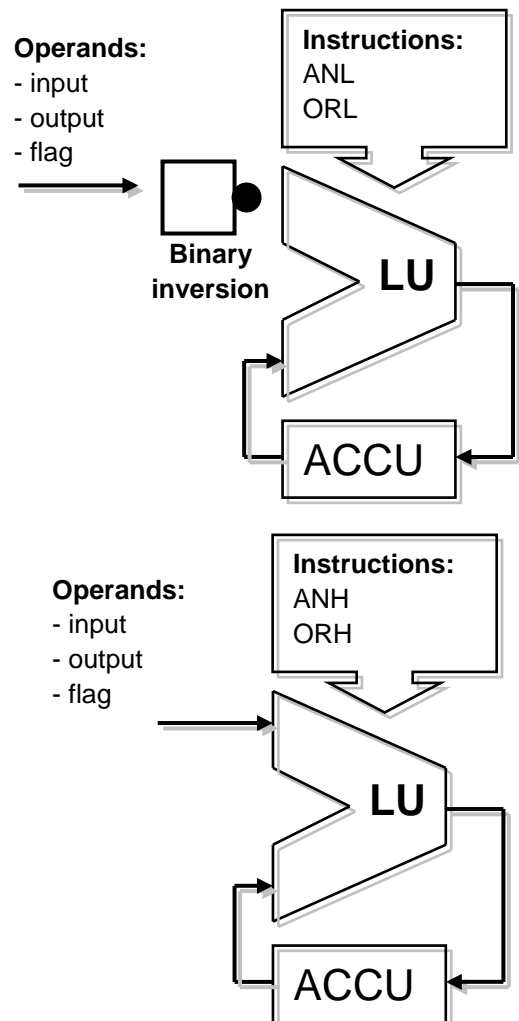

7.5.3 Dynamisation

Binary instructions generally use the low or high binary state to perform a binary function or modify the state of an output or flag.

Sometimes it is not the low or high binary state that interests us, but the passage from a low state to a high state (e.g. to increment a counter).

To detect a rising edge, proceed as follows: place the result of a binary equation in the accumulator and use the *DYN* instruction to find the positive change. After the *DYN* instruction, the accumulator state will be high if a positive change has been detected, otherwise it will be low. The flag used by the *DYN* instruction may only be used for a single dynamisation instruction. This is because it is used to conserve the state for the next program cycle.

Example:

detection of a rising edge

```

STH  I 0
DYN  F 3
COM  O 34
    
```

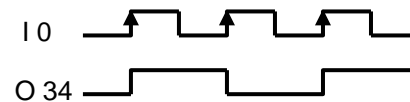

Example:

detection of a falling edge

```

STL  I 0
DYN  F 3
COM  O 34
    
```

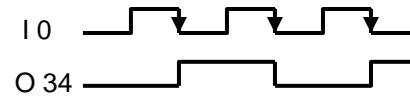

To help you see the influence of the *DYN* instruction on the program shown above, we suggest you remove the *DYN* instruction and observe how the program behaves.

7.5.5 Instruction words for timers

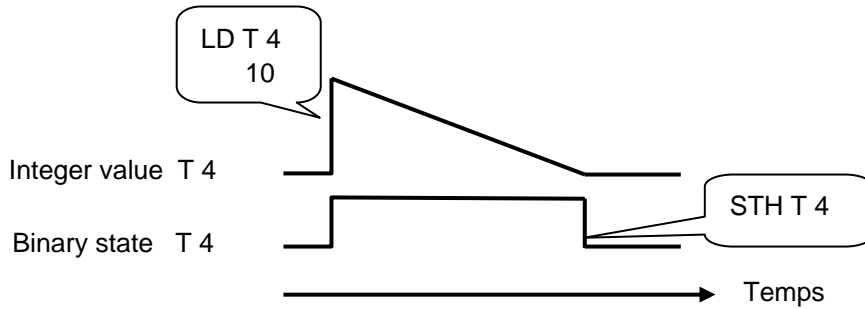

Timers contain two values: the integer delay time value and the timer's binary state. To implement a delay time, load the time value as a positive integer that will determine the length of the delay time in tenths of a second¹. The controller will automatically decrement the time value until it reaches zero. The timer's binary state is high while the time value is decrementing, and goes low when the time value reaches zero.

<p>Loading a delay time</p> <p>LD T 4</p> <p>If the accumulator state is high, timer T 4 will be loaded with a constant of 10. Otherwise the timer will keep its current value.</p>	<p>Reading the state of the timer</p> <p>Use a binary instruction, such as:</p> <p>STH T 4 , ANH T 4, ORH T 4, ...</p>
--	---

Example:

Send a one second pulse to output 36 for each rising edge at input 2

State diagram:

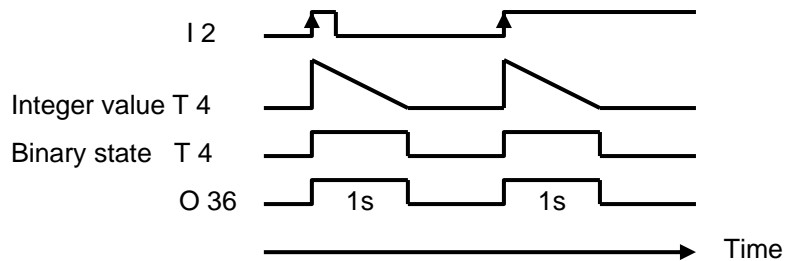

Corresponding program:

```

COB 0
      0
STH I 2           ;Detection of rising edge at input 2 ...
DYN F 2           ;...sets accu state high
LD T 4           ;If accu is high, load time delay for 10 units of
time 10
STH T 4           ;Copy logical state of time delay to output 36
OUT O 36
ECOB
    
```

¹ A time base other than 1/10th of a second (default value) can also be set. This can be done from the *Software Settings*.

Example:

Send a one-second pulse to output 37 with a 5 second delay for each rising edge at input 3

State diagram:

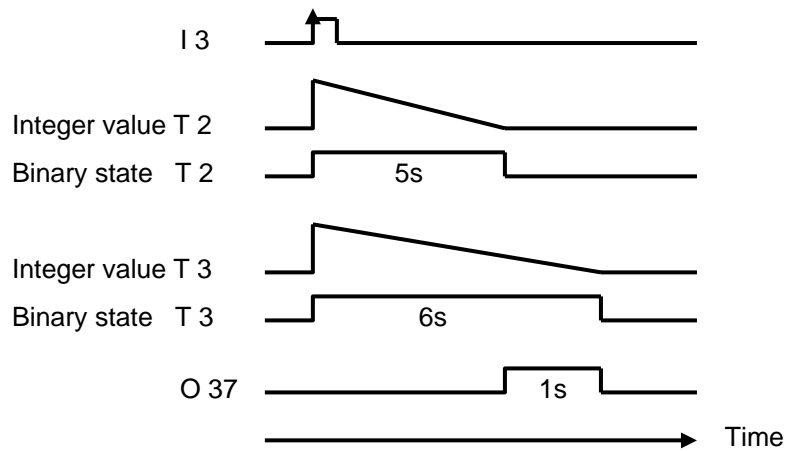

Corresponding program:

```

COB  0
      0
STH  I 3
DYN  F 3
LD   T 2
      50
LD   T 3
      60
STH  T 2
XOR  T 3
OUT  O 37
ECOB

```

7.5.6 Instructions for counters

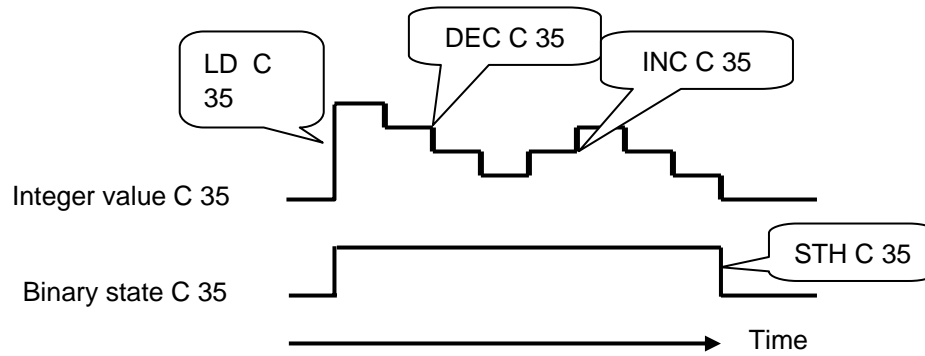

Like timers, counters also have two values: the integer count value and the binary state of the counter.

To implement counting, load the counter with a positive integer value.

Unlike timers, counters are only incremented or decremented by instructions in the user program. The counter's binary state is high when the count value is greater than zero and goes low when the count value reaches zero.

<p>Loading a counter LD C 35 10 If accumulator state is high, counter 35 will be loaded with a constant of 10. Otherwise the counter will keep its current value.</p>	<p>Reading the state of a counter Use a binary instruction, such as: STH C 35, ANH C 35, ORH C 35, ...</p>
<p>Incrementing a counter INC C 35 If accumulator state is high, counter 35 will increment by one unit. Otherwise the counter will keep its current value.</p>	<p>Decrementing a counter DEC C 35 If accumulator state is high, counter 35 will decrement by one unit. Otherwise the counter will keep its current value.</p>

Status flags

Instructions INC and DEC counter modify the status flags depending on the result of the operation (**Positive**, **Negatif**, **Zero**, **Error**).

Example: Counting pulses from a binary input with a counter.

```

COB 0
      0
STH I 2 ; Copy input state to accumulator
DYN F 3 ; Force accu state high at positive edge of I 2
INC C 35 ; If accu state is high, increment counter
ECOB
```

Instructions *STH* and *DYN* read information from input 2 and set the accu state high for a rising edge or low in the absence of an edge. Depending on the accu state, the *INC* instruction will increment counter 35.

7.5.7 Accumulator-dependent instructions

We have seen that binary instructions make much use of the accumulator, and that some word instructions also use it.

But not all instructions use the accumulator in the same way. There are 7 instructions which use it in a special way. These are the accumulator-dependent instructions. They are only processed if the accumulator has previously been set high. The accumulator state is therefore a determining condition.

The 7 accumulator-dependent instructions are listed below :

SET	
RES	
COM	
LD	Only for timers and counters
LDL	Only for timers and counters
INC	Only for timers and counters
DEC	Only for timers and counters

Example:

Create a time base that inverts an output once every second.

This example uses three instructions. The first (*STL*) uses the accumulator to put in it the timer's inverse state. The following two (*LD* and *COM*) depend on the accumulator. They will only load the time base and invert the output if the accumulator has previously been set high by the instruction *STL*.

```

COB  0
      0
STL  T 1 ;If the timer state is low, the accumulator state will be high
LD   T 1 ; load time delay with 10 units of time
      10
COM  O 38 ; invert output state
ECOB

```

7.5.8 Word instructions for integer arithmetic

These instructions are used for calculating arithmetical equations using integer format registers and constants. Each arithmetical instruction has several lines and applies operands to registers or constants, but the result will always be placed in a register.

Addition	Subtraction	Square root
ADD R 0 R 1 R 3 ;R3=R0+R1	SUB R 0 K 18 R 3 ;R3=R0- 18	SQR R 100 R 101
Multiplication	Division	Comparison
MUL K 5 R 1 R 3 ;R3=5*R1	DIV R 0 R 1 R 3 ;R3=R0/R1 R 4 ;Reste	CMP R 0 R 1
Increment	Decrement	Initialize register
INC R 0 ;R0= R0+1	INC R 0 ;R0= R0+1	LD R 0 K 19 ; R 0 = 19

Status flags

All the above arithmetical instructions modify status flags according to the result of the operation (**Positive**, **Negatif**, **Zero**, **Error**), with the exception of the instruction for loading a register with a constant (LD).

Differences between registers and timers/counters

Unlike counters, the instructions for loading a constant into a register, incrementing a register or decrementing a register are not dependent on accumulator state. The register value to be incremented or decremented may be either a positive or negative integer.

Example:

Compare the contents of two registers and switch on three outputs, according to the following conditions:

Registers	O 32	O 33	O 34
R 0 > R 1	High	Low	Low
R 0 = R 1	Low	High	Low
R 0 < R 1	Low	Low	High

The compare instruction does a subtraction R 0 – R 1 and sets status flags according to the result:

Registers	P	N	Z	E
R 0 > R 1	1	0	0	0
R 0 = R 1	1	0	1	0
R 0 < R 1	0	1	0	0

```
CMP R 0 ;Perform subtraction R 0 – R 1, status flags
will be
R 1 ; modified according to result of subtraction
ACC P
OUT O 32 ; R 0 > R 1
```



```

ACC  Z
OUT  0 33                ; R 0 = R 1
ACC  N
OUT  0 34 ;R 0 < R 1

```

7.5.9 Word instructions for floating-point arithmetic

These instructions are used for calculating arithmetical equations using floating-point format registers and constants. Each arithmetical instruction starts with the letter F to indicate that it's a floating-point instruction. The operands of these instructions are always registers, never constants. If a constant is needed, it must be loaded into a register and then the register can be used in the floating-point instruction.

Addition	Subtraction	Square root
FADD R 0 R 1 R 3 ;R3=R0+R1	FSUB R 0 R 1 R 3 ;R3=R0-R1	FSQR R 100 R 101 ;result
Multiplication	Division	Comparison
FMUL R 0 R 1 R 3 ;R3=R0*R1	FDIV R 0 R 1 R 3 ;R3=R0/R1	FCMP R 0 R 1
Sine	Cosine	Arc tangent
FSIN R 10 R 11 ;result	FCOS R 10 R 11 ;result	FATAN R 10 R 11 ;result
Exponent	Natural logarithm	Absolute value
FEXP R 20 R 21 ;result	FLN R 20 R 21 ;result	FABS R 30 R 31 ;result

Status flags

All the above instructions modify the status flags, with the exception of the *LD* instruction for loading a floating-point format constant.

Initialize a register
LD R 0 3.1415E0 ; R 0 = PI

7.5.10 Conversion of integer and floating-point registers

The PCD has separate instructions for arithmetical operations on integers and floating-point numbers. If an application program has to add or multiply two registers, one containing an integer and the other a floating-point number, it is necessary to convert the registers either to integer or floating-point, before performing the arithmetical operation.

Convert integer-fltg point	Convert fltg point-integer
IFP R 0 ; integer -> float 0 ; exponent	FPI R 0 ;float ->integer 0 ; exponent

7.5.11 Index register

Each COB has a rather special register: the index register. The content of the index register can be checked with the following instructions:

SEI K 10	SEt Index register	Loads the index register with a constant of 10
INI K 99	IN crement Index register	Increments the index register and sets accu state high as long as: Index register <= K 99
DEI K 5	DE crement Index register	Decrements the index register and sets accu state high as long as: Index register >= K 5
STI R 0	ST ore Index register	Copies index register to register 0
RSI R 0	Re Store Index register	Copies register 0 to index register

Many PCD instructions support the use of the index register. This register allows indirect addressing of registers, flags, inputs, outputs, timers etc, used by instructions in the program. These instructions are the same as those normally used, but have an additional letter X.

Example:

Registers are non-volatile memory. This means they keep their information when the power supply is cut or if there is a cold-start. If we wish to make a range of 100 registers volatile, we would have to initialise these 100 registers with a value of zero during a cold-start. To initialise a register with zero, we can use the following instruction:

```
LD    R 10
      K 0
```

If we have 100 registers (R 10 to 109) to initialise, we would have to write this instruction 100 times, changing the register address each time. That would be rather tedious to do.

Another solution would be to initialise the index register with an index of zero and implement a program loop to load the first register with zero, incrementing the index. Therefore, for each loop, we load zero into a different register (R 10, R 11,.... R 109). At the 100th loop, the index counter reaches the maximum index value (K 99) and forces the accumulator state low. This allows the loop to be exited so that the rest of the program can be processed.

```

      XOB          16          ;Cold-start block
      SEI          K 0          ;Index = 0
LOOP: LDX          R 10          ;Load register address = 10 +
index
                                0          ;with zero
      INI          K 99          ;Increment index and modify
accu state
      JR           H LOOP ;If accu is high, program jump to label
LOOP
      EXOB
      COB          0            ;Cyclic organization block
                                0
      ...
      ECOB
```

7.5.12 Program jumps

The IL instruction set has three program jump instructions. They allow a sequence of instructions to be processed according to a binary condition binary, or program loops to be implemented for repetitive tasks (indexing).

Jump instructions		
JR	Jump relative	Jumps a few lines forward or back from the line containing the JR instruction
JPD	Jump direct	Jumps to a line number counting from the start of block (COB,PB,...)
JPI	Jump indirect	As JPD, but the line number is contained in a register

The jump destination is generally indicated by a label that defines a line of the program. However, it is also possible to define a relative jump with the number of lines to jump forward or back.

Jump using a line label :

```
JR    L Next
      INC
Next: NOP
```



Jump using the number of lines:

```
      JR    L +1
R 10  INC    R 10
      NOP
```



The jump must always occur within a current block (COB, PB,...) never outside it.

If necessary, the jump may be implemented always, or only under a predetermined binary condition, such as the accumulator state or that of a status flag.

Syntax for an unconditional jump instruction

Mnemonic	Label	Description
JR		Jump always implemented on line corresponding to label
JPD		
JPI		

Syntax for a conditional jump instruction

Mnemonic	Condition	Label	Description
JR	H		If accu is high
JPD	L		If accu is low
JPI	Z		If status flag Z is high
	P		If status flag P is high
	N		If status flag N is high
	E		If status flag E is high

Example: Count pulses from a binary input binary with a register (relative jump)

Unlike counters, the instruction to increment a register does not depend on accumulator state. It is therefore practical to use a jump instruction to increment a register when only that is necessary.

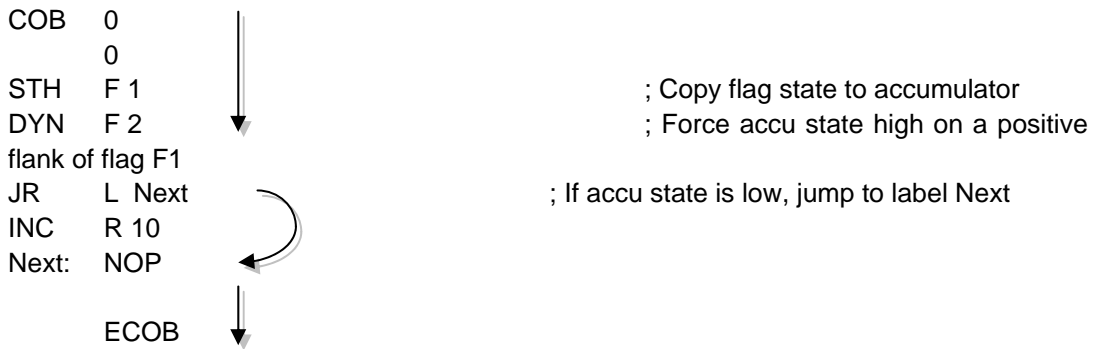

The instructions *STH* and *DYN* read information from flag F 1 and set the accu state high for a positive flank or low in the absence of a flank. Depending on accu state, the instruction *JR* either jumps to the line corresponding to the label *Next:* or increments the register with the instruction *INC*. The letter *L* indicates the condition for implementing a jump (in this example, the jump will only be implemented if the accumulator state is low).

Example: Solution with an indirect jump

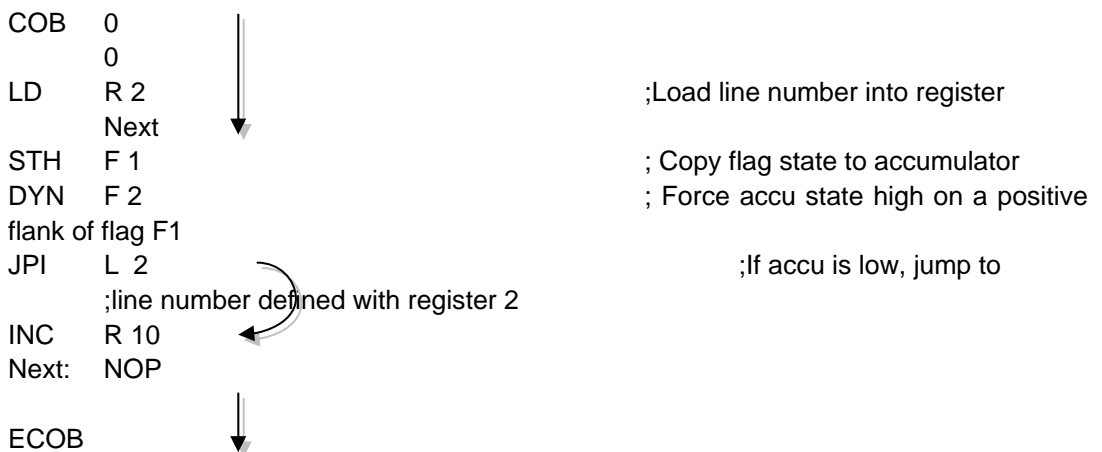

The indirect jump offers great flexibility. The program can itself modify the line number to which it will jump.

7.6 Editing a first application program

Count the number of spaces left in an 8-space parking lot and illuminate a red lamp when it is full.

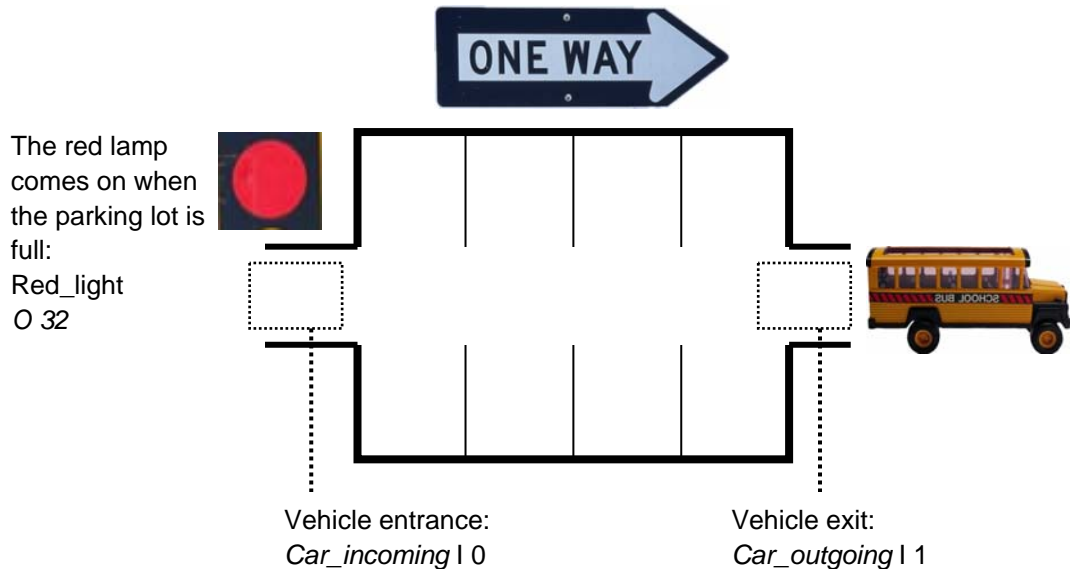

When the PCD powers up, we assume that all parking spaces are available. We must therefore start by initialising the free space counter with the value 8. This initialisation takes place once only, when the PCD starts up. We will therefore program it in the cold-start block: XOB 16. The remaining program functions will be carried out by a cyclical organisation block (COB).

At the entrance, the sensor *Car_incoming* delivers a pulse each time a new vehicle enters. The rising edge of this signal must be detected to decrement the free space counter.

At the exit, a second sensor *Car_outgoing* delivers a pulse each time a vehicle exits. The rising edge of this signal must be detected to increment the free space counter.

If the parking lot is full, the counter's integer value will indicate zero available spaces. The counter's logic state informs us of this situation when it is low. The red lamp at the entrance to the parking lot must therefore be illuminated.

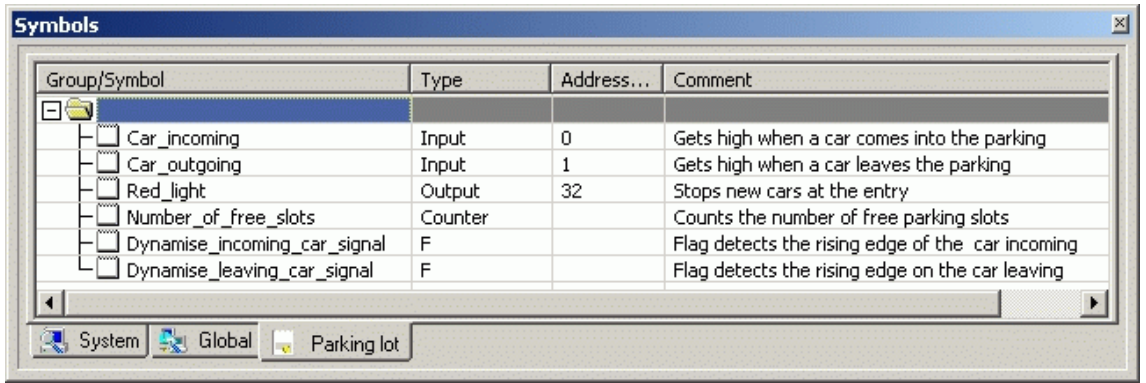

```

;-----
; Cold start organisation block
;-----

```

```

XOB 16 ; Program executed at start up
ACC H
LD Number_of_free_slots ; Initialize the free slots counter
8 ; with the value 8 (unconditionally)
EXOB ; End of start-up program

```

```

;-----
; Cyclical Organisation Block
;-----

```

```

COB 0 ; Cyclical program
0 ; No supervision time

STH Car_incoming ; A car comes into the parking:
DYN Dynamise_incoming_car_signal ; On the positive flank of incoming signal
DEC Number_of_free_slots ; Decrement the number of free parking slots

```

```

;-----

```

```

STH Car_outgoing ; A car leaves into the parking:
DYN Dynamise_leaving_car_signal ; On the positive flank of outgoing signal
INC Number_of_free_slots ; Increment the number of free parking slots

```

```

;-----

```

```

STL Number_of_free_slots ; If no more free parking slots(counter state = Low)
OUT Red_light ; Set the red light

ECOB ; End of Cyclical program

```

7.7 Building the program



Build All

The user program is fully edited, but not yet usable by the PCD. It must be translated into a binary file. This is what the programming tool does when the user activates the *CPU Build* menu, or the *Build* button in the project manager or IL editor.

The Messages window tells us how the build is proceeding. It will be noted that the build has assembly and linkage stages. If the program has been edited correctly, the build will end with the message *Build successful. Total errors 0 Total warnings: 0*

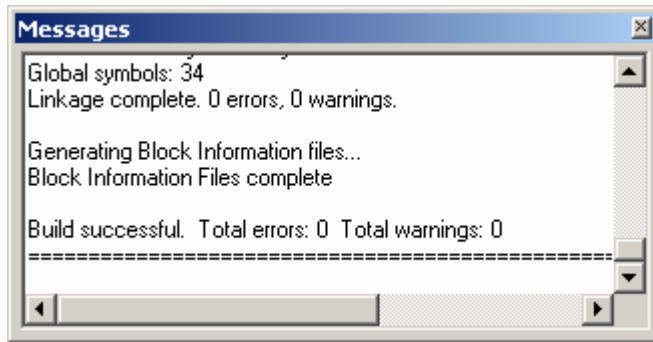

Any errors will be indicated by a message in red. A double mouse-click on these messages will allow the error to be located in the application program.

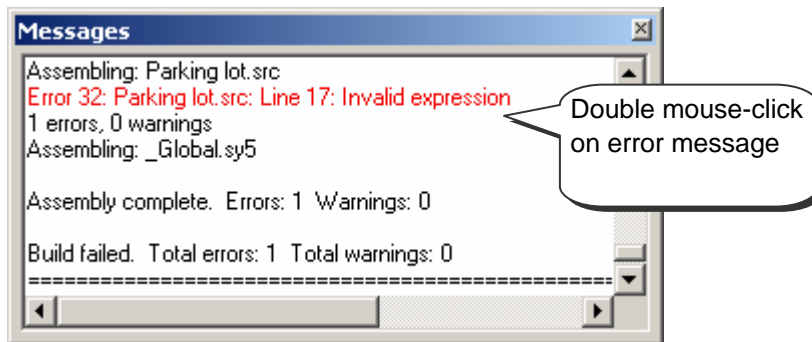

The error is marked in red

STH	Car_incomingZ
DYN	Dynamise_incoming_car_signal
DEC	Number_of_free_slots

Correction of error

STH	Car_incoming
DYN	Dynamise_incoming_car_signal
DEC	Number_of_free_slots

7.8 Load program into PCD



Download Program

The application program is ready. Now it must be transferred from the computer to the PCD either with the menu *Online, Download Program*, or with the *Download Program* toolbar button, on the SAIA Project Manager window.

If any communications problems arise, check your configurations once again in *Settings Online* and *Settings Hardware* and check your communications cable between the computer and the PCD. (PCD8.K111, USB)

7.9 Debugging a program

Programs are not always perfect in their first version. It is helpful to test them carefully. Testing a program is supported by the same editor used for editing it.

7.9.1 Viewing compiled code



Show Hide Code

The *View Code* menu, or then *Show/Hide Code* button, allow source code and code obtained after a build to be viewed on a single IL page.

The white lines represent the original source code, with symbols and comments.

The grey lines represent the code produced by the build, with the addresses of operands and program line numbers.

```

Parking lot.src
; Cyclical Organisation Block
;-----
          COB      0          ; Cyclical program
          0          ; No supervision time
000007 COB      0
000008 COB      0
000010 NOP

          STH      Car_incoming |          ; A car comes into the parking:
000011 STH      I|0 0
          DYN      Dynamise_incoming_car_signal ; On the positiv flank of incoming sig
000012 DYN      F 7502
          DEC      Number_of_free_slots      ; Decrement the number of free park:
000013 DEC      C 1400

;-----

          STH      Car_outgoing          ; A car leaves into the parking:
000014 STH      I|0 1
          DYN      Dynamise_leaving_car_signal ; On the positiv flank of outgoing sig
000015 DYN      F 7503

          INC      Number_of_free_slots      ; Increment the number of free park:
000016 INC      C 1400
    
```

7.9.2 Go On/Offline, Run and Stop

Online mode allows communication with the PCD to check the mode of operation (Run, Stop, Step-by-step). Any information needed to test the program can also be displayed.

Press *Go On /Offline* button

Put controller into run mode with *Run* button



At the same time, note the RUN lamp, located on the front of the PCD. When the *Run* button is pressed, the RUN lamp comes on. The PCD is executing the user program.

When the *Stop* button is pressed, the *RUN* lamp goes off. The PCD stops executing the user program.



After *Stop*, note the line shown in red. It indicates the instruction at which the program stopped. The number in square brackets represents the integer value of counter 1400. Then, further right, states are displayed for the accumulator, status flags and index register.

```

      DYN   Dynamise_leaving_car_signal ; On the positiv flank of outgoing signal
000015 DYN   F 7503
      INC   Number_of_free_slots       ; Increment the number of free parking slots
000016 INC   C 1400                    [8]          A0 Z0 N0 P1 E0 IX0000
  
```

7.9.3 Step-by-step mode



Run to Cursor

If the PCD is in run mode, mark the first line to observe in step-by-step mode and select the *Run to Cursor* button.

The PCD stops when it reaches the line with the cursor. Begin step-by-step program execution by pressing the F11 key, or one of the buttons below.

If the program calls any PBs, FBs or SBs, it is not always necessary to step through them in with step-by-step mode. The following three options are available:



- Enter the block and step through it



- Process the called block in run, then continue in step-by-step after returning to the block that made the call.



- If the program has entered a block whose content is of no interest, it is possible to exit it rapidly in run mode and then continue in step-by-step mode after returning to the block that made the call.

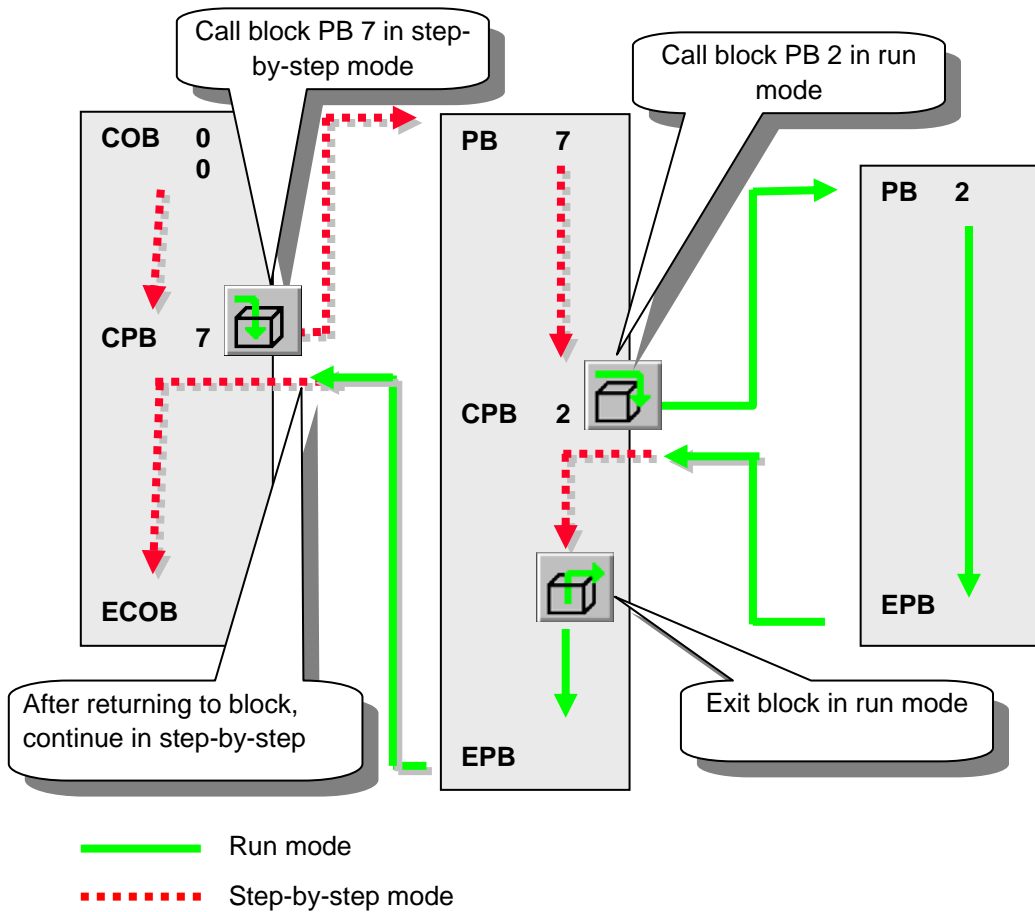

```

STH Car_outgoing ; A car leaves into the parking:
000014 STH I|0 1 [0] A0 Z0 N0 P1 E0 IX0000
    
```

For each program step, note the line shown in red. It moves to the following instruction line. The figure in square brackets represents the logical state of input I 1. Further to the right, the states of the accumulator, status flags and index register are displayed.

7.9.4 Breakpoints

Breakpoints let you stop the program at an event linked to a program line or a symbol:

- State of an input, output, flag, status flag
- Value present in a register or counter

Breakpoint on a symbol



Set/Clear
Breakpoint

The breakpoint condition can be defined with the help of the *Online Breakpoints* menu, or of the *Set/Clear Breakpoint* button.

Type:	Address:	Condition:	Value:
Counter	1400	>	4
Output	32	=	0

Using the above window, define the symbol type and address/number, or just drag a symbol from the symbol editor into the *Symbol Name* field, then set the breakpoint condition and state/value.

Selecting the *Set&Run* button forces the PCD into *conditional run* mode. The PCD's *Run* LED flashes and the PCD's *Run* button alternates between green and red.

The PCD automatically goes into stop mode when the breakpoint condition is reached. For example, when an instruction modifies the value of counter 1400 with a value greater than 4. The line following the last instruction processed by the PCD will be marked in red. It is then possible to continue processing the program in step-by-step mode, or with another breakpoint condition.

If necessary, conditional run mode can be interrupted in the following ways:

- The *Clear-Run* button forces the PCD into RUN mode. The PCD's *Run* LED comes on and the PCD's *Run* button turns green.
- The *Clear-Stop* button forces the PCD into stop mode. The PCD's *Run* LED goes off and the PCD's *Run* button turns red.

If more than one conditional breakpoint has been set, they are all stored in the *History* field. They can be selected with the mouse and activated with the *Set&Run* button.

Breakpoint on a program line

By selecting a program line, followed by the menu *Online, Run To, Cursor*, the program can be made to stop at the line chosen and then continue in step-by-step mode.

7.9.5 Online modification of the program

When testing a program step-by-step, it is helpful to modify the states/values of certain operands/symbols and check program behaviour under certain conditions.

Select one of the active lines (grey) using the mouse and right-click to display the context menu.

The *Edit Data* context menu allows you to modify the operand state/value in the instruction selected.

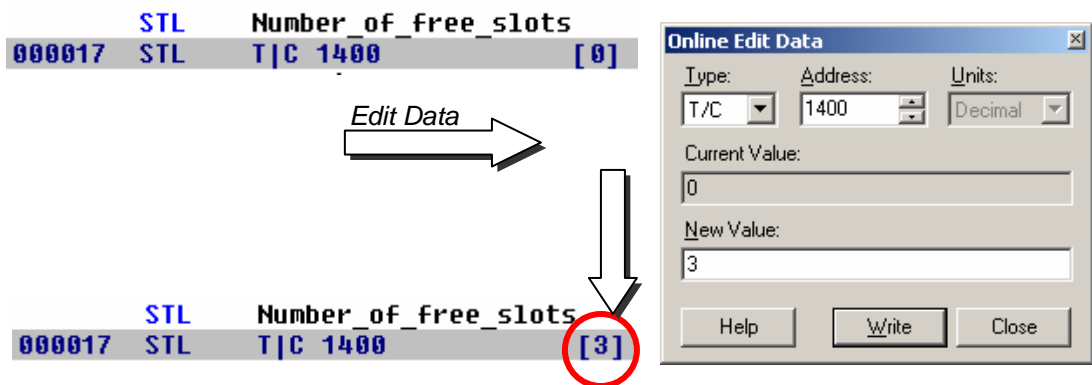

The *Edit Instruction* context menu allows you to modify the mnemonic and address of the operand corresponding to the selected instruction line.

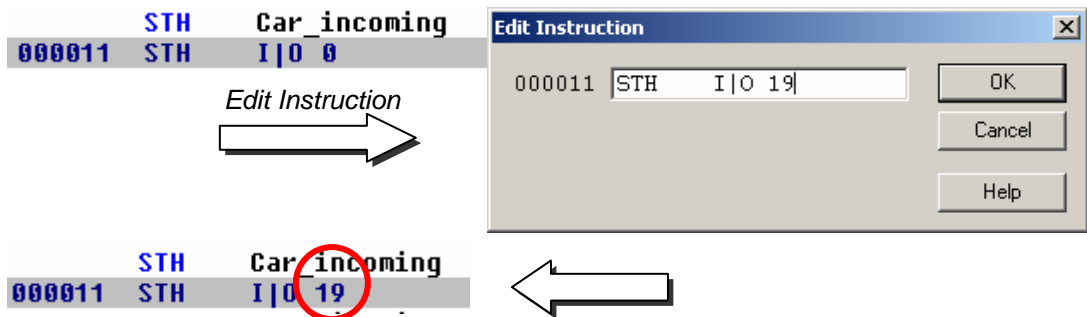

Status flags can also be modified with the help of the *Edit Status* context menu.

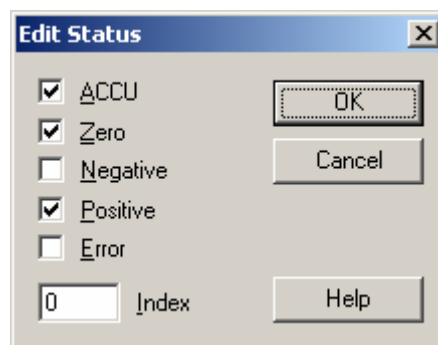

7.9.6 Viewing and modifying symbol states with the *Watch Window*

Another useful way of testing and viewing the state of symbols in our example is provided by the *Watch Window*. Press the *Watch Window* button. Then drag symbols from the symbol editor into the *Watch Window*

1. Position mouse cursor in centre of symbol icon and press left-hand button

2. Keep mouse button down and drag symbol into *Watch Window*

3. Symbols with their comments and states/values

4. *Start/Stop Monitoring*

Symbol	Address	Value	Modify Value	Symbol Comment
Car_incoming	I 0	0		Gets high when a car comes i...
Car_outgoing	I 1	0		Gets high when a car leaves t...
Red_light	O 32	0		Stops new cars at the entry
Number_of_free_slots	C 1400	8		Counts the number of free p...

To modify the state/value of one of the symbols in the window, proceed as follows:

1. *Start/Stop Monitoring*

2. Position mouse pointer on value to be edited. Double left-click with mouse and edit new value.

3. *Download Values*

Symbol	Address	Value	Modify Value	Symbol Comment
Car_incoming	I 0	0		Gets high when a car comes i...
Car_outgoing	I 1	0		Gets high when a car leaves t...
Red_light	O 32	0		Stops new cars at the entry
Number_of_free_slots	C 1400	8	5	Counts the number of free p...

7.10 Commissioning an analogue module

All program instructions presented up until now have made use of digital inputs or outputs, putting their addresses or symbols in front of the mnemonic.

Example : ANH I 45

With analogue inputs or outputs, however, an acquisition routine must be used for the analogue value. There are different routines for the different types of analogue module. Descriptions will be found in the hardware manual of your PCD.

7.10.1 Example for PCD2.W340 analogue input modules

If the PCD is equipped with a PCD2.W340 module, which has 8 universal input channels, the following routine may be used:

```

BA    EQU          O 96    ; Module base address in PCD
      ACC          H       ; ACCU must be high
      LD           R 100   ; Defines the measuring channel ( 0...7)
                          2

      MUL          R 100
                          K 32    ; Calculates
                          R 100   ; control byte
      ADD          R 100   ; including
                          K 264   ; release bit.
                          R 100

      SET          BA+15   ; Triggers A/D conversion

      BITO         9       ; Sends control byte
                          R 100   ; including release bit
                          BA+0    ; to W3xx

      BITIR 12     ; Reads the 12 bits of the measurement (0...4095) into R 77
                          BA+0
                          R 77

      RES          BA+15   ; Stop A/D conversion

```

The PCD2.W340 is a universal module. It supports measurement of ranges 0..10V, 0..2.5V, 0..20 mA and Pt/Ni 1000 temperature sensors. A bridge must be selected on the module to define the measurement range. Resolution is 12 bits, equating to 4095 distinct measured states.

The routine shown above enters the channel defined in register 100 and supplies a raw measurement to register 77. For this module with a resolution of 12 bits, that corresponds to a measured value between 0 and 4095.

The user then has the task of converting the measurement into a standard physical unit.

7.10.2 Example for PCD2.W610 analogue output modules

Outputs work in a similar way to inputs.

If the PCD is equipped with a PCD2.W610 module, which has 4 universal analogue output channels, the following routine may be used:

```

BA    EQU O 96      ; Module base address in PCD
      ACC H        ; ACCU must be high
      LD  R 100     ; Defines output channel ( 0...6)
              2
      BITOR          2          ; Transfers channel to W6x0
              R 100
              BA+0
      BITOR          2          ; Writes 2 filler bits
              R 100
              BA+0
      LD  R 277     ; Defines the digital value of the output ( 0...4095)
              3879
      BITO R 12     ; Transfers the 12 bits of the output value to the W6x0
              R 277
              BA+0
      SET BA+12    ; Triggers D/A conversion
  
```

A bridge must be selected on the module to define the output range: 0...20 mA or 0...10 V. Resolution is 12 bits, equating to 4095 distinct setpoint states.

The integer value at register 12 determines the output voltage or current at the channel defined in register 100:

Input value at register 12	Output voltage [V]	Output current [mA]
0	0	0
2047	5	10
4095	10	20



To obtain more detailed information and access sample IL programs for analogue modules, please refer to your hardware manual or to internet address:

<http://www.sbc-support.ch>

Contents

8	ADDITIONAL TOOLS	3
8.1	Introduction	3
8.2	Data transfer utility	4
8.2.1	Using data transfer	4
8.2.2	Start up <i>Data Transfer</i>	4
8.2.3	Save data with Quick Data Upload	4
8.2.4	Restore data	5
8.2.5	Save data with help of script file	5
8.2.6	Restore data with help of script file	6
8.2.7	Upload options	6
8.2.8	Save data with command line mode	7
8.3	Watch window	8
8.3.1	Open the <i>Watch Window</i>	8
8.3.2	Add data to a <i>Watch Window</i>	9
8.3.3	Online display of data	10
8.3.4	Online modification of data	10
8.3.5	Display format	10
8.3.6	<i>Watch Window</i> and applications with several CPUs	11
8.4	Online configurator	12
8.4.1	Offline configurator	12
8.4.2	Online configurator	12
8.4.3	Online Configurator window	12
8.4.4	Adjust the PCD's clock	13
8.4.5	PCD History	13
8.5	EPROM programming	14
8.6	Updating firmware. (<i>Firmware Downloader</i>)	15
8.7	User menus	16

8 Additional tools

8.1 Introduction

The PG5 provides you with several additional utilities for a variety of services.

8.2 Data transfer utility

8.2.1 Using data transfer

This tool is used to save PCD data states/values in an ASCII file (*.dt5) or to restore them from the file into PCD memory.

The following data is transferred with this tool:
inputs, outputs , flags, timers, counters, registers, data and text blocks.

Caution! The PCD program and hardware configurations are not saved by the *Data Transfer* utility. To save the program, hardware configurations and data, it is advisable to back up the program. See description of Project Manager.

8.2.2 Start up *Data Transfer*

Start up the program with menu:
Start --> Programs --> SAIA PG5 V 1.4 --> Data Transfer

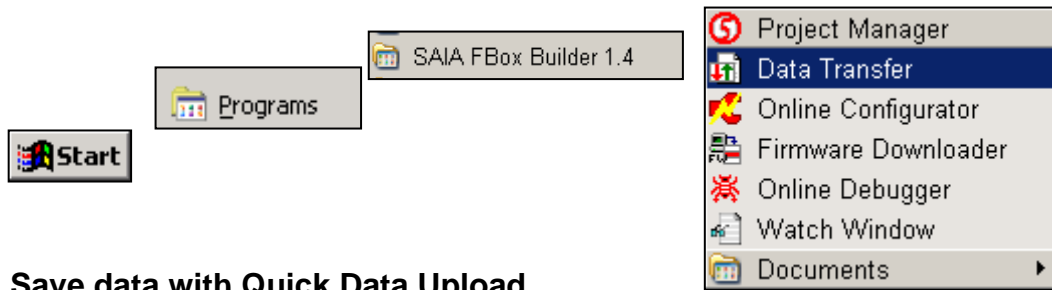

8.2.3 Save data with Quick Data Upload

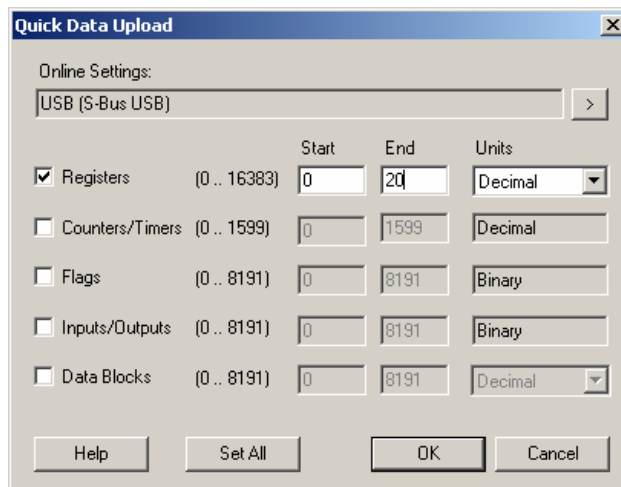

Select menu *Online, Quick Data Upload ...* or press the *Quick Data Upload* button to display the above window.

Select the types of data to save, address ranges, possibly also the display format for registers.

Select the OK button to upload data.

If a message like the one shown here is displayed, check the communications parameters using the *Online, Settings Online* menu and ensure that the PCD8.K111 cable correctly links the PC to the PCD.

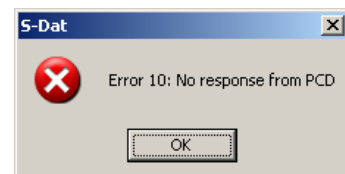

Data upload takes a few moments to be displayed as follows:

```

;PCD DATA TRANSFER: S-Dat B1.4.040
;Uploaded: 10/01/06 16:58:43, From:

R 0      0 0 0 0 0
R 5      0 0 0 0 0
R 10     0 0 0 0 0
R 15     0 0 0 0 0
R 20     0
    
```

The data file can be edited with new values, then saved with the *File, Save* menu, or with the *Save* toolbar button.

8.2.4 Restore data



Open

Previously saved files can be displayed again with the *File, Open* menu, or the *Open* toolbar button.

If necessary, the user can edit file values.



Download
To PCD

Data is restored to PCD memory with the *Online, Download Data to the PCD* menu, or with the *Download* button.

8.2.5 Save data with help of script file

If necessary, the list of data to save can be edited in a script file. Example:

```

;Exemple de script

R 0-99,          ;Sauvegarde les registre 0 à 99 avec un format décimal
R 12, %h         ;Sauvegarde le registre 12 avec un format hexadécimal
R 55, %f         ;Sauvegarde le registre 55 avec un format flottant
F 0-999,         ;Sauvegarde les indicateurs 0 à 999
F 1000,          ;Sauvegarde l'indicateur 1000
    
```



Upload
From PCD

Select the *Online, Upload Data from PCD ...* menu, or the *Upload* button, to upload PCD data into a second window, distinct from the control window.

For more information about script commands available, please refer to program help. See menu *Help, Help Topics F1, General*.

8.2.6 Restore data with help of script file

A script file also allows you to edit data to be restored. Example:



```

;Exemple de script
R 0-99, 0 ;Charge les registre 0 à 99 avec zéro
R 12, 32h ;Charge le registre 12 avec 32 hexadécimal
R 55, 64.3 ;Charge le registre 55 avec 64.3 flottant
F 0-999, 0 ;Charge les indicateurs 0 à l'état bas
F 1000, 1 ;Charge l'indicateur 1000 à l'état haut

```

Select the *Online, Download Data to PC* ... menu or the *Download* button to download script data to the PC.

8.2.7 Upload options

The window displayed with the *Edit, Options* menu allows you to adjust the format of data to be saved in file '*.dt5'.

With the following options, a data file can easily be imported to a *Microsoft Excel* editor.

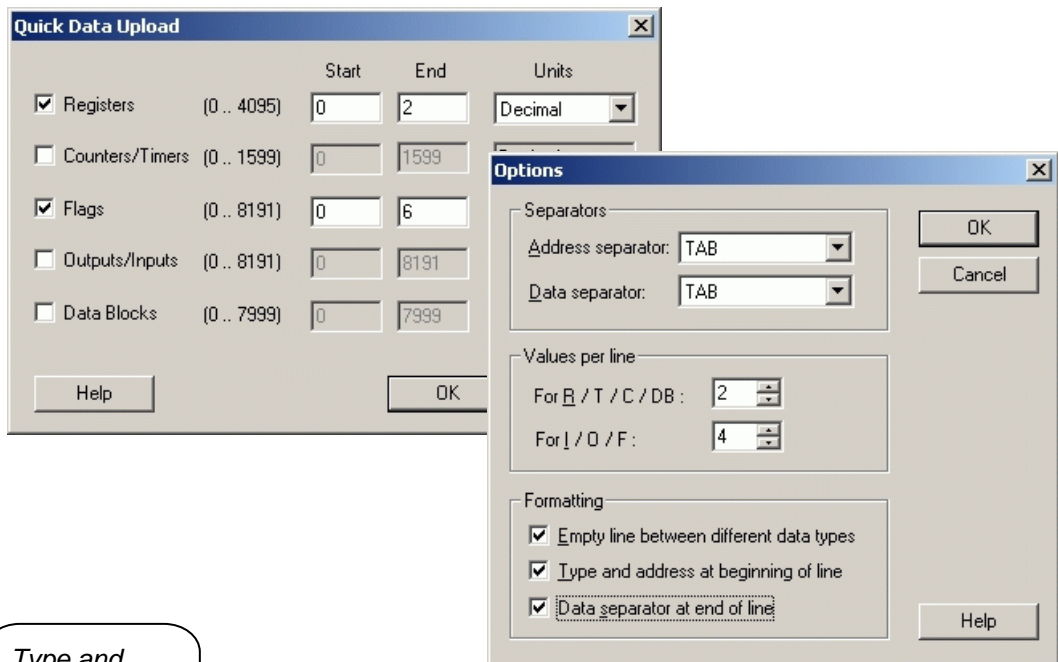

8.2.8 Save data with command line mode

The *Data Transfer* tool can also be controlled with the help of DOS command lines. This allows batch files to be created for the regular, automatic saving of PCD data. The data can then be used by a Microsoft Excel program or database, ...

Command line syntax:

SDAT [Name_of_file[.dt5]][data...]][/R=nnn]/I0nnn]/[A=nnn]/[D=nnn]

Name_of_file	Name of file to save/restore
Data...	Definition of data to save. If no data is defined, the file is restored to the PCD
	<i>Format : <type><start>[-<end>][[units]</i>
type	R,C,O,F,DB (C= counters/timers, O = inputs/outputs) First address
start	Last address
end	D,H,F (Decimal, hexadecimal, floating point) for R,C,DB
units	
/R=nnn	nnn = value per line for R,T,C,DB (1..256, default = 5)
/I =nnn	nnn = value per line for I,O,F (1..256, default = 10)
/A=nnn	nnn = address separator (TAB,SPACE,COMMA,COLON , default= TAB)
/D=nnn	nnn = data separator (TAB,SPACE,COMMA,COLON , default= TAB)

Example:

sdat5 MyDatas.dt5 R0-99 R12H R55F F0-999 F1000 /R005 /I010

8.3 Watch window

The *Watch Window* is an excellent tool for checking programs and installations. It allows all the data of an application to be viewed and modified online.

8.3.1 Open the *Watch Window*



Watch
Window

The *Watch Window* is displayed by selecting the *View, Watch Window* menu, or with the *Watch Window* button.

It is also possible to prepare several different *Watch Windows* in the *Program File* directory of the project manager. Add a new *Watch Window File (*.5ww)* with the *File New* menu, or with the *New File* button.

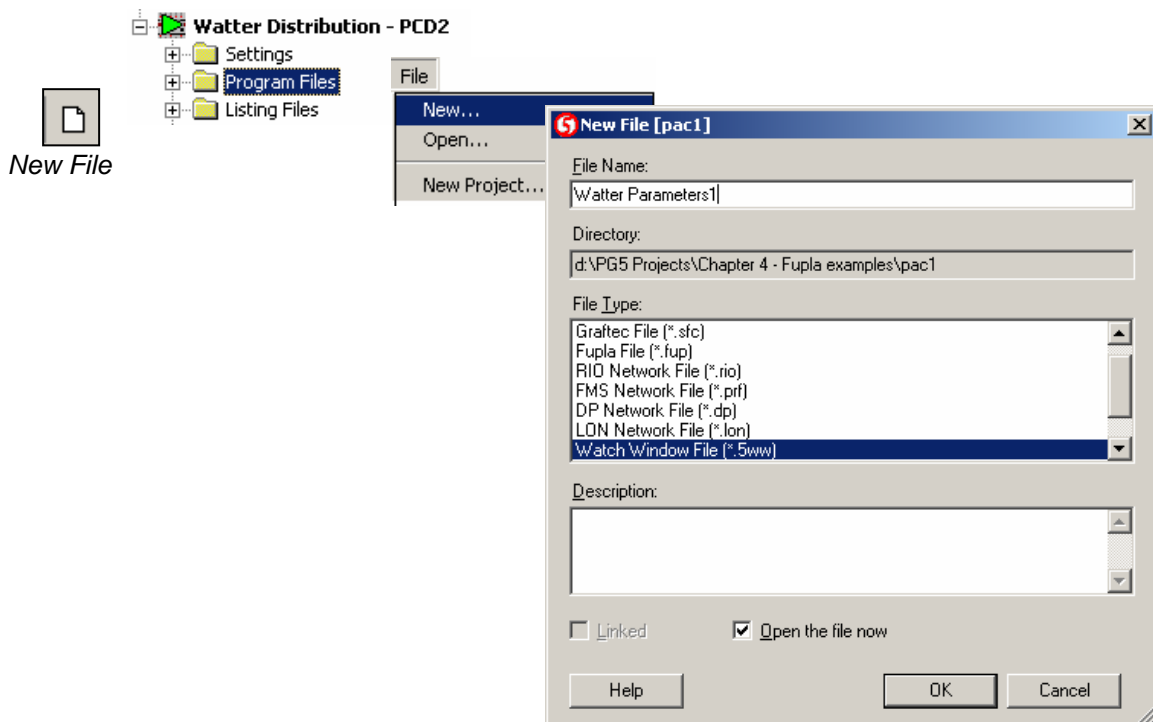

N.B.: Files of the type *.5ww are never linked to a project (no arrow inside the file icon). The information in them has no bearing on any program build.

To open a *.5ww file, select it with a double mouse-click, or mark the file and select the *File Open* menu.

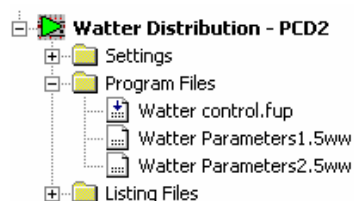

8.3.2 Add data to a Watch Window

Drag symbols from the program or from the symbol editor into the Watch Window.

Watch Window

1. Position mouse cursor in centre of symbol icon. Press left mouse button.

2. Hold down mouse button and drag symbol into Watch Window.

3. Symbols with their comments and states/values

4. Start/Stop Monitoring

Symbol	Address	Value	Modify Value	Symbol Comment
HMS	R 2113	103034		PCD Clock with current time
DailyTimer	O 32	1		Daily Timer
Ontime	R 2115	60000		Switch on time
OFFTIME	R 2114	19000		Switch off time

It is also possible to edit symbols directly in the window:

Edit new address

Symbol	Address	Value	Modify Value	Symbol Comment
DailyTimer	O 32	1		Daily Timer
ONTIME	R 2005	60000		Switch on time
OFFTIME	R 2004	19000		Switch off time

8.3.3 Online display of data



Start/Stop Monitoring

The *Start/Stop Monitoring* button lets you display values present in the PCD for each of the symbols in the Watch Window.

Check that the Watch Window's status bar indicates *RUN* mode. If necessary, force the PCD into *RUN* or *STOP* with the *Online* menu.

8.3.4 Online modification of data

The *Modify Value* column lets you define new values for a number of symbols and download them into the PCD by selecting the *Download Values* button.

Symbol	Address	Value	Modify Value
HMS	R 2003	102433	
DailyTimer	O 32	1	
ONTIME	R 2005	60000	83000
OFFTIME	R 2004	19000	180000

Symbol	Address	Value
HMS	R 2003	102816
DailyTimer	O 32	1
ONTIME	R 2005	83000
OFFTIME	R 2004	180000

8.3.5 Display format

The display format of values can be adjusted as required.

Example: Display register R 2004 in hexadecimal

Address	Value
O 32	0
R 2003	113245
R 2004	182000
R 2005	53000

Cut	Ctrl+X
Copy	Ctrl+C
Paste	Ctrl+V
Insert Line	Ins
Delete Line	Del
Move Up	Ctrl+Up
Move Down	Ctrl+Down
Units	▶
Show	▶

Decimal	Ctrl+D
Floating Point	Ctrl+F
• Hex	Ctrl+H
Binary	
ASCII	

Address	Value
O 32	0
R 2003	113245
R 2004	0002C6F0H
R 2005	53000

8.3.6 Watch Window and applications with several CPUs

The Watch Window lets you open several documents at one time. The menu, toolbar and status bar always relate to the active window, i.e. the window identified by a blue header bar.

By default, each open Watch Window document uses the *Online settings* of the CPU to which it belongs. Data from different PCDs available in the project can therefore be displayed on the communications network..

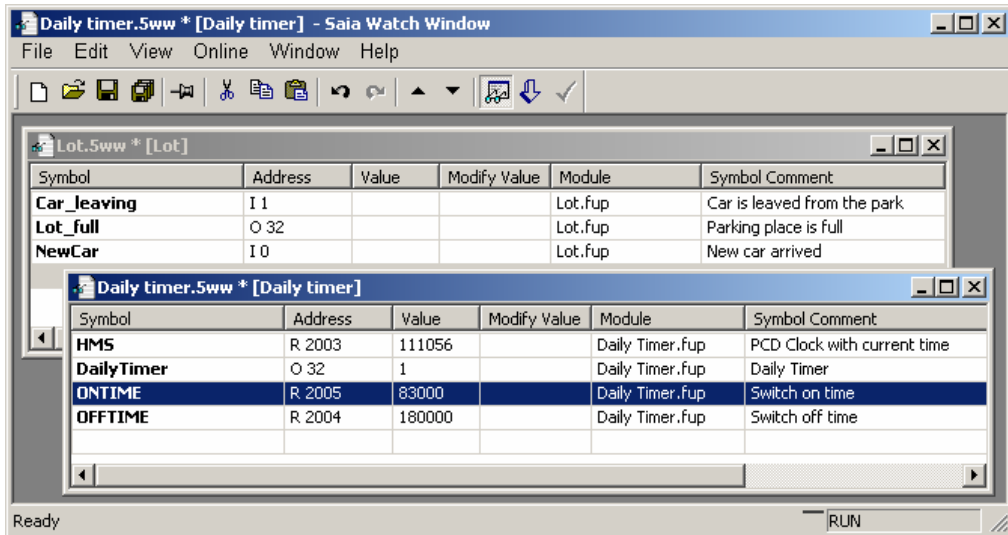

8.4 Online configurator

The PG5 provides two configuration tools:

The offline configurator, which can be accessed from the *Hardware Settings* of the Project Manager.

The online configurator, which can be accessed with the Tools menu, *Online Configurator*, or with the *Online Configurator* button.

8.4.1 Offline configurator

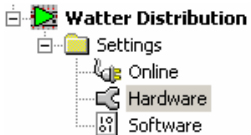

Configures memory, communications parameters and the PCD password. This information is saved in a PG5 project file. The user must use the *Download* button to force a download of the configuration into PCD memory.

8.4.2 Online configurator



Configures memory, communications parameters and the PCD password. However, this information is written directly to PCD memory. No copy of the information will remain in the PG5 project.

Without a controller, nothing can be known about this information.

It is therefore preferable to use the online configurator for checking PCD data and to configure them with *Hardware Settings*.

8.4.3 Online Configurator window

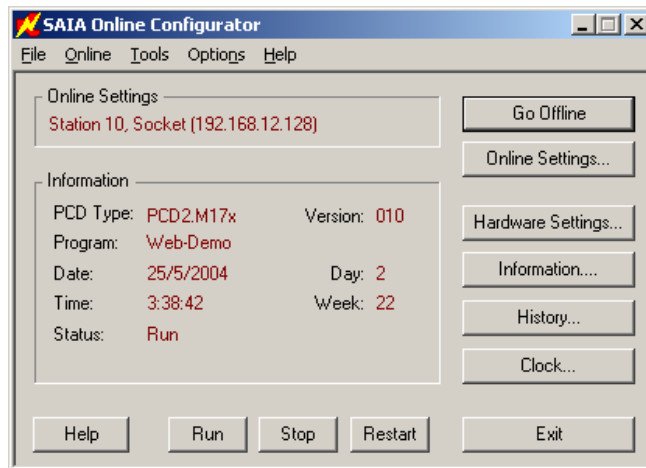

<i>PCD type</i>	PCD type reference number
<i>Version</i>	Version of PCD firmware
<i>Program Name</i>	User program name
<i>Date</i>	PCD clock date (if no clock: 1/1/92)
<i>Time</i>	PCD clock time
<i>Day</i>	Day of week: 1 = Monday, ... 7 = Sunday
<i>Week</i>	Week number
<i>Status</i>	Mode of operation: Run, Stop, Halt, Conditional
<i>Run</i>	
<i>Online settings</i>	Connection direct PGU or S-BUS

If the information in red is not displayed, or if a *No response* message box is displayed, it is not possible to establish communications between the PCD and the *Online Configurator*.

If so, please check:

Is the computer correctly connected to the PCD with PCD8.K111/USB cable?

Have communications parameters been selected correctly with the *Settings* button?

Hardware Settings...

Configuration of PCD memory. These are the same parameters as those already given with the *Hardware Settings* of the Project Manager.

8.4.4 Adjust the PCD's clock

Clock...

1. Select the *Online configurator* button in the *SAIA Project Manager* window. Then select *Clock* button.
2. Copy time from the PC to the controller with the *Copy to PCD >>>* button, or adjust the clock in the *SAIA PCD Clock* fields.

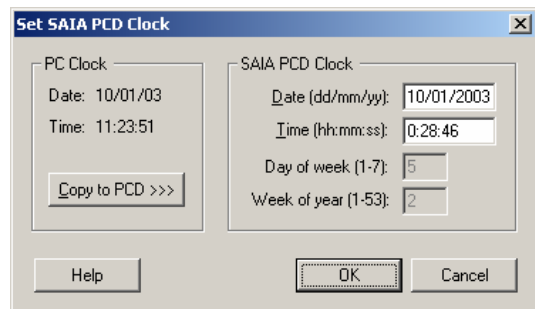

8.4.5 PCD History

Hjstory...

The *History* logs all hardware or software errors that occur during PCD operation. This table is permanently updated, even if the XOBs have not been programmed. Consult the history when the CPU's *Error* lamp comes on.

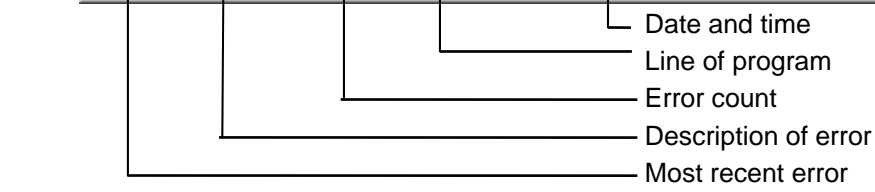
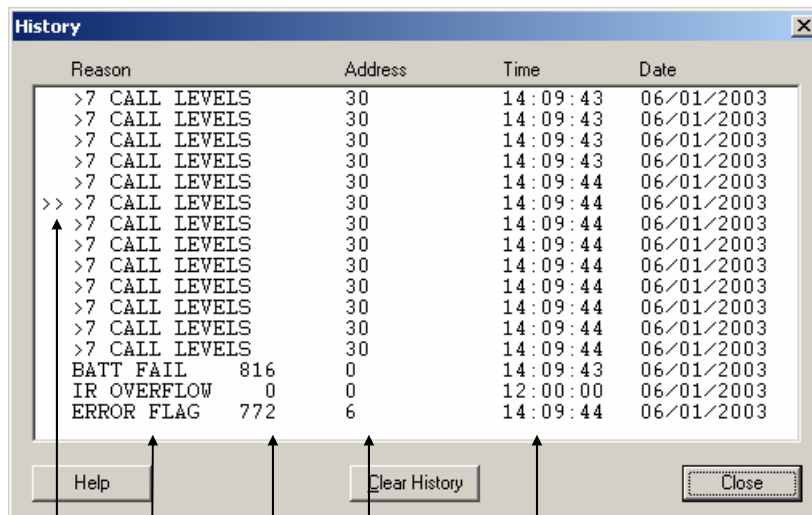

Notes:
 Each CPU has its own history.
 The *BATT FAIL* error only exists on CPU 0.

If an error can be traced to a line of the program, it will be specified. Otherwise it is displayed in hexadecimal.

XOB 0 only appears if it has been programmed.

8.5 EPROM programming

PG5 supports the creation of binary or hexadecimal files for all types of standard EPROM programmers on the market.

From Project Manager, select menu *CPU, Create Hex Files ...*

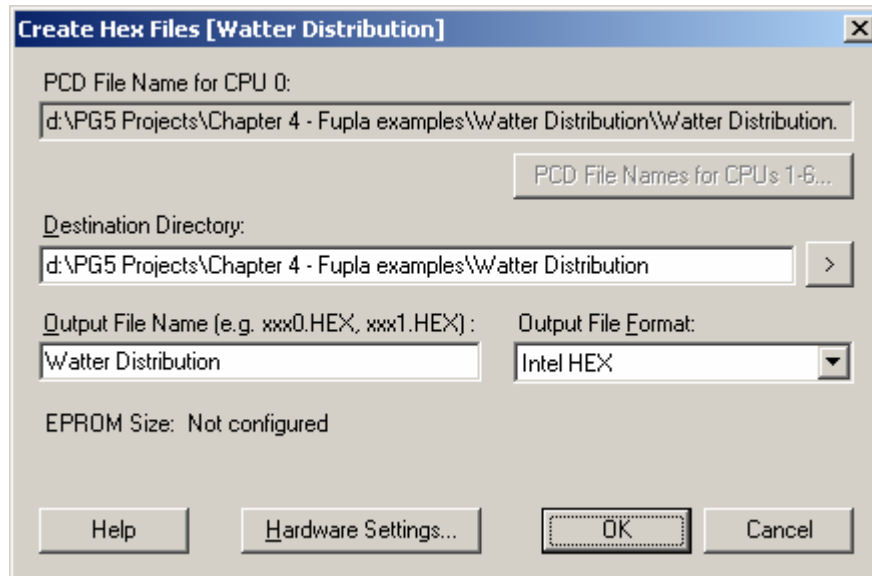

To create an EPROM file:

Configure the Hardware Settings

Build the program

Select the Output File Format

Define Destination Directory and Output File Name

Press *OK* button

Technical details

The EPROM contains not only the PCD program, but also the *Hardware Settings*. During power-up, *Hardware Settings* will be automatically copied from the EPROM to the PCD, but only if the PCD has lost that information (due to power failure from a faulty or absent battery).

When mounting the EPROM, remember to position the PCD's memory jumpers correctly.

8.6 Updating firmware. (*Firmware Downloader*)

Sometimes the program firmware has to be updated to benefit from the latest PCD product innovations.

For most controllers, firmware can be updated by changing the EPROM.

Only the most recent¹⁾ PCD firmware can be reloaded in flash memory using a little utility accessed with the *Tool, Firmware Downloader* menu of the Project Manager.

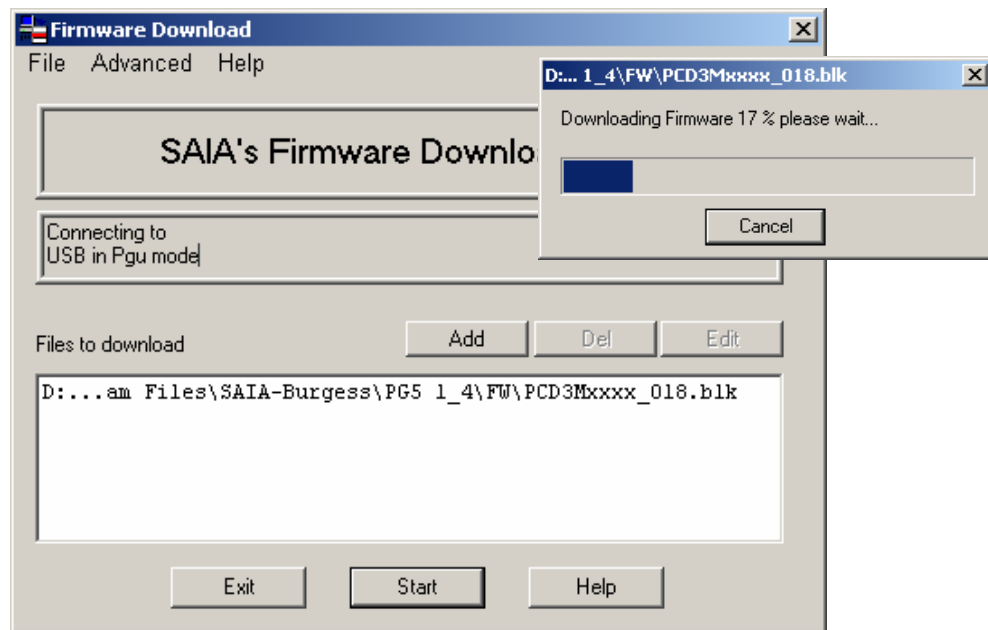

Download instructions:

The *ADD* button adds a new firmware file (*.blk) to the list: *Files*.

The most recent firmware files are available in directory *FW* on the PG5 distribution CD.

Use menu *File, Settings* to adjust communications parameters to PGU mode (only mode currently supported).

Select firmware to download into PCD.

Connect PCD8.K111 cable to PCD's PGU port.

Power off the PCD, then power on again.

With PCD2.M480, press the *Run/Halt* button twice while the *Run* LED is still flashing.

Download the firmware with the *Start* button. A dialogue box indicates the progress of data transfer.

When data transfer is complete, the PCD's *Run*, *Halt* and *Error* LEDs will start to flash. The PCD is reorganizing information in its memory. Please wait a further minute before powering off the controller, or continuing your work.

¹⁾ PCD2.M170, PCD4.M170, PCD2.M480

8.7 User menus

The *Tools* menu of the *SAIA Project Manager* window can be extended with shortcuts to your favourite programs.

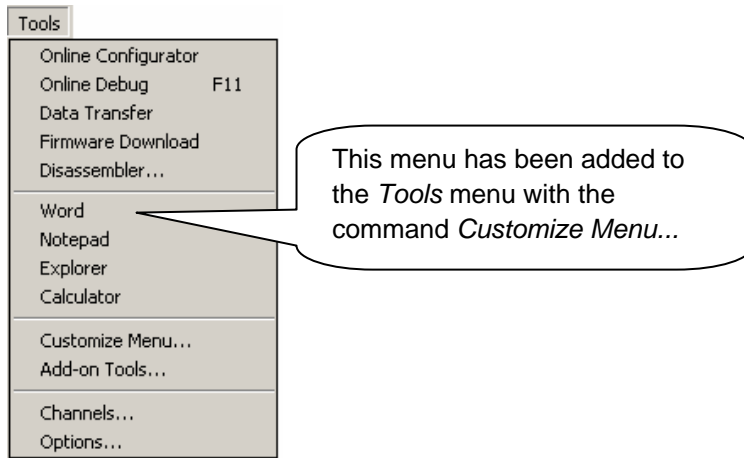

To add a shortcut, use the *Tools, Customize Menu* command. Press *Help* for more details.

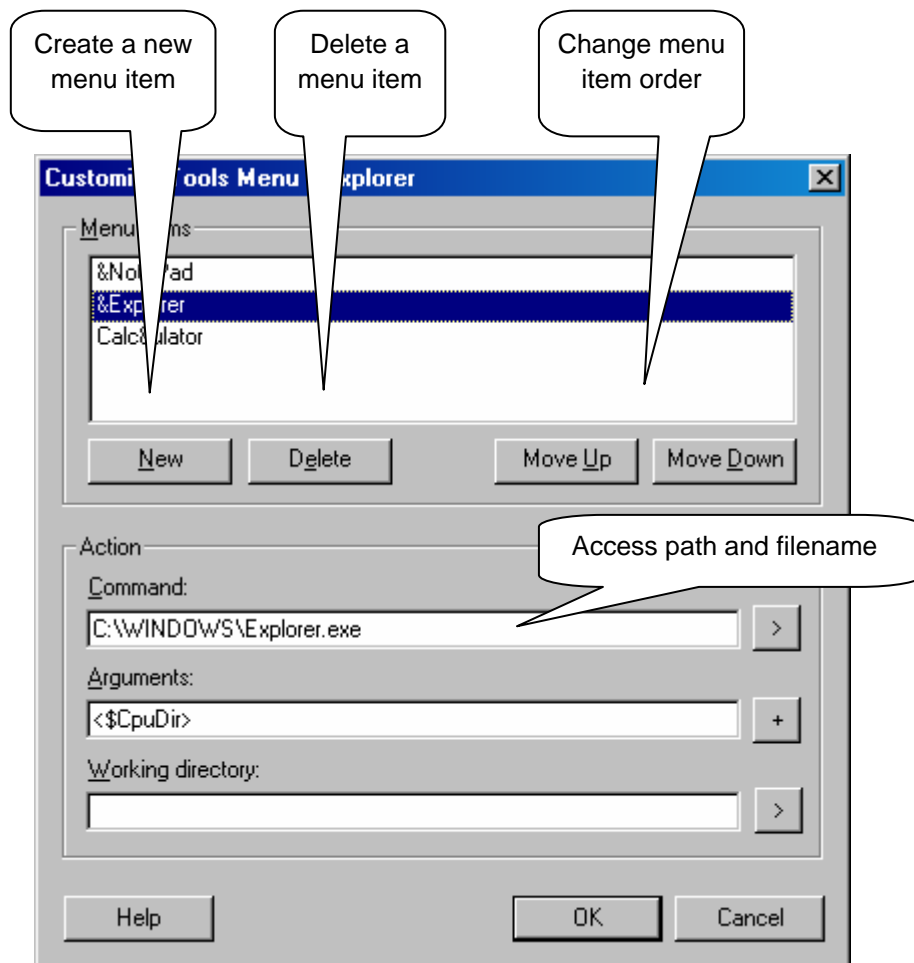

Contents

CONTENTS	1
9 SAIA NETWORKS (S-NET)	2
9.1 Summary	2
9.2 Choice of network	2
9.2.1 Supported services	2
9.2.2 Design features	3

9 Saia Networks (S-Net)

9.1 Summary

Automation solutions often consist of several decentralized PCD controllers, terminals and supervision computers, connected by a communications network. Each station controls part of the process, and exchanges data with the other stations on the network.

To guarantee the flexibility of such a concept, the PCD system supports several types of communications network. Each network has its own capabilities, so the user should choose the network which is most appropriate for the application.

The PG5 is an effective tool for implementing these solutions:

- *Saia Project Manager* provides an overview of the stations (PCDs) and their configuration parameters including the network's communications parameters.
- The Fupla or IL editor allows the programming of the data exchange between PCD stations on the network.

The programming examples described in the following chapters are all installed with the PG5, and serve as basis to test and understand the functionality of the data exchange across different PCD networks. You will notice that some examples are very close to full practical implementations.

9.2 Choice of network

The choice of network depends on the application's requirements. These are the available S-Net network types:

- Profi-S-Bus : fieldbus network based at the Profibus FDL standard
- Ether-S-Bus : information network based on the standard Ethernet
- Serial S-Bus : network based on serial interface RS 485/232
- S-Bus Modem : network based on analogue or digital telephone line
- Profi-S-IO : fieldbus network based on the standard Profibus DP
- Profibus DP: fieldbus network based on the standard Profibus DP

The different networks are distinguished by their services, technical characteristics and their application domains.

9.2.1 Supported services

Although all the communication networks support the transport of PCD data as inputs, outputs, flags, registers etc., some also support the programming, control and commissioning of the PCD systems through the network using the PG5 tools.

9.2.2 Design features

9.2.2.1 Communications speed

The communications speed defines the reaction time for the transfer of data between the stations. If the amount of data to be transferred is large, or if the reaction time must be short, then the communication speed must be high. Note that if the communication speed of the network is adjustable, the same speed must be used by all stations on the network.

9.2.2.2 Maximum distance

The distance between stations can be a limitation for stations which are a long way apart. The maximum distance cannot be exceeded without amplification of the electrical signals, using a repeater or switch / Hub. Generally the maximum distance also depends on the communications speed. The higher the speed, the shorter the distance. Reducing the communications speed can often be a solution for crossing greater distances.

9.2.2.3 Communications protocol

The "protocol" is the message format used for data exchange between stations on the network. We can compare the protocol to the language used when two people speak to each other - they will only understand each other if they speak the same language. Likewise, two stations can only exchange data if they use the same protocol.

The protocols of some communications networks are official standards. This is a great advantage when equipment from different manufacturers must communicate. Field busses and sensors often use the standard Profibus DP protocol.

On certain communication networks like Ethernet or Profibus FDL it is possible to support data exchange using different protocols on the same physical network. But in all cases, the two communicating stations must use the same protocol.

9.2.2.4 Data exchange master-slave or multi-master mode

A "master-slave" network is composed of one master station and several slave stations. The master station controls the exchange of data between the slave stations.

A "multi-master" network is composed of several master stations, and several slave stations. Each master station can exchange data with other master or slave stations.

In both cases, direct data exchange between slave stations is not allowed.

9.2.2.5 Application domains

Some networks are designed for specific uses. For example, Profibus DP is a protocol oriented towards the machinery domain. The protocol of this network is well standardized, and a lot of compatible equipment from many suppliers allows data transfer on the same bus as used for the motor commands etc.

The Ether-S-Bus network is more oriented towards supervision systems, OPC servers, or can simply be used by the PG5 programming and commissioning tools.

Serial S-Bus provides an easy way to connect PCD systems. It is a very economical network, supporting the same services as Ether-S-Bus via RS-485, but also through analogue and ISDN telephone lines (S-Bus Modem).

Communication network S-Net

Services :	Ether-S-Bus	Profi-S-Bus	Serial S-Bus	S-Bus Modem	Profi-S-IO Profibus DP
PCD Programming	Yes	Yes	Yes	Yes	No
Data Exchange	Yes	Yes	Yes	Yes	Yes
Characteristics :					
Max. transmission speed	10 and 100 Mbd	12 Mbd	38.4 /115.2 Kbd	38.4 /115.2 Kbd	12 Mbd
Max. distance without repeater or switch/Hub	100 m	100 m	1200 m	-	100 m
Cable type	4 twisted pairs	1 twisted pair	1 twisted pair	-	1 twisted pair
Protocol	Saia	Saia	Saia	Saia	Normalized ISO
Exchange mode	Multi-Master	Multi-Master	Master-Slave	Multi-Master	Master-Slave
Max. number of stations	Unlimited	126	254	Unlimited	126
Application Domain	Industry, building	Industry, building	Industry, building	Industry, building	Industry, building

The new Profi-S-Bus network merges all the advantages of a multi-master network and a high communications speed into a fieldbus network intended for industrial automation applications.

Contents

CONTENTS	1
10 PROFI-S-BUS	2
10.1 Profi-S-Bus network Example	2
10.2 Examples of the Data Exchange in Profi-S-Bus	2
10.3 The PG5 Project	3
10.4 Hardware Settings master, slaves	3
10.4.1 Define PCD parameters	3
10.4.2 Define S-Bus station number in the Network	4
10.4.3 Define communication channel of the Profi-S-Bus	4
10.4.4 Download Hardware Settings in the CPU	5
10.5 Fupla Program	5
10.5.1 Assign the channel using SASI Fbox	5
10.5.2 Assign Master channel	6
10.5.3 Assign slave channel	6
10.5.4 Principles of data exchange in a multi-master network	6
10.5.5 Data Exchange between master and slave stations	7
10.5.6 Diagnostics	8
10.6 IL programm	11
10.6.1 Assign master Channel using SASI instruction	11
10.6.2 Assign slave channel	11
10.6.3 Principles of data exchange in a multi-master network	11
10.6.4 Data Exchange between master and slave stations	12
10.6.5 Diagnostics	13
10.7 Gateway Function	15
10.7.1 Application	15
10.7.2 Configuration of the Gateway PGU function	16
10.7.3 Configuration of the Gateway Slave port supplementary slave	18
10.7.4 Communication Timing	19
10.8 Other References	20

10 Profi-S-Bus

This example shows how to exchange data, such as Registers and Flags, between the PCDs connected to a Profi-S-Bus network

10.1 Profi-S-Bus network Example

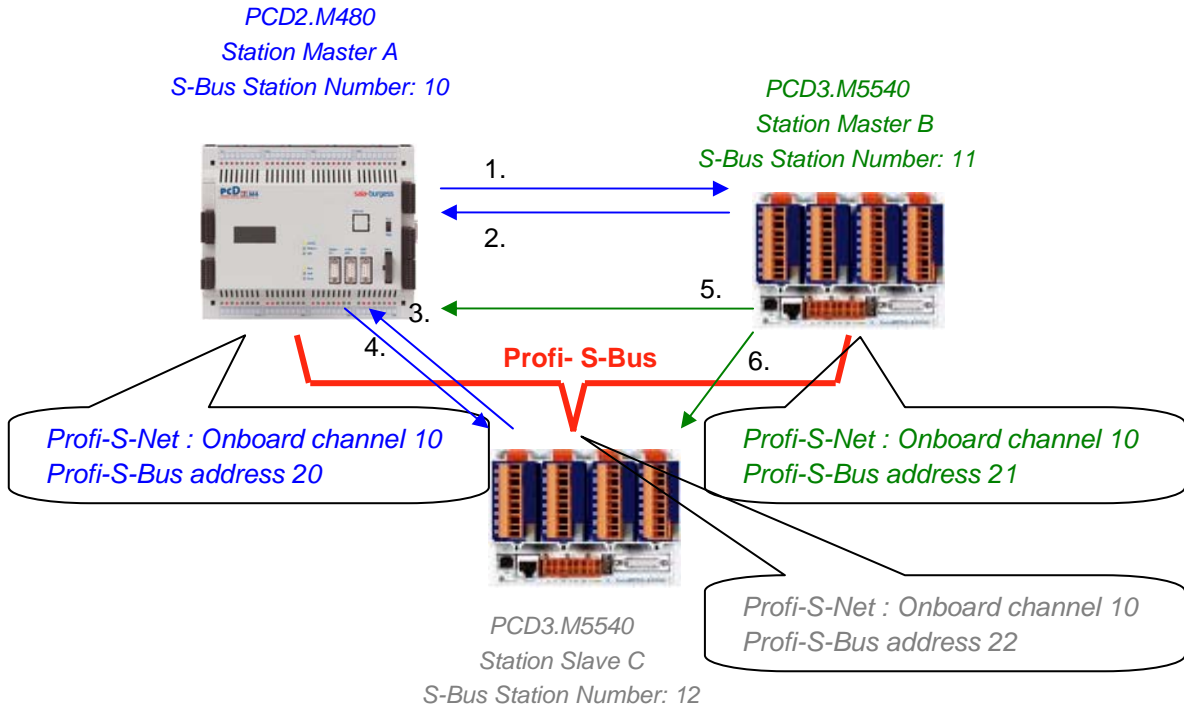

10.2 Examples of the Data Exchange in Profi-S-Bus

	Master with data exchanges	Data on the network	Passive master or slave
	Master station A		Master station B
1	Blinker0 .. 7 F 0 .. 7	Write 8 flags in the Master station B	Station_A.Blinker0 .. 7 F 100 .. 107
2	Master_B.Value100 R 125	Read 1 register in the Master station B	Value100 R 25
			Slave station C
3	Slave_C.Binary0 .. 7 F 100 .. 107	Read 8 flags in the slave station C	Binary0 .. 7 F 20 .. 27
4	Value0 .. 5 R 0 .. 5	Write 6 registers in the slave station C	Master_A.Value0 .. 5 R 20 .. 25
	Master station B		Master station A
5	Temperature1 .. 4 Dynamic registers	Write the temperature measures to the slave C	Master_B.Temperature1 .. 4 R 100 .. 104
			Slave station C
6	Temperature1 .. 4 Dynamic registers	Write the temperature measures to the master A	Master_B.Temperature1 .. 4 R 100 .. 104

10.3 The PG5 Project

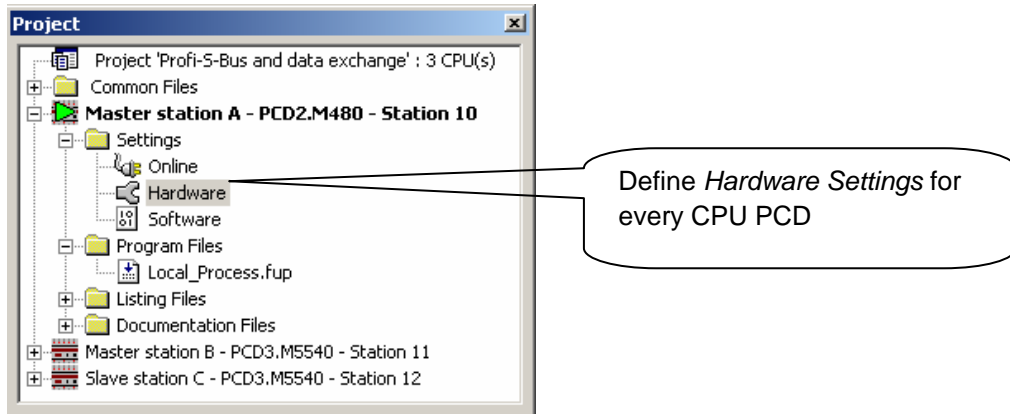

Saia Project Manager

The *Saia Project Manager* shows all the PCD stations in an application's Project, and also the network communication parameters. We will begin with adding a CPU to the Project for each of the Network Stations.

10.4 Hardware Settings master, slaves

The configuration of *Hardware Settings* for a master and Slave are similar.

10.4.1 Define PCD parameters

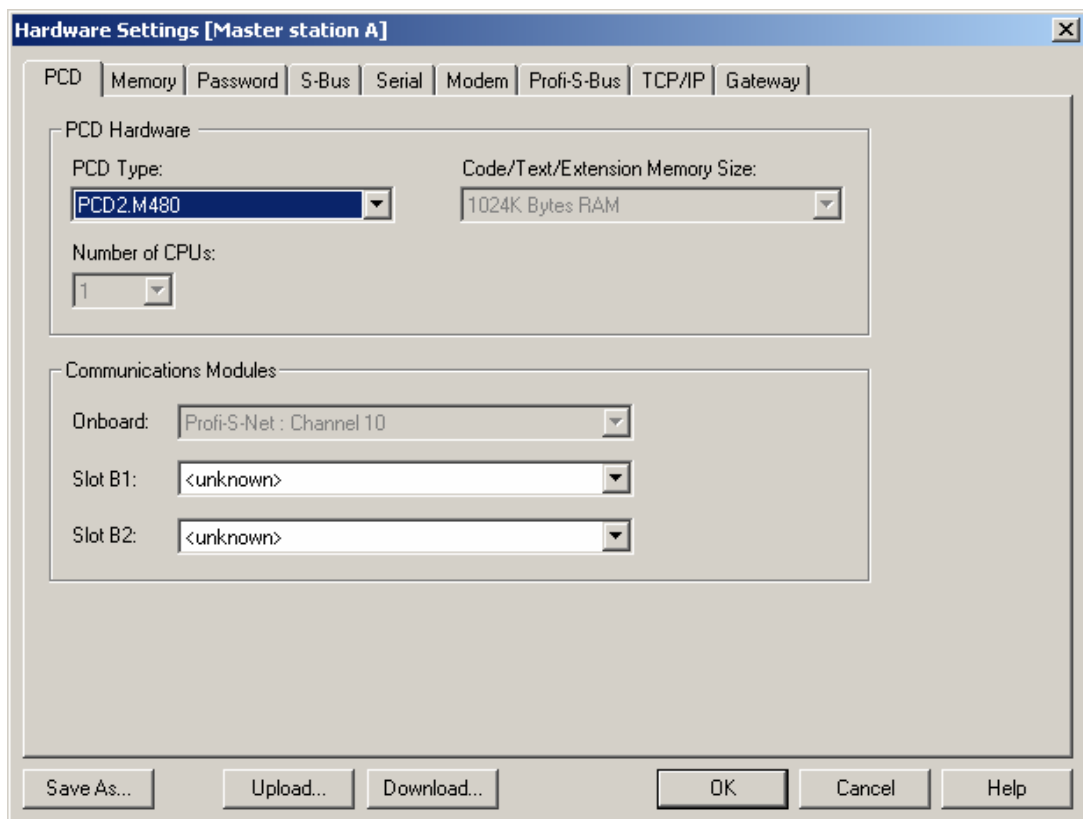

PCD Type

Define the CPU type

Communication Modules

If necessary indicate the type of the communication modules inserted in the slot B1 and B2 of the PCD2.M480.

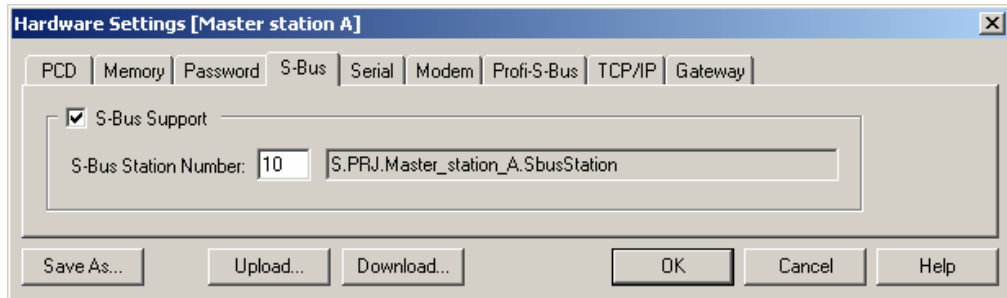
10.4.2 Define S-Bus station number in the Network**S-Bus Station Number**

S-Bus station number is common to all communication channels of the PCD.

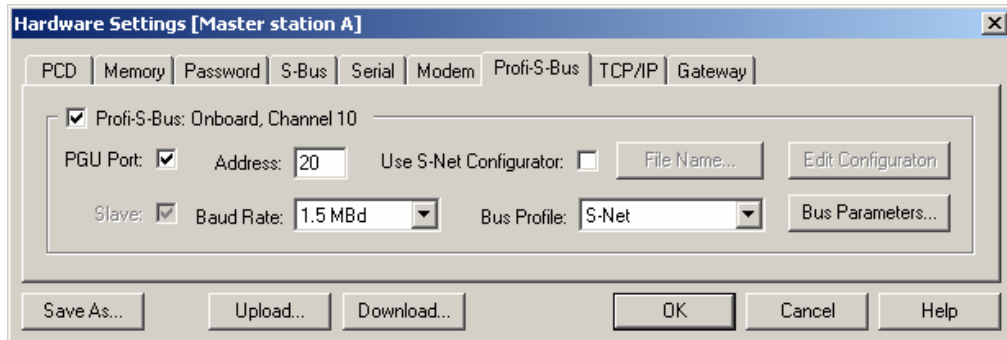
10.4.3 Define communication channel of the Profi-S-Bus**Address**

Profi-S-Bus station number connected to channel.

PGU Port or Slave

Define the channel as slave or PGU. This definition can be accumulated with master function, adding a SASI Fbox in Fupla program.

Slave PGU

Supports data exchange with master stations, supervision systems and terminals. It also supports the PG5 programming tools.

Slave

Supports only data exchange with other master stations, supervision systems and terminals.

Baud Rate

Communication speed must be the same for all stations on the network.

S-Bus Profile

Transmission timings are grouped in three profiles: S-Net, DP or user-defined. With the user-defined profile, you can define your own *timings* using the *Bus Parameter* button. The profile must be identical for all network stations. The S-Net Profile is necessary when using RIO PCD3.T76x in the network.

10.4.4 Download Hardware Settings in the CPU

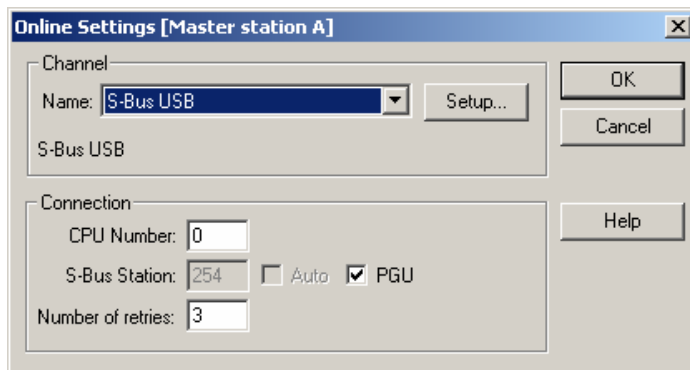

With the new systems PCD2.M480 and PCD3, the *Hardware Settings* can be downloaded via a USB connection. It is necessary just to define *Online Settings* with the channel *Profi-S-Bus PGU*.

Download the parameters to the PCD using *Download* button on the *Hardware Settings* window.

10.5 Fupla Program

10.5.1 Assign the channel using SASI Fbox

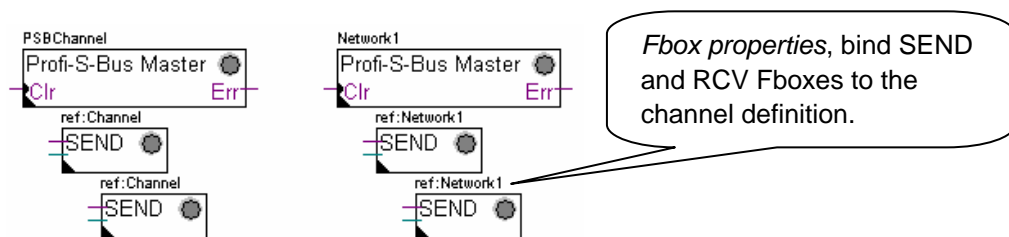

Assignment is done using a SASI Fbox, placed at the beginning of the Fupla File. Each communication network needs its own SASI Fbox, because the parameters are different depending on the network, the same for Master or Slave stations.

If the PCD uses more communication channels, define each channel using corresponding SASI Fbox. Then place the mouse over the SASI Fbox and using the context menu select Fbox properties, define a different *Name* for the Fbox of each channel. This name allows binding the exchange Fboxes SEND and RCV with SASI Fbox corresponding to the channel.

According to the network, the communication channel parameters can be partially defined from the Adjust Window of the SASI Fbox, and to be completed in the *Hardware Settings*.

The Channel number is always defined in the Adjust Window of the SASI FBox. The channel number depends from PCD Hardware and on the communication hardware used: slot B1, B2, serial interface PCD7.F, ...

10.5.2 Assign Master channel

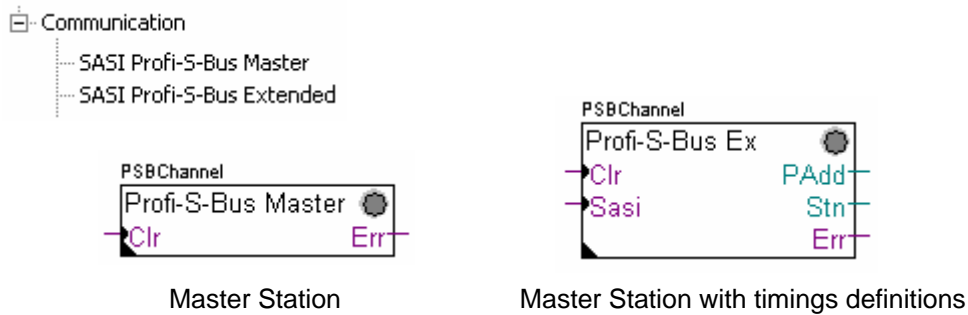

The assignment of the Master channel is done by combining the *Hardware Settings* with one of the Fboxes above.

Only the communication channel and the timings of the Master Channel can be adjusted from the Fbox. Other parameters are all defined in the *Hardware Settings*.

Adjust window parameters:

Channel

Defines the corresponding channel of the serial interface connected in the network. Depends from the PCD and his hardware.

Timing

The Timeout is general defined with the value by default (0) and will be adjusted only for the particular applications (Gateway).

10.5.3 Assign slave channel

No SASI FBox is necessary for the slave station in the Profi-S-Bus network. All definitions necessary are already present in the *Hardware Settings*.

10.5.4 Principles of data exchange in a multi-master network

A multi-master communication network has more than one master station. Master Stations are the only stations authorized to read or write the data of the other master and slave stations. Data exchange between slaves is not allowed.

With a Multi-master communication mode, data exchange is carried out between the masters in the network. Only one master at a time holds a token which authorizes it to exchange data with other master or slave stations on the network. When the master has finished transferring the data, the token is passed to the next master, which is then free to exchange data with the other masters or slaves. The token circulates automatically between the master stations, the slaves never have the token and so cannot read or write the data of other stations in the network.

10.5.5 Data Exchange between master and slave stations

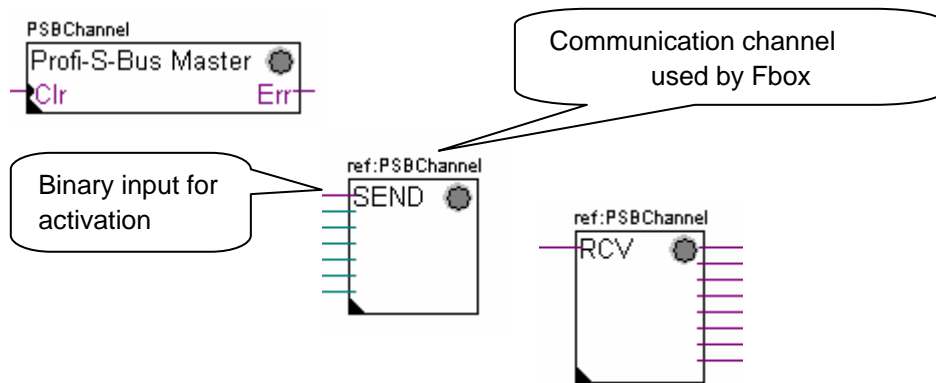

User-controlled data exchange between stations is done using Fupla Fboxes placed on the Fupla pages, chosen the *Fbox Selector*. You will find the Fboxes to write (SEND) or to read (RCV) data packets, and also support different data formats: binary, integer, floating point, Data Block, etc.

The *SEND* or *RCV* Fbox can be resized to increase or decrease the number of inputs and outputs, defining the data packet to be exchanged with another station.

The address of the Communication Channel, used by data transmission Fbox is defined by the symbol shown at the top left of the Fbox, which binds it to the SASI Fbox of the same name in which the channel address is defined. This symbol can be edited by putting the mouse on the Fbox and selecting the context menu's *Fbox Properties Name*.

Each *SEND* and *RCV* Fbox has a binary input for activation of the data exchange. If this input is permanently high, data exchange will repeated as fast as possible. If a short pulse is applied to the input, data exchange will be executed at least once, but it is always possible to force it using the Execute button, or by a Restart Cold the PCD with *Initialization* option of the *adjust window*.

Master station data present at the inputs of the *SEND* Fbox, are sent to the Slave station defined in *adjust window*. Whereas the data present at the output of the *RCV* Fbox comes from the slave station defined by the parameters of the adjust window: address of the slave station, source element and base address.

Only the master stations are programmed with the *SEND* and *RCV* Fboxes! The slave stations can only be assigned with the communication channel.

According to the Fboxes used, the *adjust window* allows the definition of the slave stations to which data can be sent from the master station (*SEND*), or from which slave stations the Master can read data (*RCV*).

Adjust window parameters.

Profi-S-Bus Address

Defines the number of the Profi-S-Bus slave station.

Source, destination station

Defines the number of the S-Bus slave station

Source, destination element

Defines the type of the data to write or read from the slave.

Source, destination address

Defines the start address of the data to write or read in the slave. The number of the exchanged data values depends on the number of the inputs or outputs of the SEND or RCV Fbox.

10.5.6 Diagnostics



If the program is Online, a green or red LED is displayed at the top right of the SASI, SEND or RCV Fbox. Green indicates that the data transmission is OK, red indicates an error.

Correct functionality

All the Fbox are green, data exchange are done correctly.

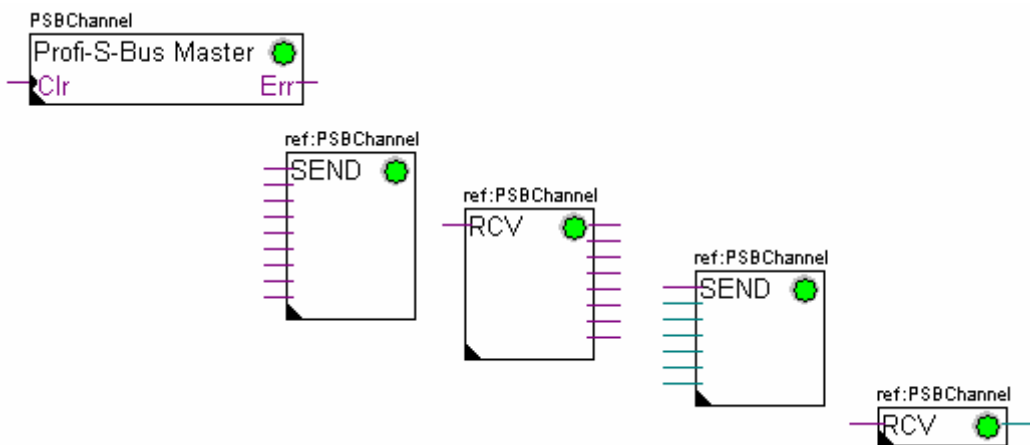

No data can be exchanged in the network

SASI Fbox, SEND and RCV are red; no data can be exchanged in the network.

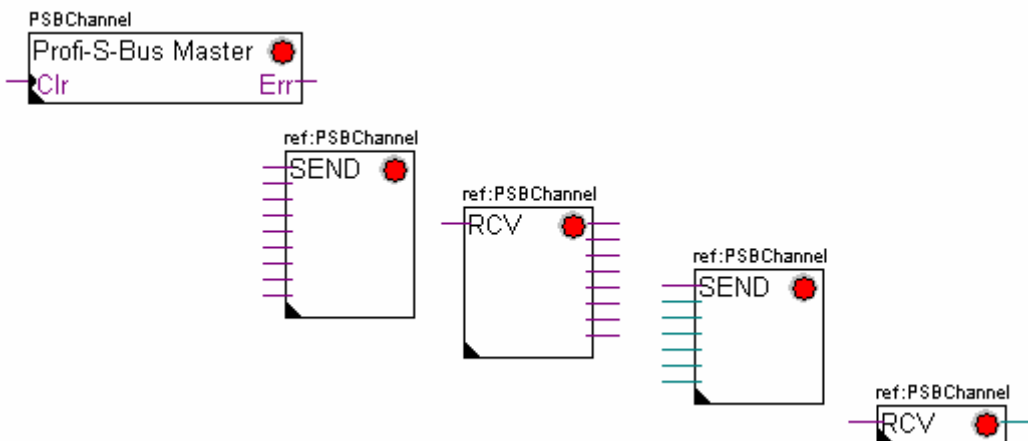

Possible corrective actions in master or slave station:

- Verify the *Hardware Settings*
- Verify that the *Hardware Settings* have been downloaded into the PCD
- Verify that all stations use the same profile: S-Net, DP
- Verify that all stations communicate at the same speed
- Verify that the defined communication channel with the *Hardware Settings* and *SASI* function are identical (same channel number)
- Verify that the PCD is equipped with the necessary communication hardware
- Verify that the stations are connected to the network and are powered on
- Verify the network wiring
- Verify that the firmware version supports Profi-S-Bus

Only some Fboxes do not exchange data

SASI Fbox and some *SEND* and *RCV* Fboxes are red. The Fbox in green exchanges the data correctly

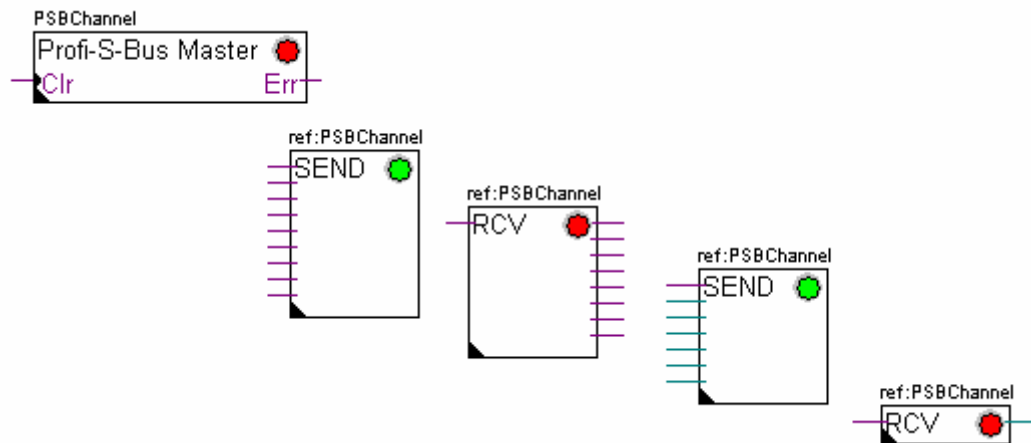
**Possible corrective actions in the master station**

Verify the parameters of the *adjust window* of the red *SEND* and *RCV* Fbox.
Verify that the slave address is present in the network.

Possible corrective actions in the slave station

For every red *SEND* and *RCV* Fbox, view the slave station number and verify the concerned stations.

- Verify if the *Hardware Settings* are defined correctly
- Verify if the PCD is equipped with necessary communication hardware
- Verify if the stations are connected to the network and are powered on
- Verify the network wiring
- Verify if the firmware version supports Profi-S-Bus

Only SASI Fbox is red

Open adjust window of the *SASI* Fbox, and clear the last error using *Clear* button.

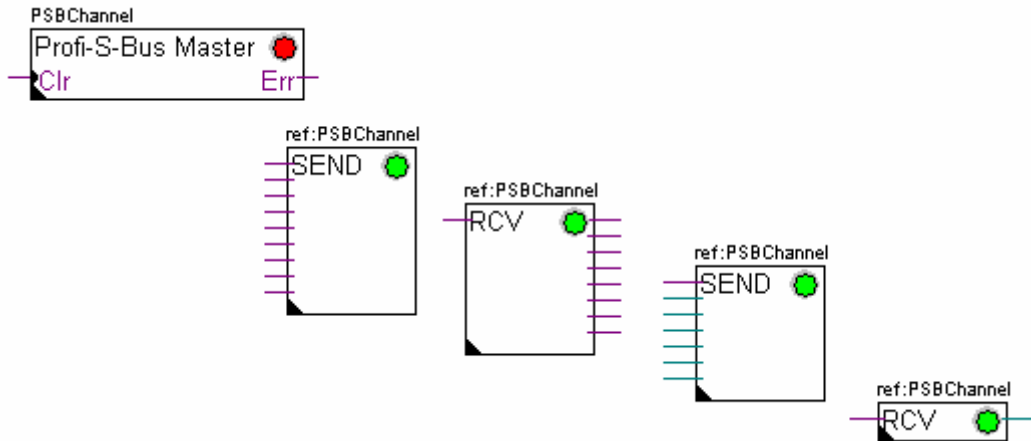

Diagnostic Fbox

If SASI lamp is red, it is always possible to obtain a diagnostic while consulting the adjust window of the *SASI Diagnostic* function. This Fbox should be placed just below *SASI* Fbox.

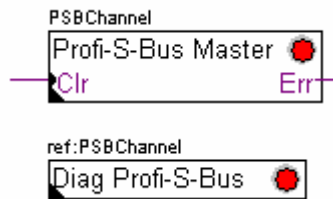

10.6 IL programm

10.6.1 Assign master Channel using SASI instruction

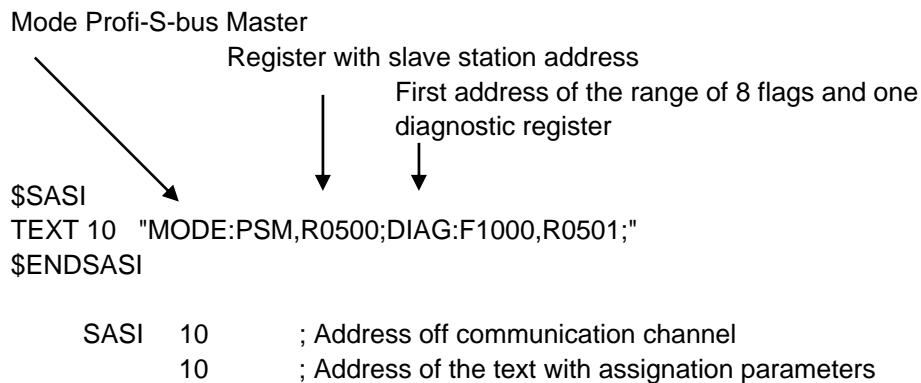

The assignation of the channel is done using SASI instruction, which is placed at the beginning of the program: Graftec initialization sequence or initialization bloc XOB 16.

SASI instruction contains two parameters: communication channel address and address of the text with all the necessary channel parameters.

Text assignation parameters are different from one communication network to other, same as for slave or master station.

If the PCD exploit more communication channels de, each channel must be defined using SASI instruction and assignation text.

Depending of the network, channel parameters can be completed with *Hardware Settings*.

10.6.2 Assign slave channel

No SASI FBox is necessary for the slave station in the Profi-S-Bus network. All definitions necessary are already present in the *Hardware Settings*.

10.6.3 Principles of data exchange in a multi-master network

A multi-master communication network has more than one master station. Master Stations are the only stations authorized to read or write the data of the other master and slave stations. Data exchange between slaves is not allowed.

With a Multi-master communication mode, data exchange is carried out between the masters in the network. Only one master at a time holds a token which authorizes it to exchange data with other master or slave stations on the network. When the master has finished transferring the data, the token is passed to the next master, which is then free to exchange data with the other masters or slaves. The token circulates automatically between the master stations, the slaves never have the token and so cannot read or write the data of other stations in the network.

10.6.4 Data Exchange between master and slave stations

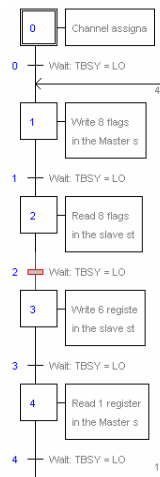

Initial Step: channel assignation

Step: data exchange

Transition: wait end of the data exchange

Data exchange between the stations is the sequential program: The assignment of the communication channel is treated only once, data exchange in the network will be executed only if the previous exchange of the data's is finished. That's why we propose to treat IL data exchange with Graftec Editor.

Initial Step allows assigning the communication channel at the Restart Cold of the PCD.

Other Steps are executed in loop, and step one supports one data package.

Every Step is separated by one Transition which tests diagnostic flag TBSY, and defines if data Exchange is finished. We are authorized to exchange data's defined by step which follows, only if TBSY is Low.

Data Exchange using a Step

Before to exchange data, we must define address of the slave station in the register, which is declared for this by text assignation:

Define the address of the slave station

```
LDL    R 500 ; Register address with the slave station address
        11    ; S-Bus address
```

```
LDH    R 500 ; Register address with slave station address
        21    ; Profi-S-Bus Address
```

Data exchange between the stations is supported using two instructions:
 STXM for writing data in the slave station (*SEND*)
 SRXM for reading data in the slave station (*RCV*)

Each instruction contains four parameters: Channel address, number of data's to exchange, address of the first data source, and the destination.

Write 8 Flags (F 0... F 7) in the slave station (F 200... F 207)

STXM 10 ; Channel address
 8 ; Number of the data's to exchange
 F 0 ; address of the first source data (local Station)
 F 200 ; address of the first destination data (slave Station)

Read a register (R 25) of the slave station (R 125)

SRXM 10 ; Channel address
 1 ; Number of the data's to exchange
 R 25 ; address of the first source data (local Station)
 R 125 ; address of the first destination data (slave Station)

Note:

Only the master stations are programmed with STXM and SRXM ! The slave stations must only be assigned with the communication channel.

Waiting the transmission end de using the transition

STL F 1003 ; Verify that TBSY is in Low state

Le Assignment text defines a range of 8 diagnostic flags for communication. Third flag will go in the high state during the data transmit, and in low state when exchange is finished.

10.6.5 Diagnostics**Channel assinations**

In the case of the communication problem, verify if the channel assignation is done correctly. Analyse the program step by step, and verify that the SASI instruction doesn't display a flag error. If the channel assignation isn't done correctly, then the communication will not work.

Possible corrective actions in master or slave station:

- Verify the *Hardware Settings*
- Verify that the *Hardware Settings* have been downloaded into the PCD
- Verify that all stations use the same profile: S-Net, DP
- Verify that all stations communicate at the same speed
- Verify that the defined communication channel with the *Hardware Settings* and SASI instruction are identical (same channel number)
- Verify that the PCD is equipped with the necessary communication hardware
- Verify that the stations are connected to the network and are powered on
- Verify the network wiring
- Verify that the firmware version supports Profi-S-Bus

Data's are not exchanged in the network

Assignment Text defines a range with 8 diagnostic flags for the communication, Fifth Flag (*TDIA: Transmitter diagnostic*) will go in the high state during the data transmit error. Step by step test of the communication program, allows determining the instructions STXM and SRXM in error.

Attention: if the communication error occurs, then the diagnostic flag TDIA stays in high state, until the diagnostic register will not be reset to zero.

Possible corrective actions in the master station

Verify the parameters of the instructions STXM and SRXM in error. Verify that the slave address is present in the network.

Possible corrective actions in the slave station

For every instruction STXM and SRXM in error, read the slave station number and verify concerned stations.

- Verify if the *Hardware Settings* are defined correctly
- Verify if the PCD is equipped with necessary communication hardware
- Verify if the stations are connected to the network and are powered on
- Verify the network wiring
- Verify if the firmware version supports Profi-S-Bus

Diagnostic register

Diagnostic register can give us more information's about the nature the communication error. Display the binary content of the register and compare it with the descriptions of the PCD manual or the communication network manual.

10.7 Gateway Function

The *Gateway* feature is commonly used to allow two different communication networks to communicate together, or adapt a programming tool (PG5) or a supervision system (Visi+) to use a different network than the one usually supported.

10.7.1 Application

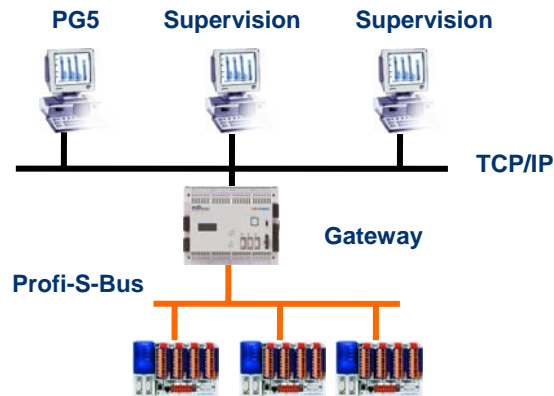

The *Gateway* function creates a bridge between two networks, for example to link an Ethernet network with a Profi-S-Bus network. In this way the PCD systems exchange data on a common bus, specific to the automation field and separated from information network of the company. But the PCs running the PG5 software or the supervision system Visi+ can exchange still data with the PCDs.

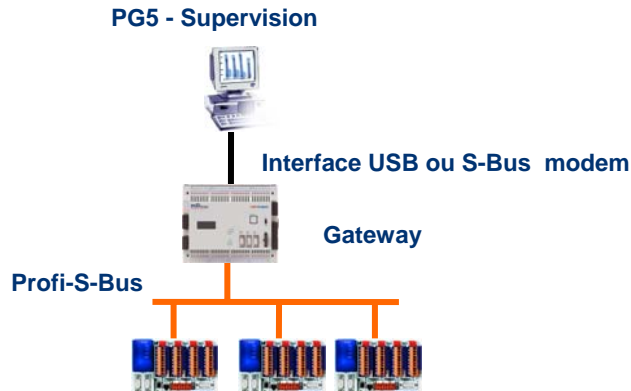

The *Gateway* function can be used as an interface between a communications network and the external world. For example, to make modem or USB communication interfaces.

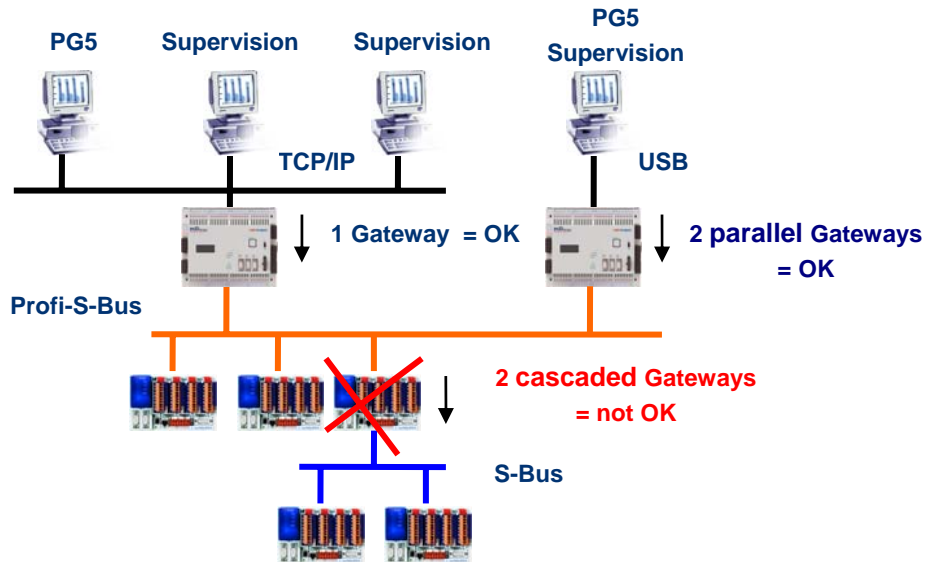

To respect the communication timings, we cannot define two cascaded Gateways functions. But it is possible to define two parallel Gateways on the same network.

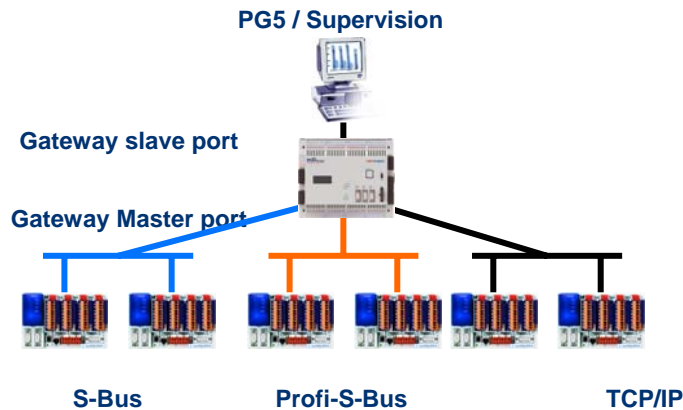

If necessary, a Gateway can make a bridge between to several communication sub networks.

10.7.2 Configuration of the Gateway PGU function

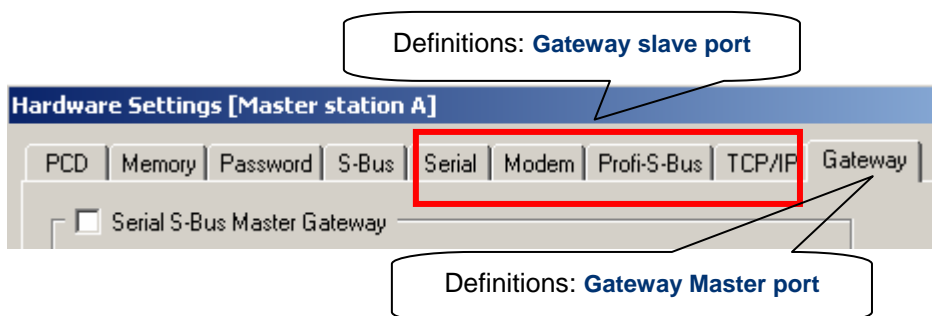

It is easy to configure the *Gateway* function; it doesn't need any program, only some parameters in the PCD *Hardware Settings*.

Generally, only a *Gateway Slave Port* and a *Gateway Master Port* should be defined, then all is automatically supported by *Gateway* function.

If the message received by the *Gateway Slave Port* is not for the local station (the *Gateway*), then data is re-transmitted via one of the sub-networks connected to the *Gateway Master Port*, according to the address ranges defined for the sub-network.

Example: Gateway USB, Profi-S-Bus

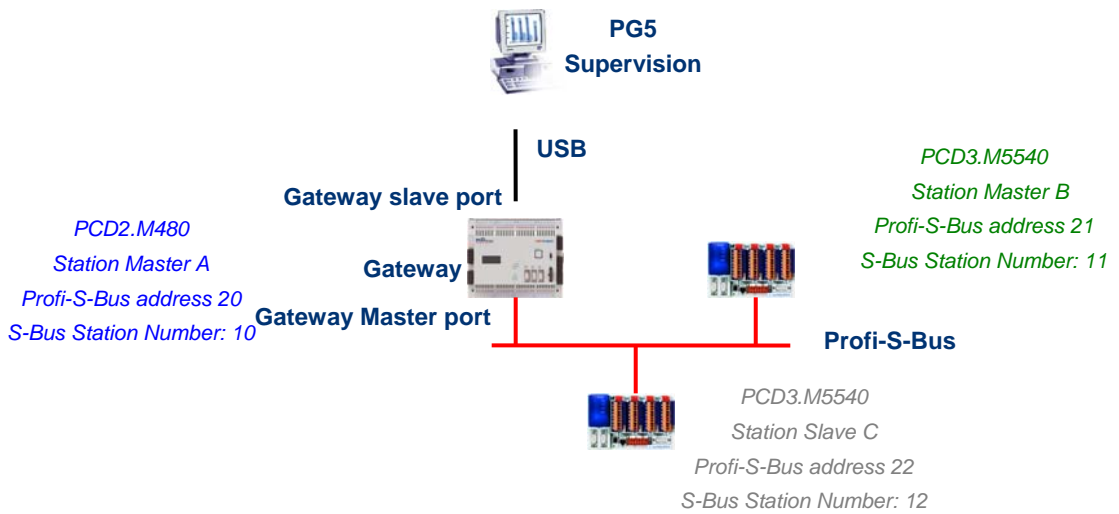

Hardware Settings of the Master A station

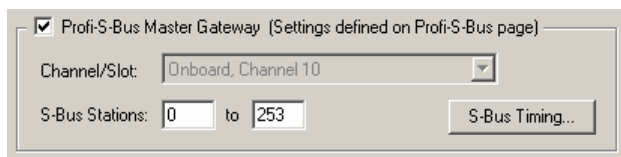

The USB Gateway is an exception; it doesn't need any parameters for the *Gateway Slave port*, only the *Gateway Master port* must be defined. (Don't forget to download the new configuration into Master A!)

Online Settings of the project CPU

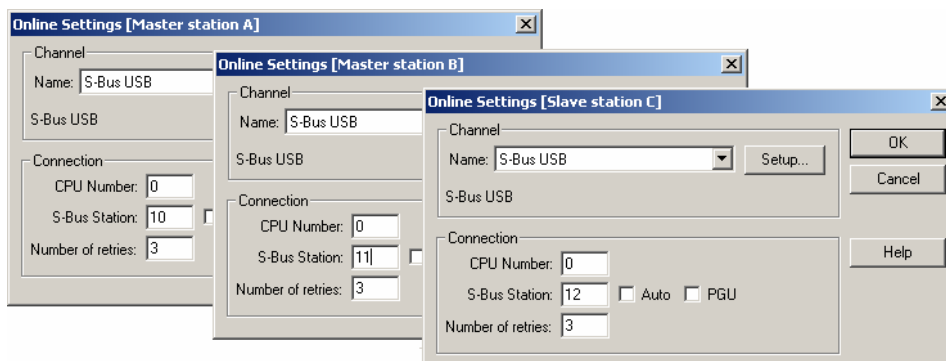

To make a USB communication with each PCD, the *Online Settings* should be configured with USB channel and S-Bus station number.

Testing the functionality of the Gateway Function

Slave station C - PCD3.M5540 - Station 12

Activate one of the CPU, *Master B* or *Slave C*, of the project and Go Online for testing the communication with the station.



If necessary, the *Online Configurator* allows you to verify the station number online. It is also possible to download the program in the active CPU and to test it, staying always connected via USB cable to station *Master A*

Master station B - PCD3.M5540 - Station 11

To communicate with another network station, activate the CPU and Go Online.

Remark:

With the *Gateway* feature, only the slave S-Bus station number is defined, the Profi-S-Bus station number is not taken into account because the telegrams are addressed to all Profi-S-Bus stations (Broadcast).

10.7.3 Configuration of the Gateway Slave port supplementary slave

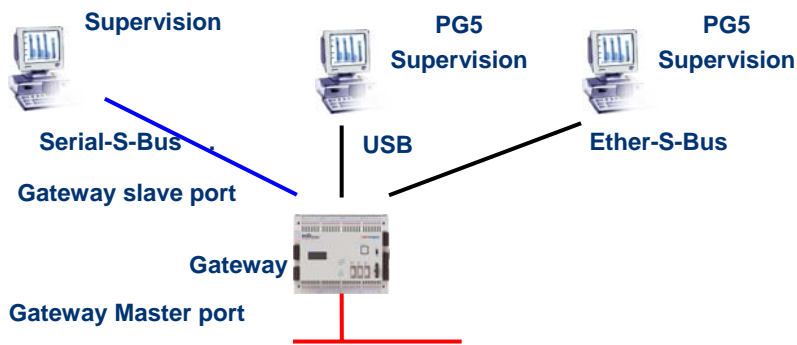

The Gateway Slave port is a way to access the network from outside. If necessary, a second or the third *Gateway Slave port* can be defined.

Hardware Settings

In general, the PCD supports only one slave PGU channel. But the new PCD2.M480 and PCD3.Mxxxx controllers may support more PGU port on the same PCD. The configuration of the second Gateway Slave PGU is supported by the *Hardware Settings*.

Example: add a second Gateway Ether-S-Bus, Profi-S-Bus

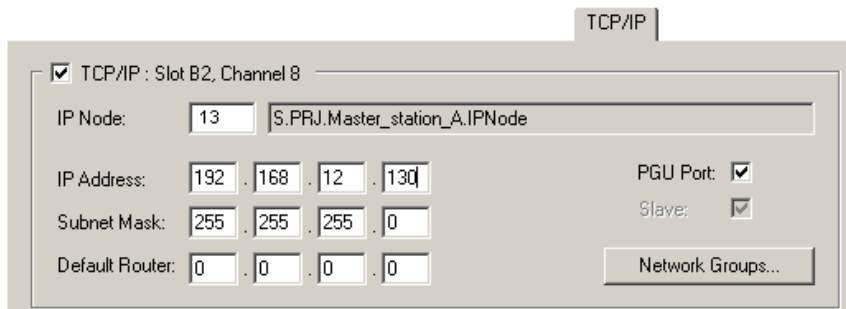

The second *Gateway Slave port PGU* is added, configuring the *Hardware Settings* with the node and TCP/IP address. If the controller is a PCD2.M480, the communication module should also be defined in the PCD's Slot B2 with PCD7.F65x (Ethernet module).

Fupla or IL Program

With old PCDs and also the new PCD2.M480 and PCD3.Mxxxx, it is possible to use a supplementary SASI Fbox/instruction and add a second *Gateway Slave port*.

this *Gateway slave port*, without PGU functionality, will not support the PG5 programming tools, but only a supervision system terminal. Only reading and writing PCD data are supported: registers, flags, etc.

Example Fupla: add a third Serial-S-Bus, Profi-S-Bus



The adjust *Gateway* parameter then must be defined with option Yes. According to channel type, the parameters of the adjust window should also correctly defined.

Example IL : add a third Serial-S-Bus, Profi-S-Bus

Use the following text to assign the channel:

```
$SASI
TEXT 11 "UART:9600; MODE:GS2; DIAG:F1110, R0501;"
$ENDSASI
```

Transmission speed
Mode S-Bus Gateway Slave Data mode
Flag and diagnostic register

10.7.4 Communication Timing

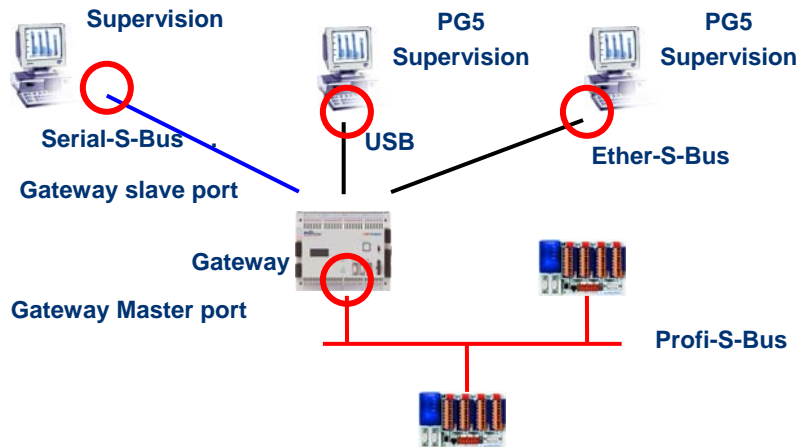

Generally the communication *timing* is defined with default values and this works correctly. But the use of the *Gateway* feature increases the times of the reactions necessary for the data exchange. It is then sometimes necessary to adjust the

timeout of the master stations which use the *Gateway*. The above picture shows which are the master channels whose timeouts must be adjusted.

To adjust the *Timeout* of the PG5, use *Online Settings* of the *Master Station A*:

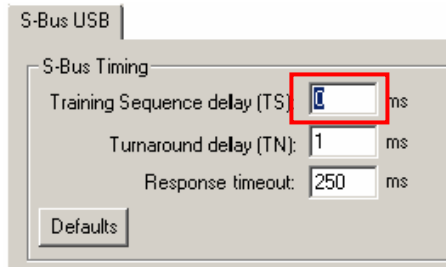

To adjust the *Timeout* of the data exchange program to the PCD, use Fbox: *SASI/ Profi-S-Bus Extended*



10.8 Other References

For more information's, you can also refer to the following manuals:

- Instruction Guide 26/133
- Profi-S-Bus (in preparation)
- Example of the project Profi-S-Bus installed with your PG5

Contents

CONTENTS	1
11 ETHER-S-BUS	2
11.1 Ether-S-Bus network Example	2
11.2 Examples of the Data Exchange in Ether-S-Bus	2
11.3 The PG5 Project	3
11.4 Hardware Settings master, slaves	3
11.4.1 Define PCD parameters	3
11.4.2 Define S-Bus station number in the Network	4
11.4.3 Define communication channel of the Ether-S-Bus	4
11.4.4 Download Hardware Settings in the CPU	5
11.5 Fupla Program	5
11.5.1 Assign the channel using SASI Fbox	5
11.5.2 Assign Master channel	6
11.5.3 Assign slave channel	6
11.5.4 Principles of data exchange in a multi-master network	6
11.5.5 Data Exchange between master and slave stations	7
11.5.6 Diagnostics	8
11.6 IL program	11
11.6.1 Assign the master channel using SASI instruction	11
11.6.2 Assign slave channel	11
11.6.3 Principles of data exchange in a multi-master network	11
11.6.4 Data Exchange between master and slave stations	12
11.6.5 Diagnostics	13
11.7 Gateway Function	15
11.7.1 Application	15
11.7.2 Configuration of the Gateway PGU function	16
11.7.3 Configuration of the Gateway Slave port supplementary slave	18
11.7.4 Communication Timing	20
11.8 Other References	20

11 Ether-S-Bus

This example shows how to exchange data, such as Registers and Flags, between the PCDs connected to an Ether-S-Bus network

11.1 Ether-S-Bus network Example

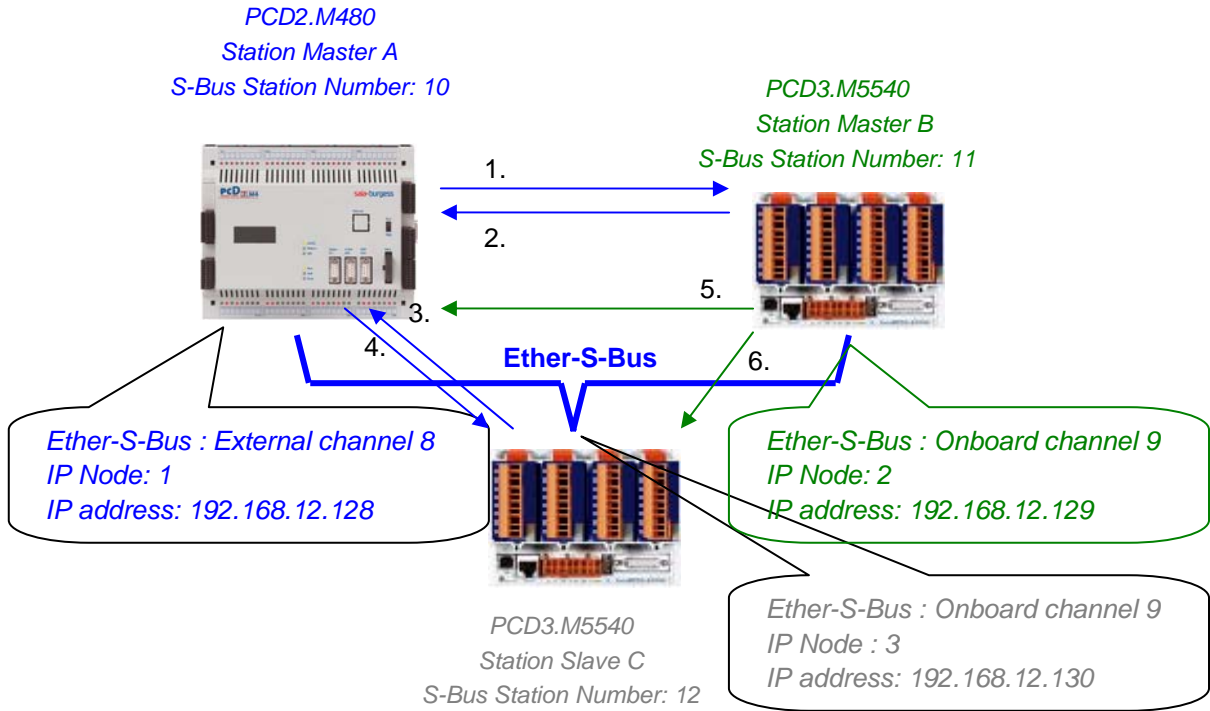

11.2 Examples of the Data Exchange in Ether-S-Bus

	Master with data exchanges	Data on the network	Passive master or slave
	Master station A		Master station B
1	Blinker0 .. 7 F 0 .. 7	Write 8 flags in the Master station B	Station_A.Blinker0 .. 7 F 100 .. 107
2	Master_B.Value100 R 125	Read 1 register in the Master station B	Value100 R 25
			Slave station C
3	Slave_C.Binary0 .. 7 F 100 .. 107	Read 8 flags in the slave station C	Binary0 .. 7 F 20 .. 27
4	Value0 .. 5 R 0 .. 5	Write 6 registers in the slave station C	Master_A.Value0 .. 5 R 20 .. 25
	Master station B		Master station A
5	Temperature1 .. 4 Dynamic registers	Write the temperature measures to the slave C	Master_B.Temperature1 .. 4 R 100 .. 104
			Slave station C
6	Temperature1 .. 4 Dynamic registers	Write the temperature measures to the master A	Master_B.Temperature1 .. 4 R 100 .. 104

11.3 The PG5 Project

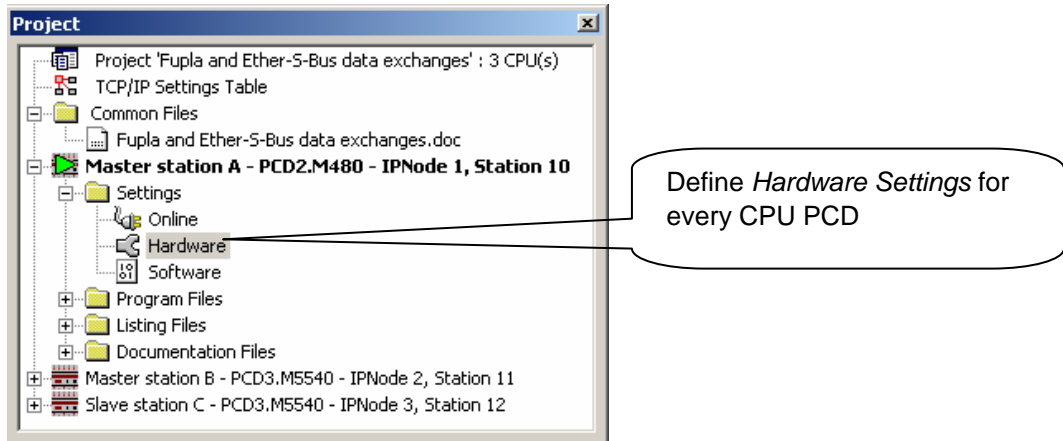

Saia Project Manager

The *Saia Project Manager* shows all the PCD stations in an application's Project, and also the network communication parameters. We will begin with adding a CPU to the Project for each of the Network Stations.

11.4 Hardware Settings master, slaves

The configuration of *Hardware Settings* for a master and Slave are similar.

11.4.1 Define PCD parameters

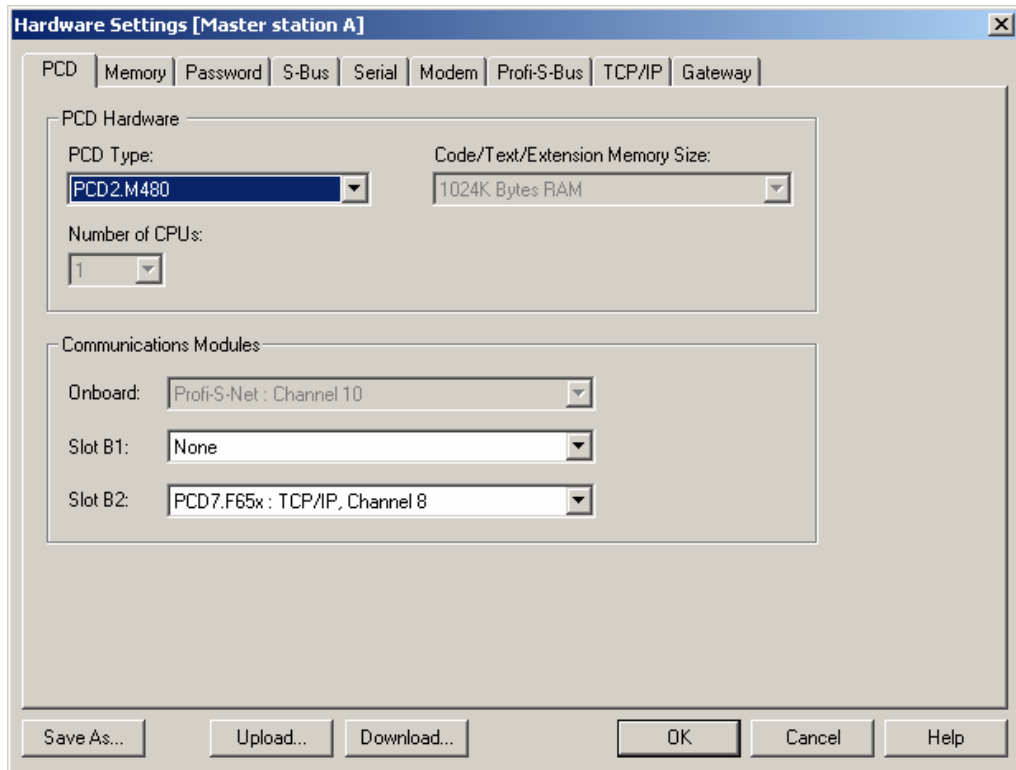

PCD Type

Define the CPU type

Communication Modules

If necessary indicate the type of the communication modules inserted in the slot B1 and B2 of the PCD2.M480.

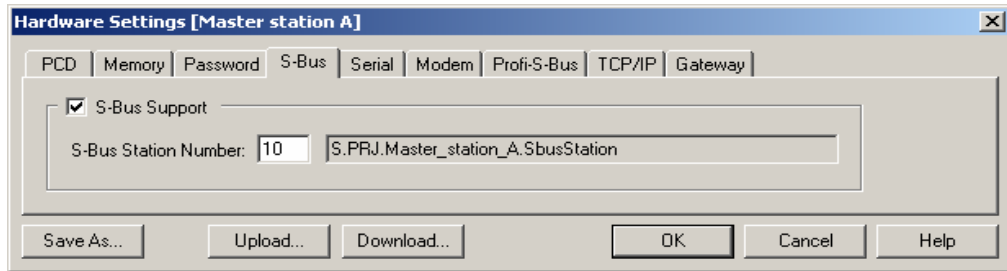
11.4.2 Define S-Bus station number in the Network**S-Bus Station Number**

S-Bus station number is common to all communication channels of the PCD.

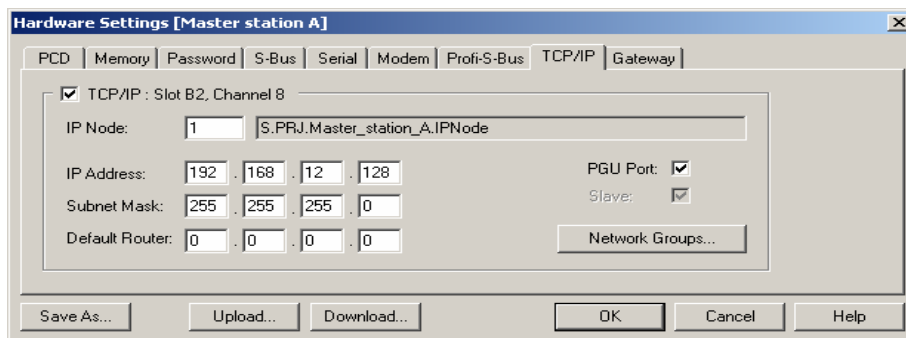
11.4.3 Define communication channel of the Ether-S-Bus**IP Address**

Ether-S-Bus station number connected to channel.

IP Node

TCP/IP node number. The Node is used in the SEND and RCV Fbox-es to define a Slave station with witch the data's has to be exchanged.

PGU Port or Slave

Define the channel as slave or PGU. This definition can be accumulated with master function, adding a SASI Fbox in Fupla program.

Slave PGU

Supports data exchange with master stations, supervision systems and terminals. It also supports the PG5 programming tools.

Slave

Supports only data exchange with other master stations, supervision systems and terminals.

11.4.4 Download Hardware Settings in the CPU

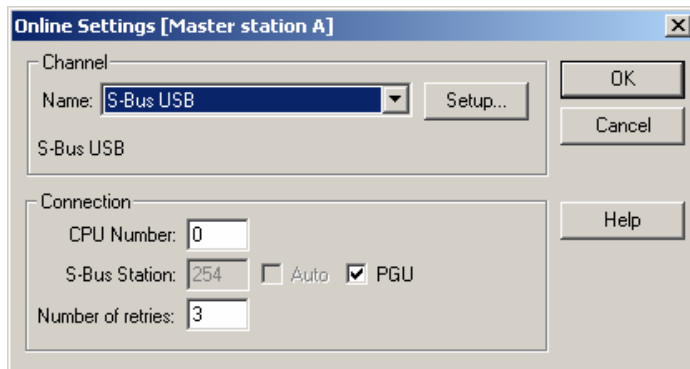

With the new systems PCD2.M480 and PCD3, the *Hardware Settings* can be downloaded via a USB connection. It is necessary just to define *Online Settings* with the channel *Ether-S-Bus PGU*.

Download the parameters to the PCD using *Download* button on the *Hardware Settings* window.

11.5 Fupla Program

11.5.1 Assign the channel using SASI Fbox

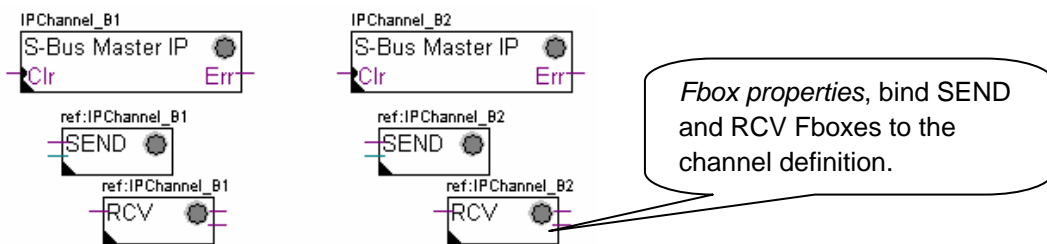

Assignment is done using a SASI Fbox, placed at the beginning of the Fupla File. Each communication network needs its own SASI Fbox, because the parameters are different depending on the network, the same for Master or Slave stations.

If the PCD uses more communication channels, define each channel using corresponding SASI Fbox. Then place the mouse over the SASI Fbox and using the context menu select Fbox properties, define a different *Name* for the Fbox of each channel. This name allows binding the exchange Fboxes SEND and RCV with SASI Fbox corresponding to the channel.

According to the network, the communication channel parameters can be partially defined from the Adjust Window of the SASI Fbox, and to be completed in the *Hardware Settings*.

The Channel number is always defined in the Adjust Window of the SASI FBox. The channel number depends from PCD Hardware and on the communication hardware used: slot B1, B2, serial interface PCD7.F, ...

11.5.2 Assign Master channel

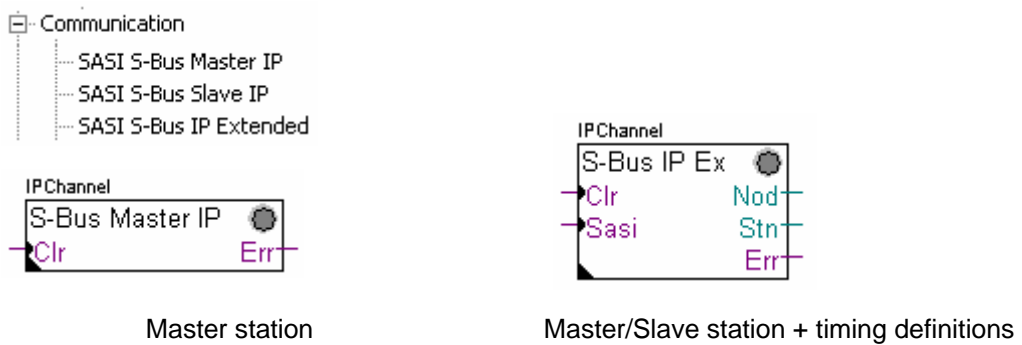

The assignment of the Master channel is done by combining the *Hardware Settings* with one of the Fboxes above.

Adjust window parameters:

Channel

Defines the channel number connected in the network. Depends from the PCD and his hardware.

Timing

The Timeout is general defined with the value by default (0) and will be adjusted only for the particular applications (Gateway).

11.5.3 Assign slave channel

No SASI FBox is necessary for the slave station in the Ether-S-Bus network. All definitions necessary are already present in the *Hardware Settings*.

11.5.4 Principles of data exchange in a multi-master network

A multi-master communication network has more than one master station. Master Stations are the only stations authorized to read or write the data of the other master and slave stations. Data exchange between slaves is not allowed.

With a Multi-master communication mode, data exchange is carried out between the masters in the network. Only one master at a time holds a token which authorizes it to exchange data with other master or slave stations on the network. When the master has finished transferring the data, the token is passed to the next master, which is then free to exchange data with the other masters or slaves. The token circulates automatically between the master stations, the slaves never have the token and so cannot read or write the data of other stations in the network.

11.5.5 Data Exchange between master and slave stations

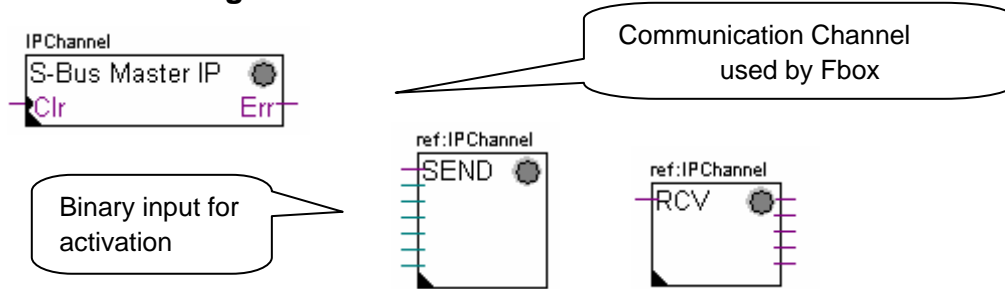

User-controlled data exchange between stations is done using Fupla Fboxes placed on the Fupla pages, chosen the *Fbox Selector*. You will find the Fboxes to write (SEND) or to read (RCV) data packets, and also support different data formats: binary, integer, floating point, Data Block, etc.

The *SEND* or *RCV* Fbox can be resized to increase or decrease the number of inputs and outputs, defining the data packet to be exchanged with another station.

The address of the Communication Channel, used by data transmission Fbox is defined by the symbol shown at the top left of the Fbox, which binds it to the SASI Fbox of the same name in which the channel address is defined. This symbol can be edited by putting the mouse on the Fbox and selecting the context menu's *Fbox Properties Name*.

Each *SEND* and *RCV* Fbox has a binary input for activation of the data exchange. If this input is permanently high, data exchange will repeated as fast as possible. If a short pulse is applied to the input, data exchange will be executed at least once, but it is always possible to force it using the Execute button, or by a Restart Cold the PCD with *Initialization* option of the *adjust window*.

Master station data present at the inputs of the *SEND* Fbox, are sent to the Slave station defined in *adjust window*. Whereas the data present at the output of the *RCV* Fbox comes from the slave station defined by the parameters of the *adjust window*: address of the slave station, source element and base address.

Only the master stations are programmed with the *SEND* and *RCV* Fboxes! The slave stations can only be assigned with the communication channel.

According to the Fboxes used, the *adjust window* allows the definition of the slave stations to which data can be sent from the master station (*SEND*), or from which slave stations the Master can read data (*RCV*).

Adjust window parameters.

IP Node

Defines the node number of the Ether-S-Bus slave station.

Source, destination station

Defines the number of the S-Bus slave station

Source, destination element

Defines the type of the data to write or read from the slave.

Source, destination address

Defines the start address of the data to write or read in the slave. The number of the exchanged data values depends on the number of the inputs or outputs of the SEND or RCV Fbox.

11.5.6 Diagnostics



If the program is Online, a green or red LED is displayed at the top right of the SASI, SEND or RCV Fbox. Green indicates that the data transmission is OK, red indicates an error.

Correct functionality

All the Fbox are green, data exchange are done correctly.

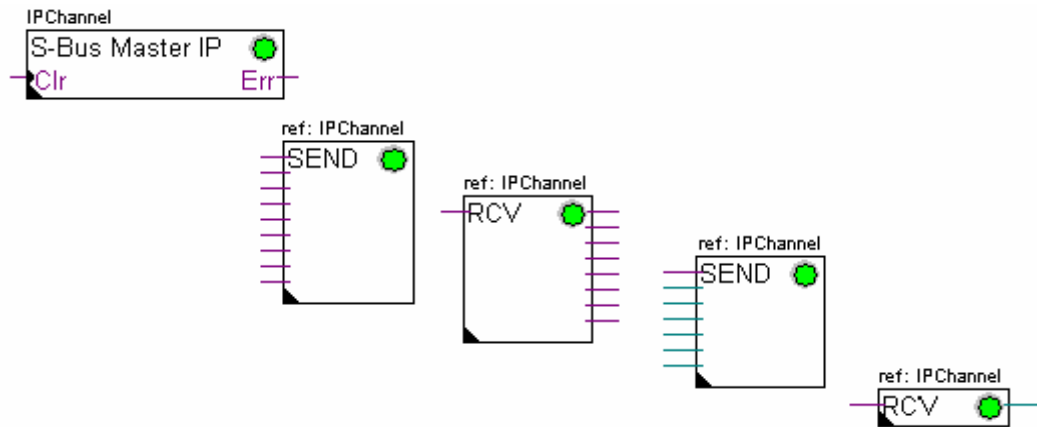

No data can be exchanged in the network

SASI Fbox, SEND and RCV are red; no data can be exchanged in the network.

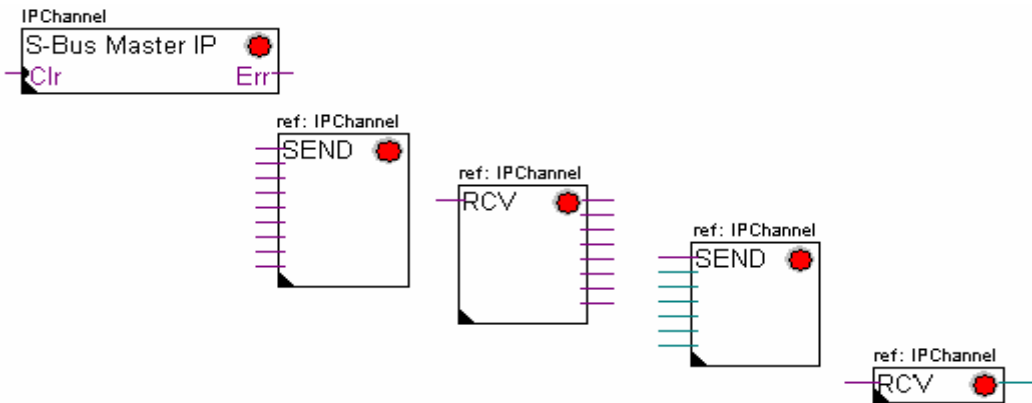

Possible corrective actions in master or slave station:

- Verify the *Hardware Settings*
- Verify that the *Hardware Settings* have been downloaded into the PCD
- Verify that the communication Channel defined with the Hardware Settings, and SASI function are identical (same channel number)
- Verify that the PCD is equipped with the necessary communication hardware
- Verify that the stations are connected to the network and are powered on
- Verify the network wiring
- Verify that the firmware version supports Ether-S-Bus

Only some Fboxes do not exchange data

SASI Fbox and some *SEND* and *RCV* Fboxes are red. The Fbox in green exchanges the data correctly

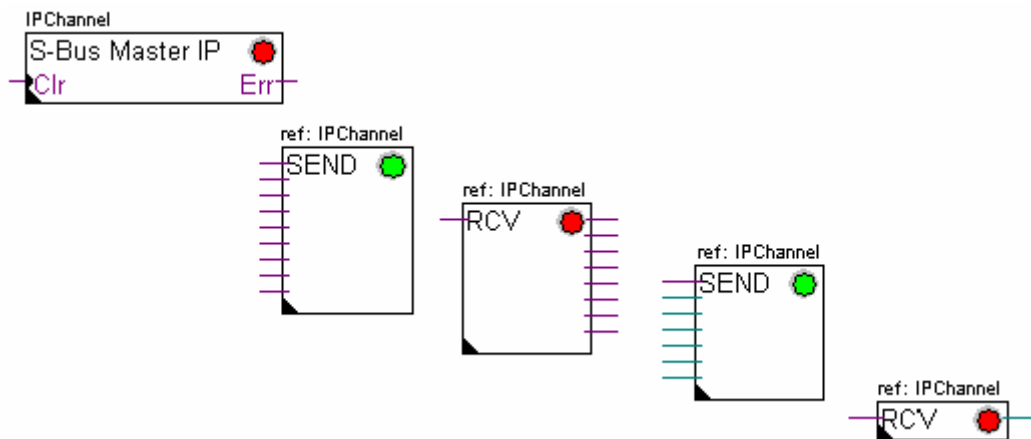
**Possible corrective actions in the master station**

Verify the parameters of the *adjust window* of the red *SEND* and *RCV* Fbox.
Verify that the slave address is present in the network.

Possible corrective actions in the slave station

For every red *SEND* and *RCV* Fbox, view the slave station number and verify the concerned stations.

- Verify if the *Hardware Settings* are defined correctly
- Verify if the PCD is equipped with necessary communication hardware
- Verify if the stations are connected to the network and are powered on
- Verify the network wiring
- Verify if the firmware version supports Ether-S-Bus

Only SASI Fbox is red

Open adjust window of the *SASI* Fbox, and clear the last error using *Clear* button.

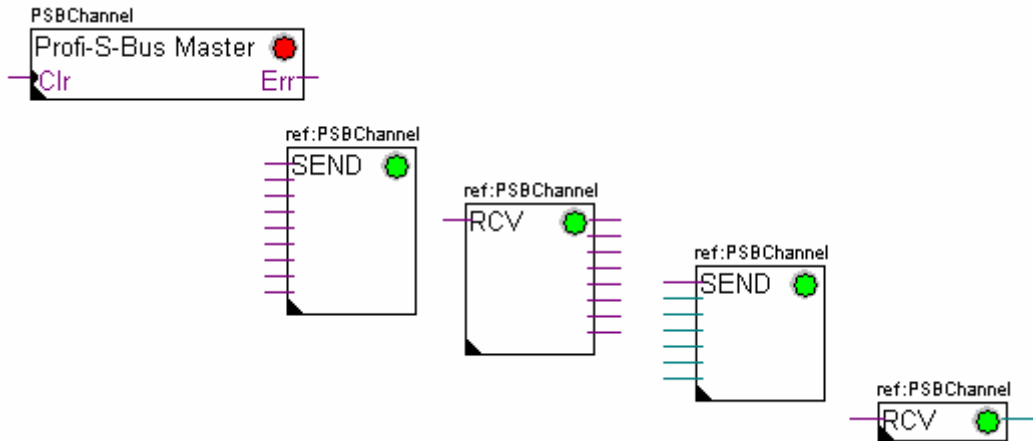

Diagnostic Fbox

If SASI lamp is red, it is always possible to obtain a diagnostic while consulting the adjust window of the *SASI Diagnostic* function. This Fbox should be placed just below *SASI* Fbox.

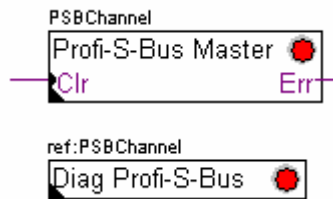

11.6 IL program

11.6.1 Assign the master channel using SASI instruction

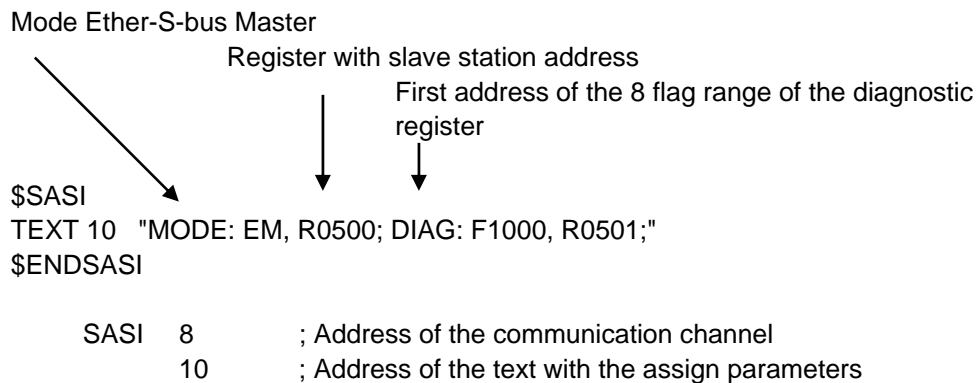

Channel assignation is done using SASI instruction, which is placed in the beginning of the program: initialization of the Graftec sequence, or initialization block XOB 16.

SASI instruction contains two parameters: The address of the communication channel and the text address, with all necessary channel parameters.

The parameters of the assignation text are different from one network to other, also for master or slave station.

If the PCD exploits more communication channels, define each channel using SASI instruction and assignation text.

According to network, channel parameters can be completed with *Hardware Settings*.

11.6.2 Assign slave channel

No SASI instruction is necessary for the slave station in the Ether-S-Bus network. All definitions necessary are already present in the *Hardware Settings*.

11.6.3 Principles of data exchange in a multi-master network

A multi-master communication network has more than one master station. Master Stations are the only stations authorized to read or write the data of the other master and slave stations. Data exchange between slaves is not allowed.

With a Multi-master communication mode, data exchange is carried out between the masters in the network. Only one master at a time holds a token which authorizes it to exchange data with other master or slave stations on the network. When the master has finished transferring the data, the token is passed to the next master, which is then free to exchange data with the other masters or slaves. The token circulates automatically between the master stations, the slaves never have the token and so cannot read or write the data of other stations in the network.

11.6.4 Data Exchange between master and slave stations

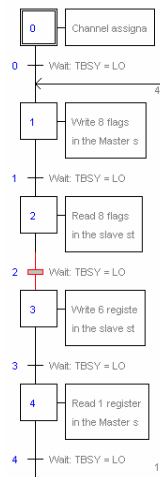

Initial Step: channel assignation

Step: data exchange

Transition: wait end of the data exchange

Data exchange between the stations is the sequential program: The assignation of the communication channel is treated only once, data exchange in the network will be executed only if the previous exchange of the data's is finished. That's why we propose to treat IL data exchange with Grafcet Editor.

Initial Step allows assigning the communication channel at the Restart Cold of the PCD.

Other Steps are executed in loop, and step one supports one data package.

Every Step is separated by one Transition which tests diagnostic flag TBSY, and defines if data Exchange is finished. We are authorized to exchange data's defined by step which follows, only if TBSY is Low.

Data Exchange using a Step

Before to exchange data, we must define address of the slave station in the register, which is declared for this by text assignation:

Define the address of the slave station

```
LDL    R 500 ; Register address with the slave station address
      11    ; S-Bus address
```

```
LDH    R 500 ; Register address with slave station address
      2     ; IP Node
```

Data exchange between the stations is supported using two instructions:
 STXM for writing data in the slave station (*SEND*)
 SRXM for reading data in the slave station (*RCV*)

Each instruction contains four parameters: Channel address, number of data's to exchange, address of the first data source, and the destination.

Write 8 Flags (F 0... F 7) in the slave station (F 200... F 207)

STXM 8 ; Channel address
 8 ; Number of the data's to exchange
 F 0 ; address of the first source data (local Station)
 F 200 ; address of the first destination data (slave Station)

Read a register (R 25) of the slave station (R 125)

SRXM 8 ; Channel address
 1 ; Number of the data's to exchange
 R 25 ; address of the first source data (local Station)
 R 125 ; address of the first destination data (slave Station)

Note:

Only the master stations are programmed with STXM and SRXM ! The slave stations must only be assigned with the communication channel.

Waiting the transmission end de using the transition

STL F 1003 ; Verify that TBSY is in Low state

Le Assignment text defines a range of 8 diagnostic flags for communication. Third flag will go in the high state during the data transmit, and in low state when exchange is finished.

11.6.5 Diagnostics**Channel assignments**

In the case of the communication problem, verify if the channel assignment is done correctly. Analyse the program step by step, and verify that the SASI instruction doesn't display a flag error. If the channel assignment isn't done correctly, then the communication will not work.

Possible corrective actions in master or slave station:

- Verify the *Hardware Settings*
- Verify that the *Hardware Settings* have been downloaded into the PCD
- Verify that all stations use the same profile: S-Net, DP
- Verify that all stations communicate at the same speed
- Verify that the defined communication channel with the *Hardware Settings* and SASI instruction are identical (same channel number)
- Verify that the PCD is equipped with the necessary communication hardware
- Verify that the stations are connected to the network and are powered on
- Verify the network wiring
- Verify that the firmware version supports Ether-S-Bus

Data's are not exchanged in the network

Assignment Text defines a range with 8 diagnostic flags for the communication, Fifth Flag (*TDIA: Transmitter diagnostic*) will go in the high state during the data transmit error. Step by step test of the communication program, allows determining the instructions STXM and SRXM in error.

Attention: if the communication error occurs, then the diagnostic flag TDIA stays in high state, until the diagnostic register will not be reset to zero.

Possible corrective actions in the master station

Verify the parameters of the instructions STXM and SRXM in error. Verify that the slave address is present in the network.

Possible corrective actions in the slave station

For every instruction STXM and SRXM in error, read the slave station number and verify concerned stations.

- Verify if the *Hardware Settings* are defined correctly
- Verify if the PCD is equipped with necessary communication hardware
- Verify if the stations are connected to the network and are powered on
- Verify the network wiring
- Verify if the firmware version supports Ether-S-Bus

Diagnostic register

Diagnostic register can give us more information's about the nature the communication error. Display the binary content of the register and compare it with the descriptions of the PCD manual or the communication network manual.

11.7 Gateway Function

The *Gateway* feature is commonly used to allow two different communication networks to communicate together, or adapt a programming tool (PG5) or a supervision system (Visi+) to use a different network than the one usually supported.

11.7.1 Application

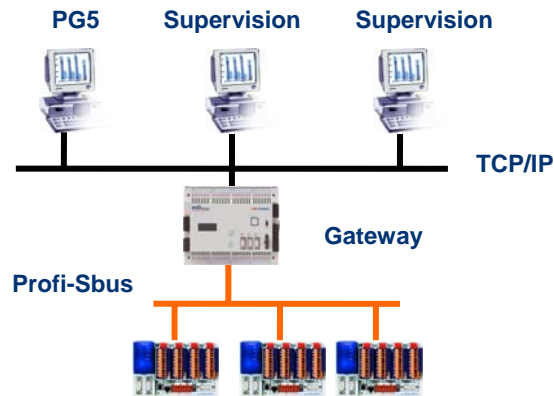

The *Gateway* function creates a bridge between two networks, for example to link an Ethernet network with a Profi-S-Bus network. In this way the PCD systems exchange data on a common bus, specific to the automation field and separated from information network of the company. But the PCs running the PG5 software or the supervision system Visi+ can exchange still data with the PCDs.

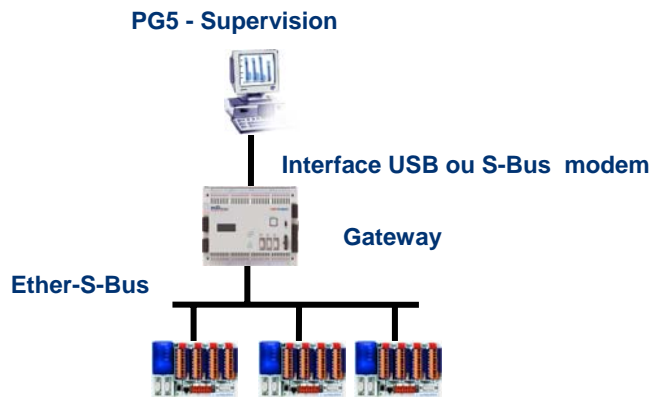

The *Gateway* function can be used as an interface between a communications network and the external world. For example, to make modem or USB communication interfaces.

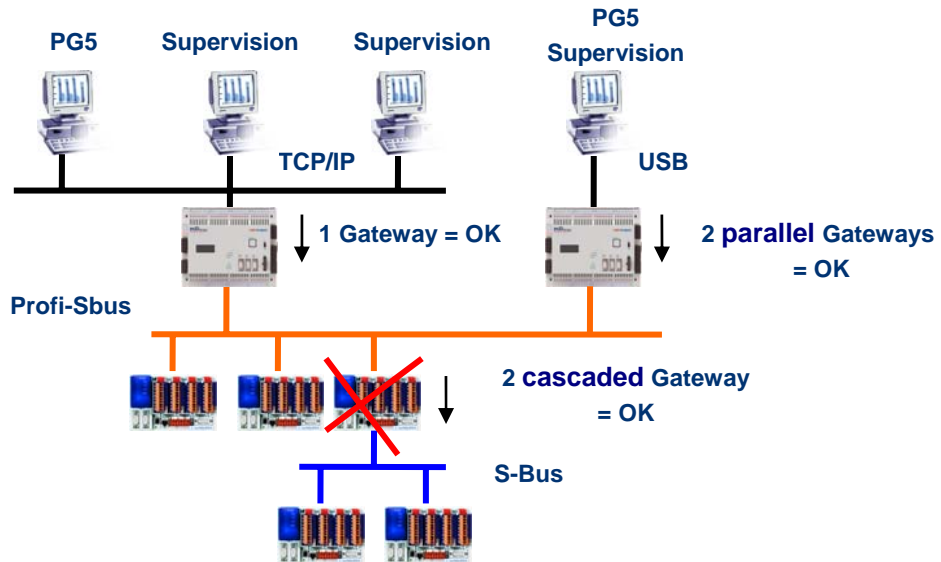

To respect the communication timings, we cannot define two cascaded Gateways functions. But it is possible to define two parallel Gateways on the same network.

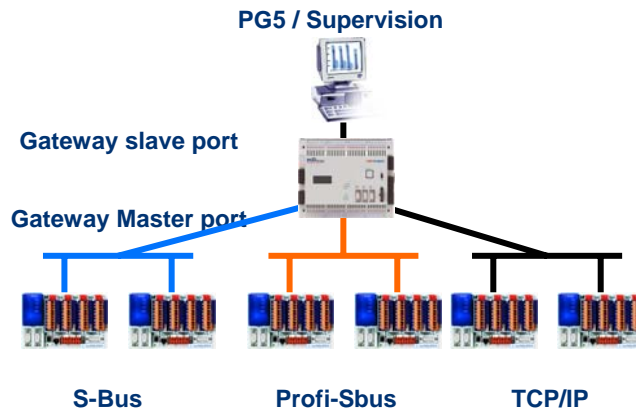

If necessary, a Gateway can make a bridge between to several communication sub networks.

11.7.2 Configuration of the Gateway PGU function

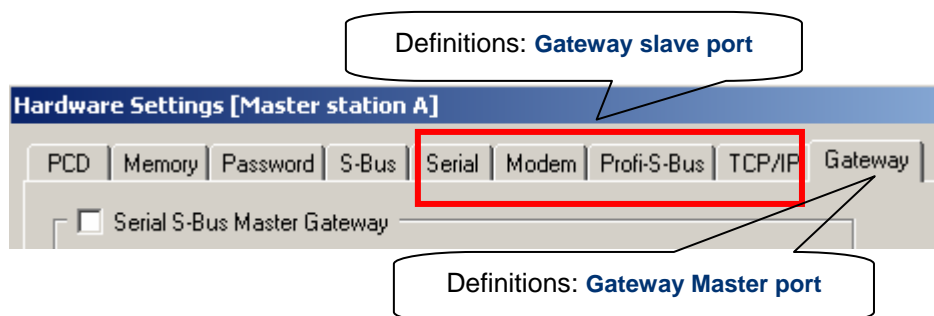

It is easy to configure the *Gateway* function; it doesn't need any program, only some parameters in the PCD *Hardware Settings*.

Generally, only a *Gateway Slave Port* and a *Gateway Master Port* should be defined, then all is automatically supported by *Gateway* function.

If the message received by the *Gateway Slave Port* is not for the local station (the *Gateway*), then data is re-transmitted via one of the sub-networks connected to the *Gateway Master Port*, according to the address ranges defined for the sub-network.

Example: Gateway USB, Ether-S-Bus

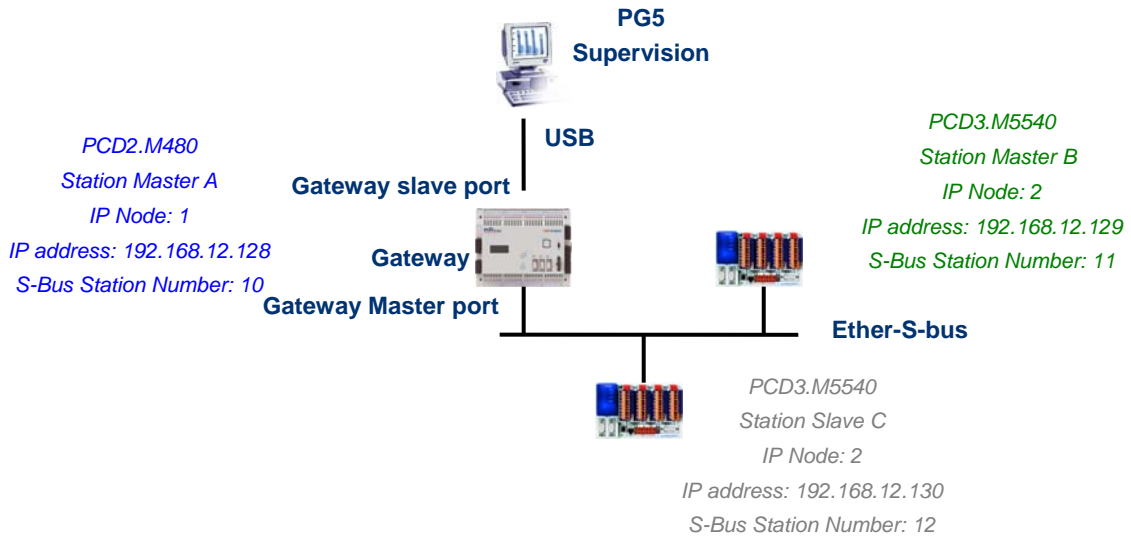

Hardware Settings of the Master A station

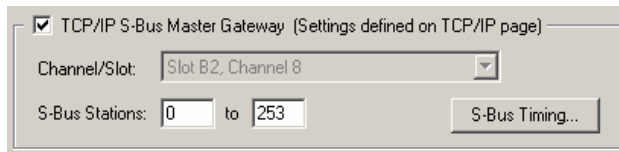

The USB Gateway is an exception; it doesn't need any parameters for the *Gateway Slave port*, only the *Gateway Master port* must be defined. (Don't forget to download the new configuration into Master A!)

Online Settings of the project CPU

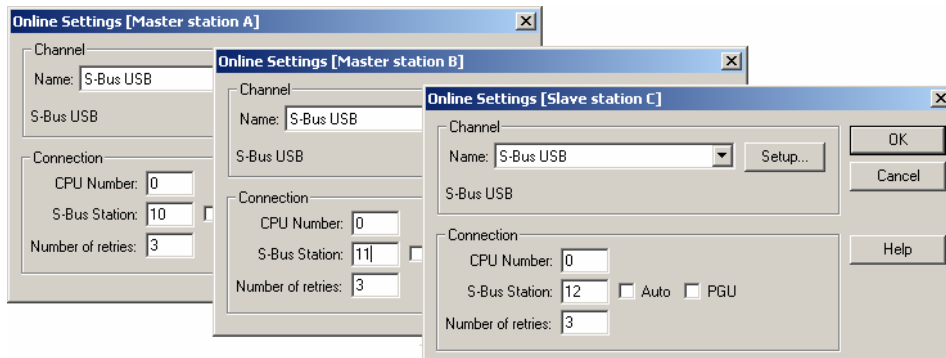

To make a USB communication with each PCD, the *Online Settings* should be configured with USB channel and S-Bus station number.

Testing the functionality of the Gateway Function

 Slave station C - PCD3.M5540 - IPNode 3, Station 12

Activate one of the CPU, *Master B* or *Slave C*, of the project and Go Online for testing the communication with the station.



If necessary, the *Online Configurator* allows you to verify the station number online. It is also possible to download the program in the active CPU and to test it, staying always connected via USB cable to station *Master A*

 Master station B - PCD3.M5540 - IPNode 2, Station 11

To communicate with another network station, activate the CPU and Go Online.

Remark:

With the *Gateway* feature, only the slave S-Bus station number is defined, the Ether-S-Bus station number is not taken into account because the telegrams are addressed to all Ether-S-Bus stations (Broadcast).

11.7.3 Configuration of the Gateway Slave port supplementary slave

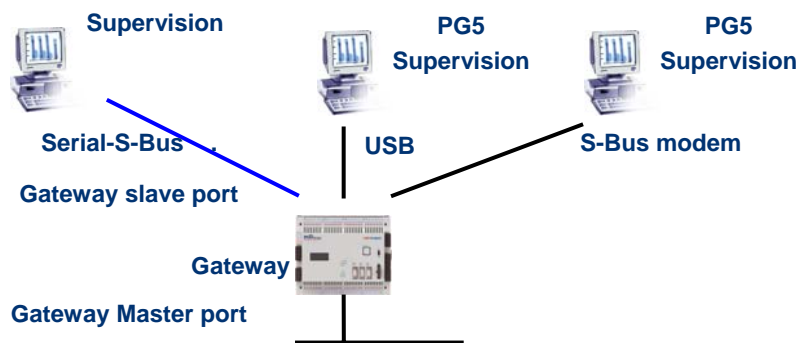

The Gateway Slave port is a way to access the network from outside. If necessary, a second or the third *Gateway Slave port* can be defined.

Hardware Settings

In general, the PCD supports only one slave PGU channel. But the new PCD2.M480 and PCD3.Mxxxx controllers may support more PGU port on the same PCD. The configuration of the second Gateway Slave PGU is supported by the *Hardware Settings*.

Example: add a second Gateway S-Bus modem, Ether-S-Bus

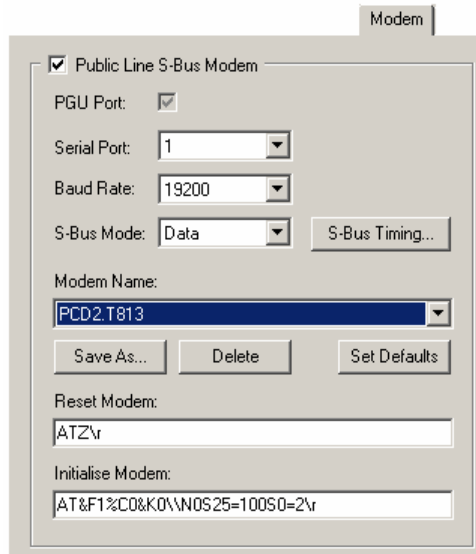

The second *Gateway Slave port PGU* is added, configuring the *Hardware Settings* with the parameters for the modem.

Fupla or IL Program

With old PCDs and also the new PCD2.M480 and PCD3.Mxxxx, it is possible to use a supplementary SASI Fbox/instruction and add a second *Gateway Slave port*.

this *Gateway slave port*, without PGU functionality, will not support the PG5 programming tools, but only a supervision system terminal. Only reading and writing PCD data are supported: registers, flags, etc.

Example Fupla: add a third Serial-S-Bus, Ether-S-Bus



The adjust *Gateway* parameter then must be defined with option *Yes*. According to channel type, the parameters of the adjust window should also correctly defined.

Example IL : add a third Serial-S-Bus, Ether-S-Bus

Use the following text to assign the channel:

```

$SASI
TEXT 11 "UART:9600; MODE:GS2; DIAG:F1110, R0501;"
$ENDSASI
    
```

Transmission speed
 Mode S-Bus Gateway Slave Data mode
 Flag and diagnostic register

11.7.4 Communication Timing

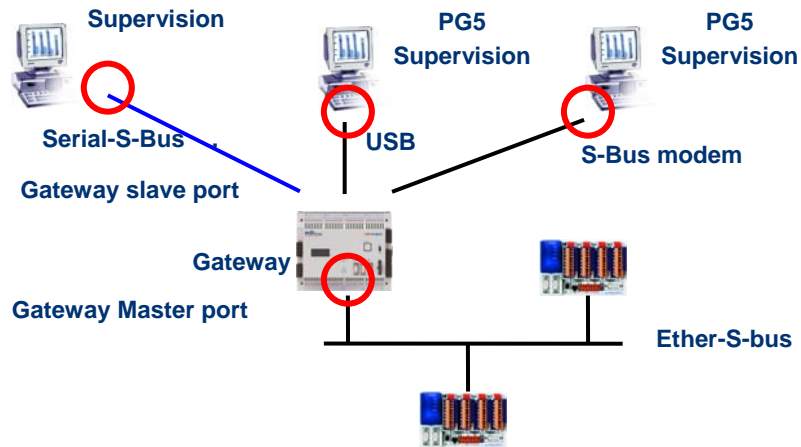

Generally the communication *timing* is defined with default values and this works correctly. But the use of the *Gateway* feature increases the times of the reactions necessary for the data exchange. It is then sometimes necessary to adjust the timeout of the master stations which use the *Gateway*. The above picture shows which are the master channels whose timeouts must be adjusted.

To adjust the *Timeout* of the PG5, use *Online Settings* of the *Master Station A*:

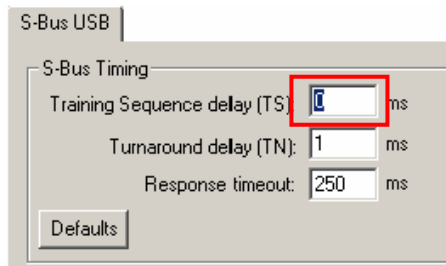

To adjust the *Timeout* of the data exchange program to the PCD, use Fbox: *SAS/ S-Bus IP Extended*



11.8 Other References

For more information's, you can also refer to the following manuals:

- Instruction Guide 26/133
- Ethernet TCP/IP 27/776
- Example of the Ether-S-Bus project installed with your PG5

Contents

CONTENTS	1
12 PROFI-S-IO	2
12.1 Profi-S-IO network example	2
12.2 General functionality	2
12.3 PG5 project	3
12.4 Defining stations on the network	3
12.5 Configuring the master station	4
12.6 Configuring slave stations	4
12.6.1 Configuring Input /Output modules	4
12.6.2 Configuring symbol names for remote data	5
12.6.3 Configuring I/O parameters	5
12.7 Configuring the network	6
12.8 Using network symbols in Fupla or IL programs	6
12.9 Further information	7

12 Profi-S-IO

This example shows how remote binary and analog inputs and outputs from the PCD3.T7xx RIO are used.

12.1 Profi-S-IO network example

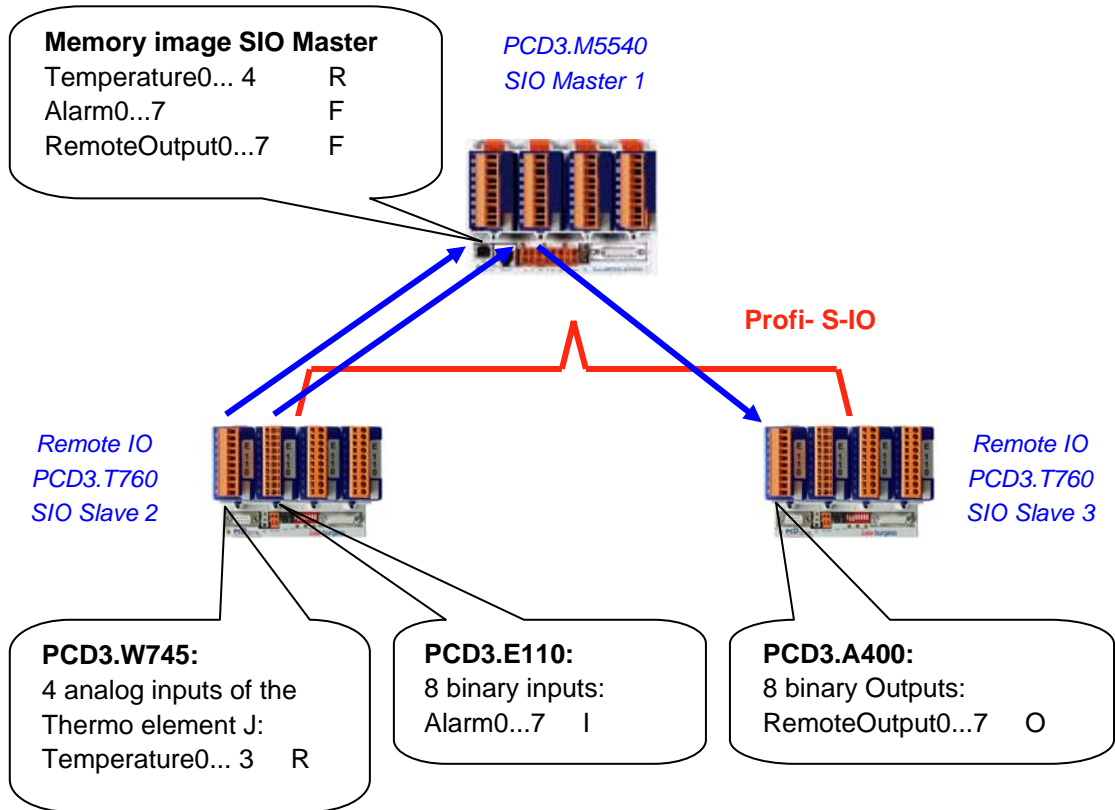

12.2 General functionality

With both Profibus DP and Profibus-S-IO, network data exchange is configured using the S-Net Configurator. No Fupla or IL code needs to be written, and no *Hardware Settings* need to be configured (apart from the communications module types and bus parameters if using the PCD2.M480 or PCD3).

The configurator defines each slave station on the network, and which I/O modules are fitted. I/O data from these remote I/Os is mapped to symbols or absolute addresses in the master station. Code generated by the S-Net configurator continually transfers I/O data from the slaves to and from the memory image in the master.

When the program is compiled, S-Net generates all the code needed to continually transfer the data between the remote slave stations and the master station's memory image at the start/end of every cycle. The I/O image data can be accessed directly by the master station's Fupla or IL programs.

In this way, network data exchange is clearly separated from the process control.

12.3 PG5 project

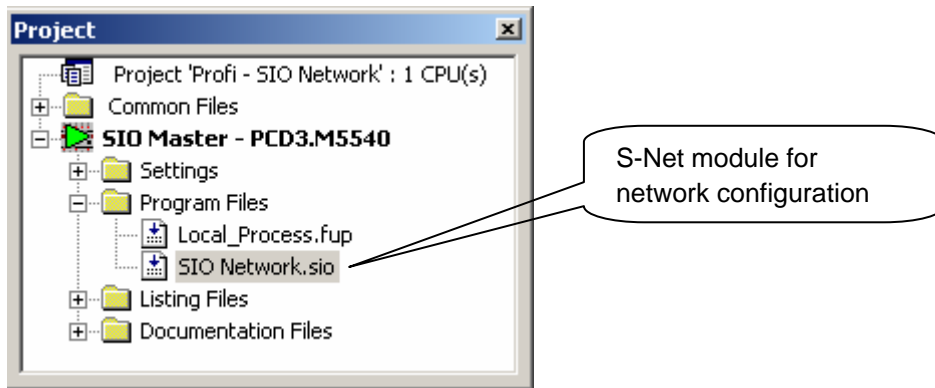

The S-Net configurator file is added to the master station in the same way as Fupla or IL files, using *File New*, selecting the "Profi-S-IO Network File (.sio)" file type.

S-Net configurator usage is similar for both Profi-S-IO and Profibus DP data exchange. The only differences are:

- File extension of the configuration: .SIO, .DP
- The supported devices in the network: SIO = Saia devices, DP = devices for Saia + other suppliers.
- Bus timing profiles: S-Net or DP.

12.4 Defining stations on the network

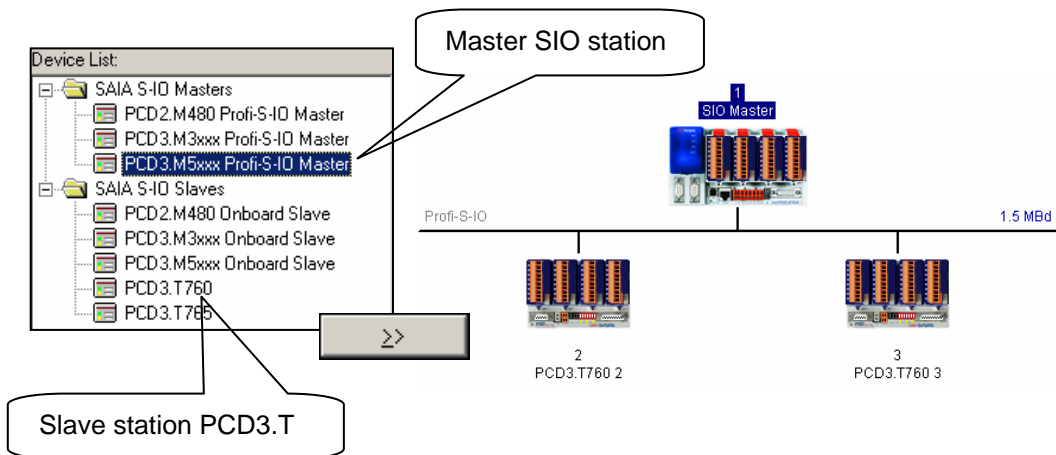

For each station, select the station type in the device list, and add it in the network with the >> button.

12.5 Configuring the master station

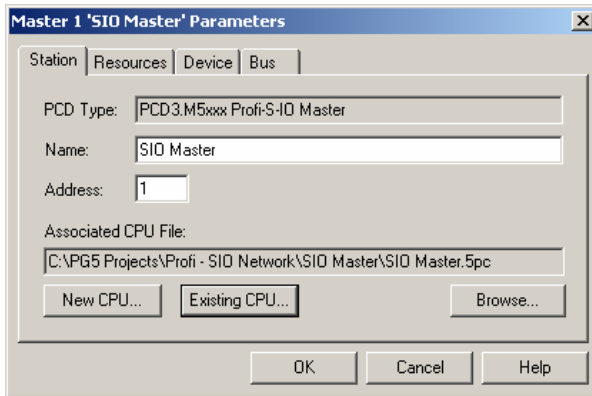

The only information which needs to be defined for the master station is the *Associated CPU File*, which is the access path of the master CPU. This where S-Net will create the master station's network control file. This dialog box also allows the station name and address to be defined.

12.6 Configuring slave stations

12.6.1 Configuring Input /Output modules

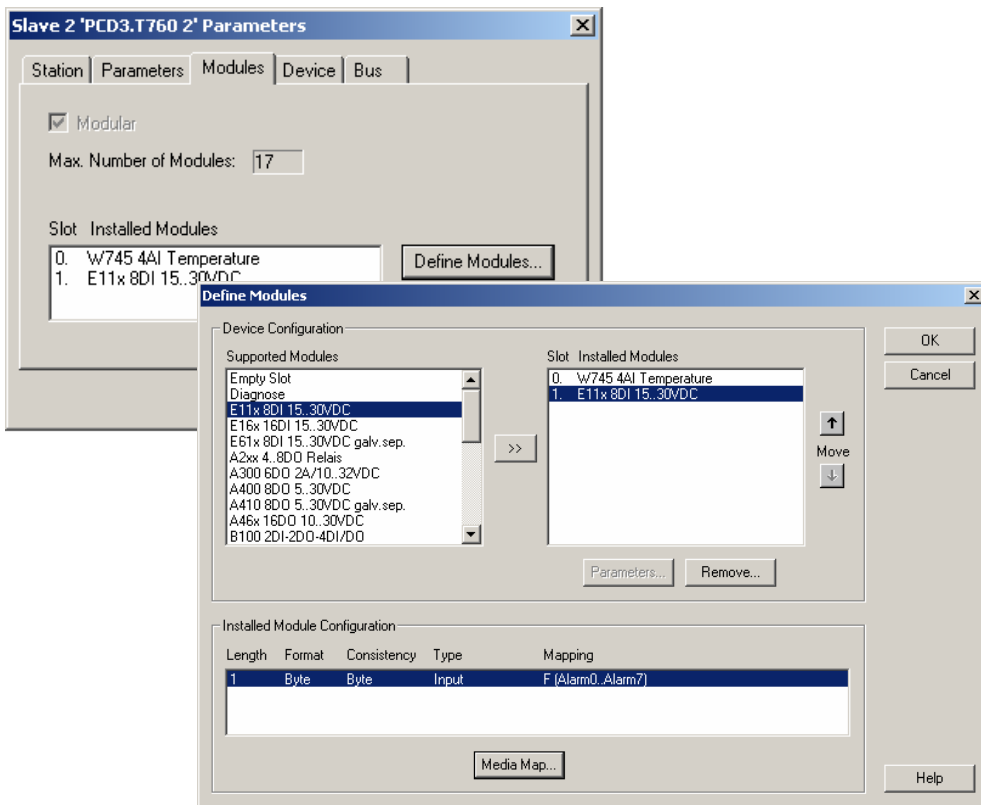

For each input/output module fitted in the slave station, select the module type in the *Supported Modules* list and add it to the *Installed Modules* list using the >> button. Ensure that the *Slot* number corresponds to the slot where the module is actually installed, use the up/down Move arrows to change the slot.

12.6.2 Configuring symbol names for remote data

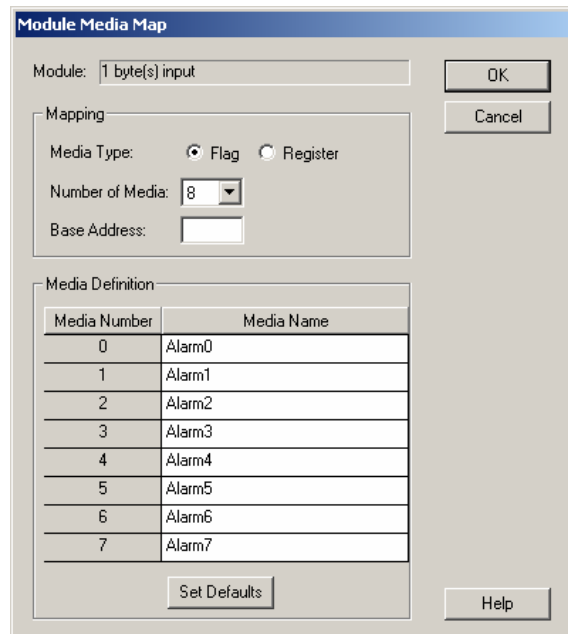

For each module in the *Installed Modules* list, select the module and press the *Media Map* button to define symbol names and media types for the module's data. If necessary, a base address for the first flag or register in the master station can be defined. But the easiest way is to leave the "Base Address" field empty, so that dynamic addresses are used.

12.6.3 Configuring I/O parameters

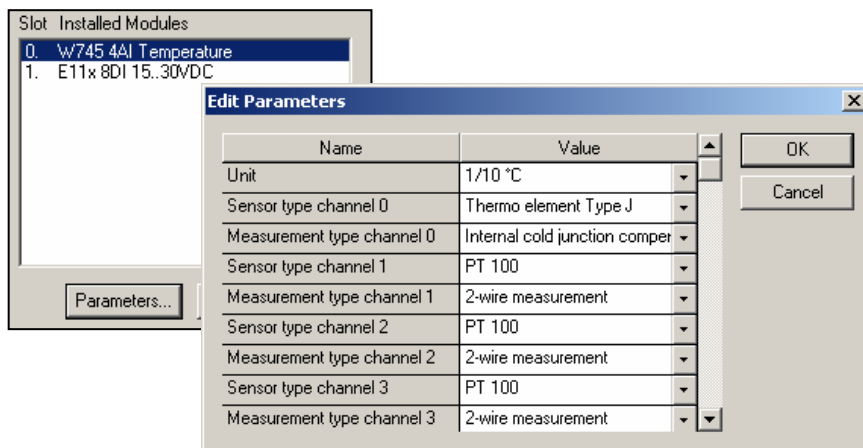

With some modules, such as analogue measurement modules, additional parameters should be defined for selecting units, sensor types etc. These are configured by selecting the module and pressing the *Parameters* button.

12.7 Configuring the network

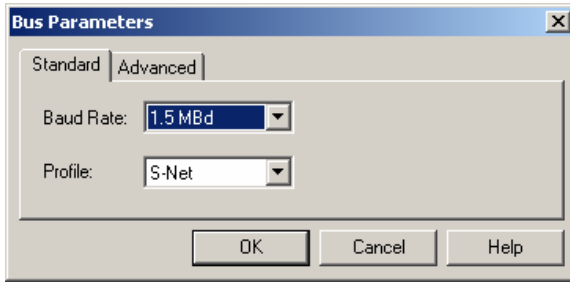

The communications speed and bus profiles are defined using the *Edit - Bus Parameters* menu command.

Note:

If a PCD7.T7xx station is connected to the network, always choose the "S-Net" bus profile.

12.8 Using network symbols in Fupla or IL programs

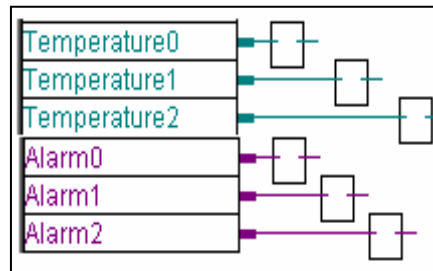
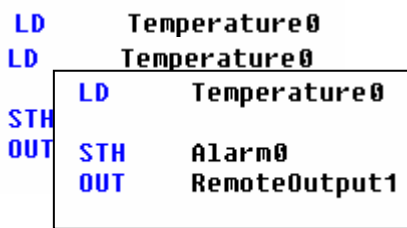
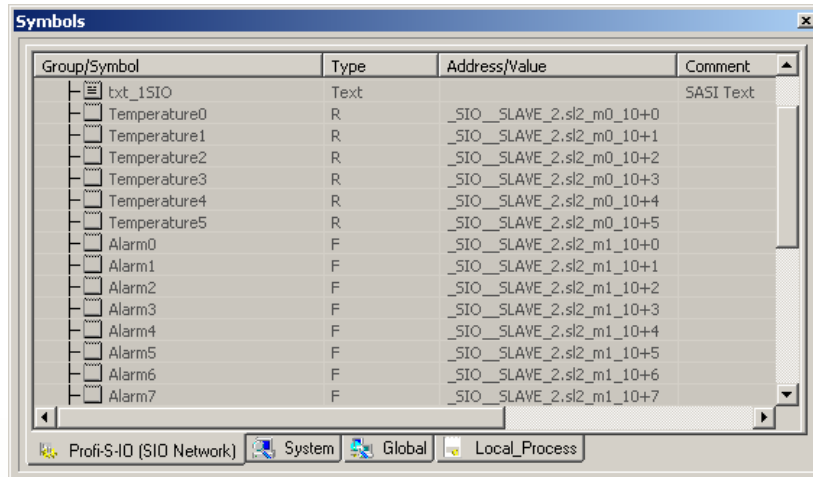

After compilation of the S-Net file (*Project / Compile* menu command), the Symbol Editor displays a new page containing the accessible network symbols. These symbols can be used directly in Fupla and IL programs.

12.9 Further information

For more information please refer to these manuals:

- Profibus DP 26/ 765
- Profi-S-IO (in preparation)
- Example Profi-S-IO project installed with your PG5

Technical data and ordering information

Technical data

Operating system	Windows 95 B Windows 98 second edition Windows NT 4.0 SP5 Windows 2000 Windows XP TCP/IP must be installed TAPI 2.0 must be installed
IBM-compatible PC	Pentium 150 or better; 32 MB RAM or more; 30 MB free hard disk; CD-ROM drive
PCD instruction set	All 150 PCD instructions are supported
Standard FBoxes	The PG5 has over 250 standard Fboxes
Modem	Basic modem configuration and communication are implemented in the PG5. Libraries with more extensive modem functions, such as SMS and Pagers are also available
Programming languages	Instruction List (IL), FUPLA (FBD) and GRAFTEC (SFC)
CPUs supported	All SAIA®PCD models are supported (excluding the xx7 Series)
Compatibility	PG3 and PG4 programs can still be used with PG5
Communication	TCP/IP, SAIA®S-Bus, PROFIBUS DP, PROFIBUS FMS and LONWORKS® communication are present in PG5.

Ordering information

Type	Description
PCD8.P59 000 M9	Complete PG5 package The package contains a licence diskette, documentation and the program on CD-ROM.
PCD8.P59 000 M1	PG5 demo package The package contains the full version of PG5, but the printing of program files has been disabled and processing restricted to programs no greater than 2000 lines in size.

saia-burgess
Smart solutions for comfort and safety

Saia-Burgess Controls Ltd.
Bahnhofstrasse 18
CH-3280 Murten / Switzerland

Telephone ++41 26 672 71 11
Telefax ++41 26 670 44 43

E-mail: pcd@saia-burgess.com
Homepage: www.saia-burgess.com
Support: www.sbc-support.ch

Saia-Burgess Controls Kft.
Liget utca 1
H-2040 Budaörs

Telephone 023 / 501 170
Telefax 023 / 501 180

E-mail: office@saia-burgess.hu
Homepage: www.saia-burgess.hu
Support: www.sbc-support.ch

Your local contact: